

| FREE

B&Q

Kitchens - Buying Guide

**NEW
LOWER
PRICE**

**Over 1000 price reductions
on Cooke & Lewis kitchens
cabinets and doors**

Friday 1st August – Thursday 11th September

Welcome...

This Kitchen Buying Guide works in conjunction with our B&Q Kitchen Ideas Book.

The Buying Guide gives you precise details about every kitchen product – choice, description, specification, price and availability. Combined with the inspirational Ideas Book you'll have everything you need to make the perfect choice for your kitchen.

If you do need any additional help, our trained in-store advisors will be happy to give you further advice.



Contents

   **pages 12 – 24**

 **Clic Kitchens**  **pages 25 – 28**

 **Kitchens**  **pages 29 – 45**

Handles **pages 46 – 48**
Worktops **pages 49 – 60**
Splashbacks **pages 61 – 63**
Sinks **pages 64 – 76**
Taps **pages 77 – 84**
Storage **pages 85 – 92**
Lighting **pages 93 – 94**
Appliances **pages 95 – 149**

How to select your kitchen

Step 1 Pick your cabinets, drawer boxes and appliance housing

Step 2 Pick your open cabinets and end panels

Step 3 Pick your doors, drawer fronts, fixed frame doors, colour matched accessories and hinges

Each door and drawer front is labelled alphabetically to help you work out which you will need

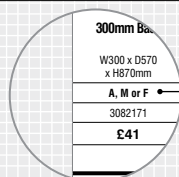

Cabinet tables indicate your door and drawer front options

Step 4 Pick your finishing accessories, end panels, cornices and plinths

Step 5 Pick your sink, taps, handles, worktops and appliances

Availability and delivery



Take home today ranges

Ranges featuring this symbol are available to take away (dependent on stock). Please check availability with your local store. Each store stocks a selection from our take away range. If an item is not in stock your local store will be able to order it for you.



Home delivery ranges

Ranges featuring this symbol can be delivered direct to your home. In addition to the IT take home today ranges we offer an extended collection of IT kitchens not found in store. Cooke & Lewis kitchens can only be ordered in-store for home delivery.



Our Banbury, Bedford, Burgess Hill, Bognor Regis, Consett, Eastleigh, Fareham, Hedge End, Nursling, Poole, Portsmouth, Port Glasgow and Sydenham stores stock a wide range of products – all available to take away. The symbol is used throughout this Buying Guide to indicate the products that these stores stock. However these are subject to availability and ranges may vary by store.

Orders over £250 are delivered FREE. Delivery times vary depending on the product so please ask at the time of ordering. Delivery charges are on page 151.

Can't get it home? Van hire from £14 per hour – see in store for details

Always lowering the cost



Our price promise

If you find any products even 1p cheaper somewhere else, we'll refund the difference and give you an extra 10% off the lower price. Take a look at page 135 for details.

Independently PRICE CHECKED

We're confident that our prices are consistently low every week. See the results for yourself at:

kitchen-compare.com
and bathroomcompare.com

Why pay more?

Lowering costs, never compromising on quality

This is at the heart of what we stand for... At B&Q we're able to offer you exceptional quality products and ranges at low prices. We offer fair and honest pricing that our customers can trust and unlike other companies, we'll never artificially inflate prices only to slash them later in the year to appear as a great money saving deal. This is simply dishonest and unfair on you.

10 year product guarantee

We're unlike other companies who's guarantees fall apart in the small print!

Built to last, for your peace of mind

We offer a 10 year guarantee on all of our kitchens and bathrooms. Our product teams take a great deal of time and care to research and source the very best ranges for us to put our B&Q name to. It's crucial that we bring you excellent quality and reliable products. We sell hundreds of thousands of kitchens, bedrooms and bathrooms to go into homes across the UK every year and have to make sure that what you buy from us is fit for purpose and of the highest possible quality.

We only choose the leading manufacturers who are best in class. They use high grade materials and carry out rigorous testing to British and European standards so we can offer them with confidence and with long guarantees.



B&Q

Homefit

APPROVED tradesmen - fixed prices

Helping you with your project

Your step-by-step guide of what to expect...

The whole idea of the project may seem daunting but we're here to make it easy, and most importantly, enjoyable. We promise to do everything we can to ensure your project runs smoothly at every stage of the journey.

1. Inspiration

So what is it you're looking to do? Repair, refresh, maintain or get something totally new? We can inspire you with great ideas that suit you, your budget and your lifestyle. You may even need help with financing and installation which we will discuss with you.



2. Planning

Once inspired, we'll need you to get a few simple room measurements to help us move forward with your project. It's really simple and we'll give you guidance on how to measure, plan and make the best use of your space.



4. Create the look

You will now have a clear vision of your kitchen, bedroom or bathroom. You may want to look at how you can personalise your room and make it truly yours. Whether that's lighting, flooring, tiling, colour schemes or accessories, we have everything you'll need to create your desired look. We can even help you tile, lay flooring, paint and more so you don't have to.



3. Designing

With our totally free design consultation, we will bring your ideas to life with our leading 3D design software. We'll also need to look at heating, plumbing and electrics to see if they are affected by the project.



5. Budgeting

Following our survey, we will know exactly how much the project will cost you. But rest assured, our prices won't be beaten, and that's a promise. Check out our flexible finance options.



6. Installing

Your kitchen, bedroom or bathroom is ready to take its place in your home. Whether you've chosen to have it fully installed by our market leading installation service or just to have items delivered through our flexible delivery options, we'll make things easy and provide helpful advice at every stage. We can even help you with great tips to install yourself, either the full project or parts of it.



Market leading

5 year installation guarantee

Professionally fitted

Deciding which kitchen, bedroom or bathroom is perfect for you is one thing, but we know that not everyone has the time or experience to install it themselves. We can take care of your project from installation to plumbing, electrics, gas works, flooring, plastering, tiling and joinery. With over 15 years of domestic installation experience, over 1/2 million completed projects and international accreditation, you're in safe hands, we're the most experienced national retailer in the UK.

All projects are managed locally so you'll always have somebody close by to contact if you need any help or advice. Once the work has been completed, and we've checked that you're happy, you will receive a 5 year workmanship guarantee; **the best of any national retailer in the UK today.**

Kitchens, bedrooms & bathrooms



Our installation service is audited and has best practice relationships with...



ISO 9001:2008 FS 551578

You're in safe hands

Helpful 'How to Measure' tips and advice for your kitchen

1

The overall room layout

- Sketch the outline of your room
- All you require is the general shape

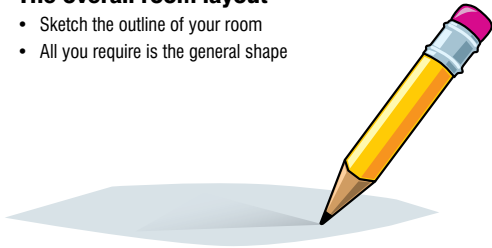

2

Indicate openings – windows, doors, archways and hatched

- Mark the location of windows, doors, archways, hatches
- Include the opening swing of doors

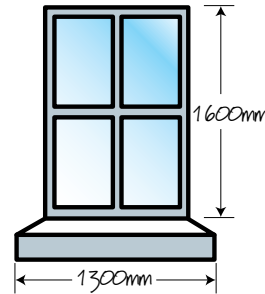

3

Indicate any obstacles that can't be moved and include main services, electric, water and gas

- Indicate items that must be planned around
- Your boiler, meters, radiators, soil stack, stop cock, alcoves, etc
- Finally add main services, electric, water and gas

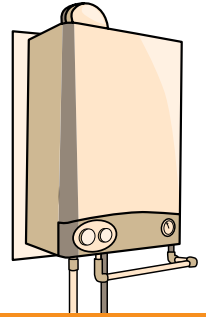

4

Measure between each fixed point – doors, walls and windows

- Pick a logical starting point like a corner and work clockwise around the room to avoid missing anything
- When measuring doors and windows remember to include frames and architrave, together with the distance from the floor to the underside of the windows

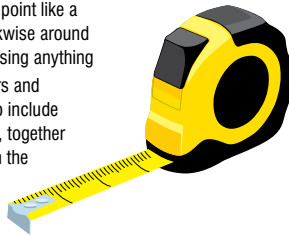

5

Measure obstacles in the room

- Your soil stack and boiler, radiators, etc
- Remember to include the width, depth and height of each item
- Show the obstacle heights and their distance from the floor in mm e.g. H=700mm F=1200mm

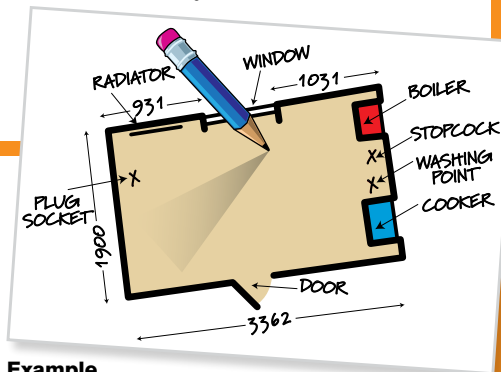

6

Measure main services, electric, water and gas

- Measure from the nearest fixed point on your diagram to the centre line of each service
- Include sockets, phone, gas, water and TV points
- When measuring larger service items such as consumer units, gas meters and radiators, remember to include their width and height from the floor



7

Measure ceiling heights

- Take two or three measurements to ensure the ceiling is consistent and mark the height in the middle of your survey plan
- If there are obstacles on the ceiling such as a stair slope or landing, mark this on your sketch

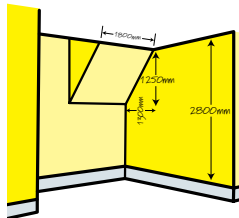

8

Example

Your sketch should look something like the example shown above. Now you're ready to start stage two of your project – Planning at B&Q

Helpful tips

- Remember walls aren't always perfectly square, so measure them at the top, middle and bottom.
- Bear in mind that switches, sockets and most radiators can be moved – you can discuss this with your B&Q designer.
- If you're keeping any freestanding appliances or furniture like tables and chairs, include their dimensions for your design consultation.
- Take photos of any particular feature or bits you're unsure about.
- Include for discussion any structural alterations you may want to make like moving doors.
- Once you've finished, double check your measurements for accuracy as this will make it easier to create your new project.

B&Q

Homefit

APPROVED tradesmen - fixed prices

You're in safe hands

Helpful 'How to Measure' tips and advice for your kitchen

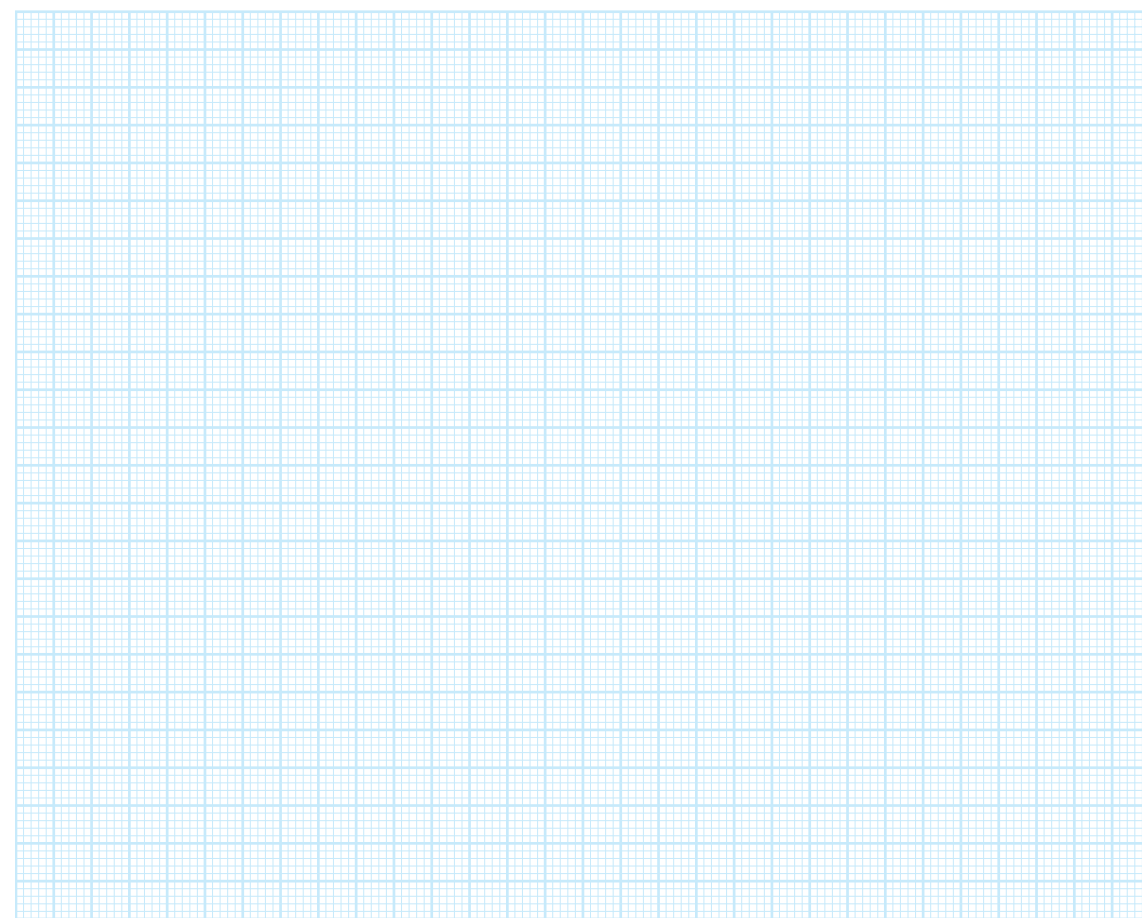

Checklist – have you...

- | | | | |
|--------------------------|---|--------------------------|---|
| <input type="checkbox"/> | • Drawn the shape of your room? | <input type="checkbox"/> | • Indicated width, depth and height of all obstacles? |
| <input type="checkbox"/> | • Drawn the location of the doors and windows? | <input type="checkbox"/> | • Indicated sockets, phone and TV points? |
| <input type="checkbox"/> | • Planned around any obstacles that can't be moved? | <input type="checkbox"/> | • Measured the ceiling height correctly? |
| <input type="checkbox"/> | • Added the main services, electric, water and gas? | <input type="checkbox"/> | • Measured any free-standing items such as furniture? |

When are you looking to change your room?

What are you looking to change?

- | | | | |
|------------------|--------------------------|-------------------|--------------------------|
| Complete project | <input type="checkbox"/> | Refresh | <input type="checkbox"/> |
| New doors | <input type="checkbox"/> | New cabinets | <input type="checkbox"/> |
| New worktops | <input type="checkbox"/> | New handles | <input type="checkbox"/> |
| New appliances | <input type="checkbox"/> | New sanitary ware | <input type="checkbox"/> |
| Other | | | |

Have you considered...

- | | | | |
|-------------|--------------------------|------------|--------------------------|
| Accessories | <input type="checkbox"/> | Sinks/Taps | <input type="checkbox"/> |
| Tiling | <input type="checkbox"/> | Heating | <input type="checkbox"/> |
| Lighting | <input type="checkbox"/> | Flooring | <input type="checkbox"/> |

Would you be interested in B&Q's finance options?

- Yes No

Who is installing your kitchen?

- | | |
|---------------------------------|--------------------------|
| I'd like B&Q to give me a quote | <input type="checkbox"/> |
| Local Tradesman | <input type="checkbox"/> |
| Myself | <input type="checkbox"/> |

Planning for corners

Base corner cabinets

Closed corner

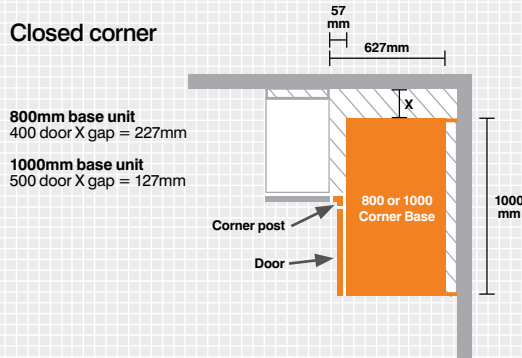

'L' Shaped corner

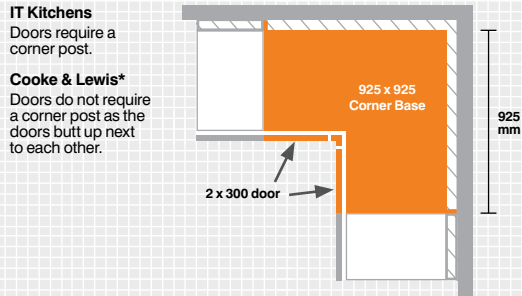

Curved internal corner

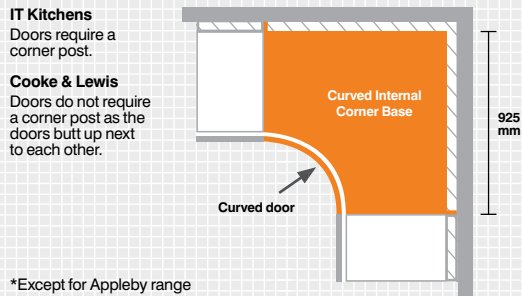

*Except for Appleby range

Wall corner cabinets

Closed corner

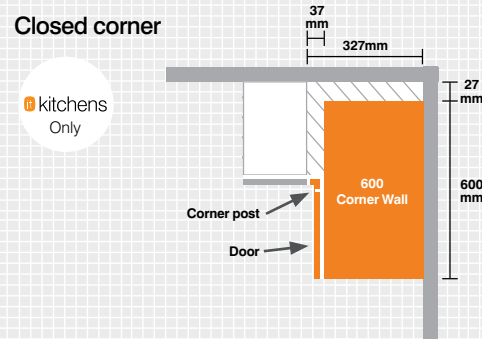

Diagonal corner

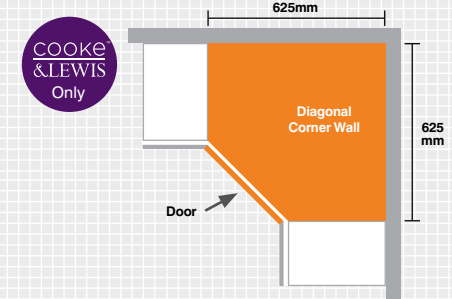

'L' Shaped corner

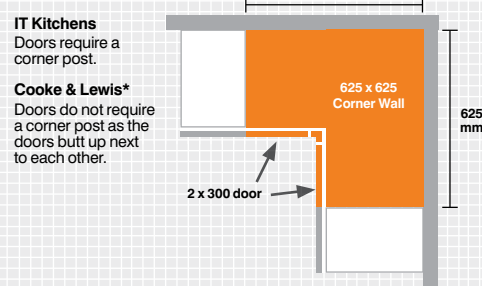

Curved internal corner

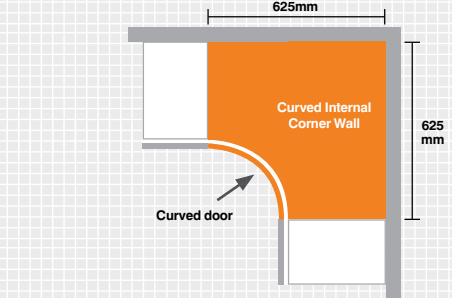

Finishing touches

What you'll need to add the finishing touches to your dream kitchen

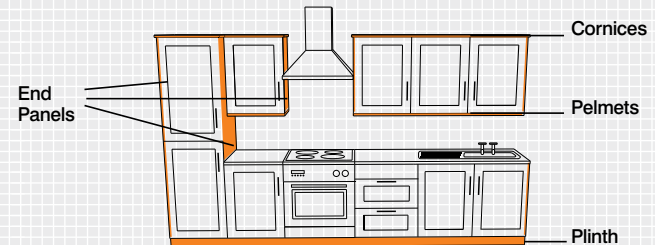

top tip...

This guide will help you choose the door packs that you'll need to complete larder cabinets and appliance housings.

Key

E* These refer to the door packs you'll need to complete each unit.

Larder cabinets

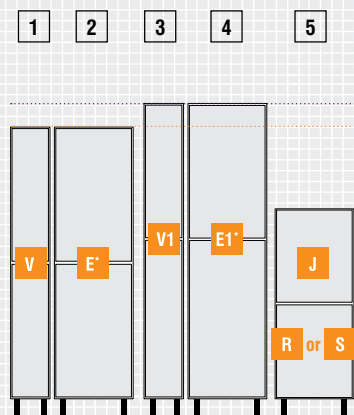

Fridge freezer cabinets and pull-out storage

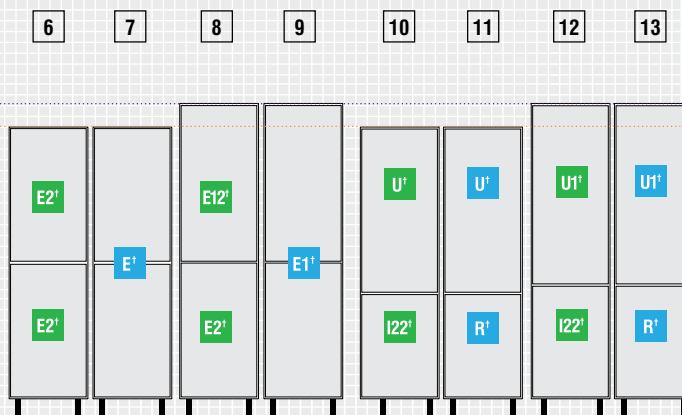

Single oven units

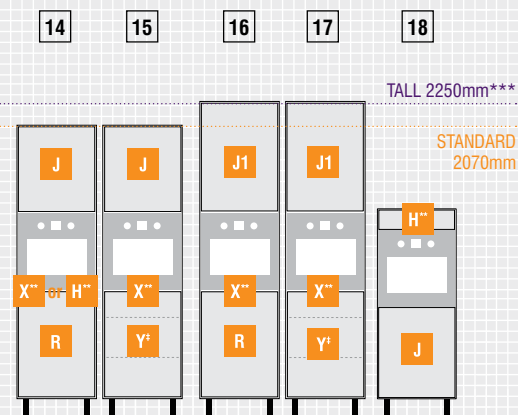

For larder cabinets

- 1 For a 300mm wide standard larder cabinet you need door pack V. (Pack V contains 2 doors)
- 2 For a 600mm wide standard larder cabinet you need door pack E*. (Pack E contains 2 doors)
- 3 For a 300mm wide tall larder cabinet you need door pack V1. (Pack V1 contains 2 doors)
- 4 For a 600mm wide tall larder cabinet you need door pack E1*. (Pack E1 contains 2 doors)
- 5 For a 600mm wide mid-height larder cabinet you need door pack R or S and door pack J.

Larder cabinets with framed doors do not allow unrestricted full height access and must be fitted with a central shelf.

For integrated 50/50 fridge freezer cabinets and pull-out storage

- 6 For a standard height 50/50 cabinet in **framed** kitchens you need door pack E2* x 2.
- 7 For a standard height 50/50 cabinet in **non-framed** kitchens you need door pack E1*. (Pack E contains 2 doors)
- 8 For a tall height 50/50 cabinet in **framed** kitchens you need door pack E12* and door pack E2*.
- 9 For a tall height 50/50 cabinet in **non-framed** kitchens you need door pack E1*. (Pack E1 contains 2 doors)

For integrated 60/40 and 70/30 fridge freezer cabinets and pull-out storage

- 10 For a standard height 60/40 or 70/30†† cabinet in **framed** kitchens you need door pack U* and door pack I22*.
- 11 For a standard height 60/40 or 70/30†† cabinet in **non-framed** kitchens you need door pack U1* and door pack R1*.
- 12 For a tall height 60/40 or 70/30†† cabinet in **framed** kitchens you need door pack U1* and door pack I22*.
- 13 For a tall height 60/40 or 70/30†† cabinet in **non-framed** kitchens you need door pack U1* and door pack R1*.

For single oven housing units

- 14 For a standard height 600mm wide single oven housing unit you need door pack J, door pack R and pack X** (Cooke & Lewis only) or pack H**.
- 15 Cooke & Lewis only – for a standard height 600mm wide single oven housing unit with pan drawers you need door pack J, door pack Y† and pack X**.
- 16 For a tall height 600mm wide single oven housing unit you need door pack J1, door pack R and oven housing filler pack X**.
- 17 For a tall height 600mm wide single oven housing unit you need door pack J1, oven housing filler pack X** and door pack Y† for a drawer cabinet.
- 18 For a 600mm wide mid-height unit for a single oven you need door pack H** and door pack J.

* If buying a pull-out larder frame product for this cabinet see illustrations 6 – 13 for door choices.

† Please note there are different options of fridge/freezer unit door combinations – this is dependent on your chosen kitchen style.

†† For a 70/30 fridge freezer you need to raise the appliance by using one of the shelves supplied.

‡ Please note there are different options of drawer boxes for drawer packs Y and BB this is dependent on your chosen kitchen style.

** Pack X or H oven housing filler panel can be added to accommodate various single oven heights.

*** Tall sizes are only available for the Cooke & Lewis ranges.

Double oven units

Oven and microwave units

For built-under cabinets and integrated appliances

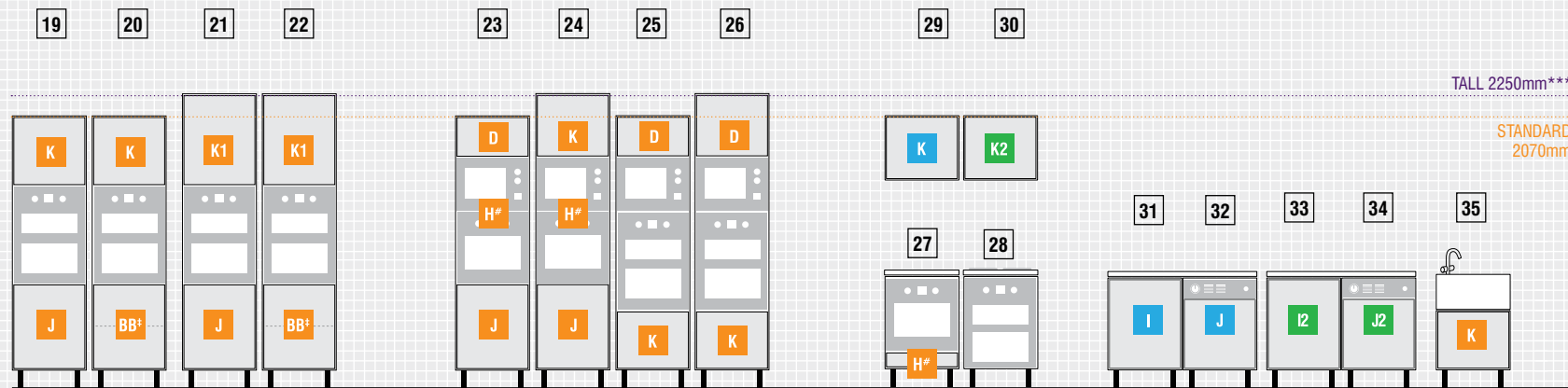

For double oven housing units

- 19** For a standard height 600mm wide double oven housing unit you need door pack K and door pack J.
- 20** Cooke & Lewis only – for a standard height 600mm wide double oven housing with pan drawers you need door pack K and door pack BB#.
- 21** For a tall height 600mm wide double oven housing unit you need door pack K1 and door pack J.
- 22** For a tall height 600mm wide double oven housing unit you need door pack K1 and door pack BB# for a drawer cabinet.

For single oven and microwave housing units

- 23** For a standard height 600mm wide single oven and microwave housing unit you need door pack D and door pack J. (Don't forget that in Cooke & Lewis you can substitute pack J with pack BB to create a 2 drawer cabinet if preferred).
- 24** For a tall height 600mm wide single oven and microwave housing unit you need door pack K and door pack J. (Don't forget that in Cooke & Lewis you can substitute pack J with pack BB to create a 2 drawer cabinet if preferred).

For double oven and microwave housing units

- 25** For a standard height 600mm wide built-under double oven and microwave housing unit you need to select your door packs based on the size of the microwave being used. This example (shown above) uses a 450mm height microwave with door pack D and door pack K.
- 26** For a tall height 600mm wide built-under double oven and microwave housing unit you need to select your door packs based on the size of the microwave being used. This example (shown above) uses a 450mm height microwave with 2 x door pack K.

For built-under cabinets

- 27** For a 600mm wide built-under single oven you may need door pack H# to accommodate variations in the height of your appliance.
- 28** No doors are required for a 600mm wide built-under double oven.
- 29** For a 600mm wide extractor hood unit with **non-framed** doors you need door pack K.
- 30** For a 600mm wide extractor hood unit with **framed** doors you need door pack K2.

For integrated appliances (including fridges, freezers, washing machines and tumble dryers)

- 31** For a 600mm wide integrated dishwasher cabinet in **non-framed** kitchens you need door pack I.
- 32** For a 600mm wide semi-integrated dishwasher in **non-framed** kitchens you need door pack J.
- 33** For a 600mm wide integrated dishwasher cabinet in **framed** kitchens you need door pack I2.
- 34** For a 600mm wide semi-integrated dishwasher in **framed** kitchens you need door pack J2.

For Belfast sinks

- 35** For a 600mm wide Belfast sink unit you need door pack K.

‡ Please note there are different options of drawer boxes for drawer packs Y and BB this is dependent on your chosen kitchen style.
 # Door packs to be selected based on the size of the appliances being used. Pack H oven filler panel can be cut to size to accommodate various appliance heights. When placing one appliance above another you may wish to use filler panel H in between.
 *** Tall sizes are only available for the Cooke & Lewis ranges.

All of our B&Q kitchen cabinets are designed to bring you a high specification at a great price. With Cooke & Lewis and Cooke & Lewis Clic, there are even more features, benefits and choice

it kitchens

- White with coffee bean interior cabinets
- Wall cabinets come with 2 shelves, base cabinets come with 1 shelf
- Adjustable visible hanging brackets
- Soft close door and drawer upgrade available

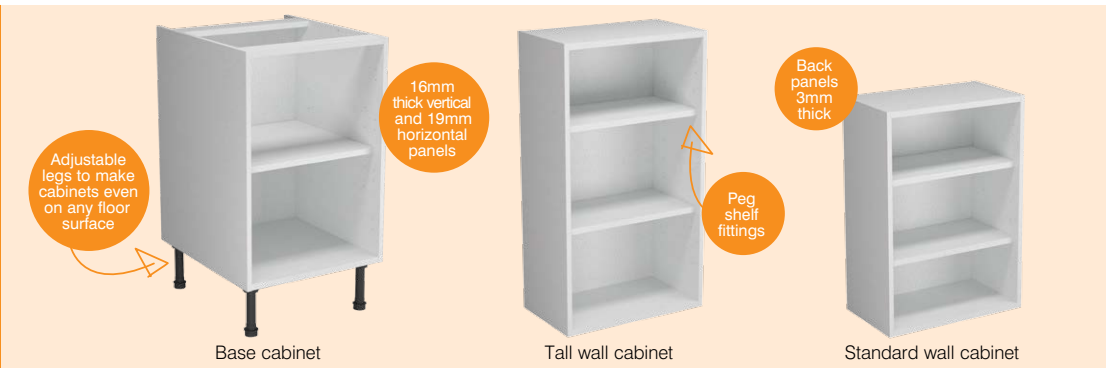

COOKE & LEWIS Clic Kitchens

- Easy to assemble, no tools required
- Up to 3 times faster to construct than our flat-packed cabinets
- No visible fixings
- Available in white and oak finishes























COOKE & LEWIS Kitchens











- Soft close doors and drawers
- Choice of cabinet colours
- Higher quality fittings
- Deeper wall cabinets
- Takes full size dinner plates
- Available in white and oak finishes



Cabinet features at a glance

	INSTALLATION	COLOUR OPTIONS	WALL CABINET OPTIONS	DRAWERS	SOFT CLOSE	PANEL THICKNESS	HINGES	SHELF FITTINGS	HANGING BRACKETS
									
	Self-assembly fittings	White cabinet only	2 height with 2 shelves	Metal inset drawer box offered on standard	Soft close upgrade available	16mm Vertical panels. 19mm Horizontal panels.	Screw-in, adjustable (Soft close upgrade available)	Peg style	Sturdy, visible brackets

	INSTALLATION	COLOUR OPTIONS	WALL CABINET OPTIONS	DRAWERS	SOFT CLOSE	PANEL THICKNESS	HINGES	SHELF FITTINGS	HANGING BRACKETS
 <p>3x FASTER</p> <p>Up to 3 times faster to construct than flat - pack</p> 									
	Easy to assemble. No tools required.	Choose white or oak effect Meets BS6222 level H	Choose from 2 heights with 2 or 3 shelves	High specification stainless steel drawer box	Soft close hinges and drawers	Tool - less solid centre-post with a unique turn fastener technology. 8mm solid back, 18mm thick MFC panels, 1mm ABS on leading edges	Quick, easy, clip-on with 3-way adjustment. Soft close	Secure fixing Reinforced metal and plastic fitting Prevents damage	Tool - less and adjustable hanging bracket system

	INSTALLATION	COLOUR OPTIONS	WALL CABINET OPTIONS	DRAWERS	SOFT CLOSE	PANEL THICKNESS	HINGES	SHELF FITTINGS	HANGING BRACKETS
									
	Pre-inserted fittings for ease and speed	Choose white or oak effect Meets BS6222 level H	Choose from 2 heights with 2 or 3 shelves	High specification stainless steel drawer box	Soft close hinges and drawers	8mm solid back, 18mm thick vertical MFC panels, 1mm ABS on leading edges	Quick, easy, clip-on with 3-way adjustment. Soft close	Reinforced and fully secured	Neat, concealed brackets

Base cabinets



Base cabinets are designed to fit all of the IT Kitchen range. Prices are for the cabinet, feet and standard hinges only. All fixtures (including doors and handles) need to be bought separately.

Standard base cabinets Heights of units are when it is constructed including legs.				You will also need		
				For full height door	For drawerline door and drawer front	For Glazed door
	150mm Base ▲ Includes pull-out rack W150 x D570 x H870mm *	3082478	£52	L	n/a	n/a
	300mm Base ▲ W300 x D570 x H870mm	3038482	£23	A	M	F
	400mm Base ▲ W400 x D570 x H870mm	3082454	£25	N	P	n/a
	500mm Base ▲ W500 x D570 x H870mm ‡	3038499	Was £30 Now £28	B	Q	G
	600mm Base ▲ W600 x D570 x H870mm	3082430	Was £34 Now £32	R	S	n/a
	800mm Base ▲ W800 x D570 x H870mm **	3279946	£36	For straight run N x 2 or P x 2 For corner unit N or P x 1 Plus base corner post x 1		
	1000mm Base ▲ W1000 x D570 x H870mm **	3166888	Was £40 Now £38	For straight run B, Q or G x 2 For corner unit B, Q or G Plus base corner post x 1		

Oven housing and Belfast sink				You will also need		
				For oven housing filler panel		
	600mm Oven housing base cabinet ▲ W600 x D570 x H870mm	White	3038505	Was £35 Now £33	Door pack H	
	Belfast sink cabinet ▲ W600 x D570 x H617mm	White	3279960	£36	Door pack K	

* Replacement end panels will not fit this product. ** Also suitable for corners and sink tops.

Multi-drawer base cabinets				You will also need		
				For full height door	For drawerline door and drawer front	For Glazed door
	500mm 3 drawer base W500 x D570 x H870mm †† HD only	5397007140880	Was £30 Now £28	n/a	C plus a 500mm drawer	n/a
	600mm 3 drawer base W600 x D570 x H870mm †† HD only	5397007140897	Was £34 Now £32	n/a	Y plus a 600mm drawer	n/a
	800mm drawer base ▲ W800 x D570 x H870mm * ††	3082317	Was £38 Now £36	Pack T for pan drawers Plus an 800mm pan 3 drawer box pack (see page 30)		
	1000mm drawer base ▲ W1000 x D570 x H870mm ††	3166888	Was £40 Now £38	Z x 2, ZA x 2 or Z x 1 & ZA x 1 Plus a 1000mm pan drawer box pack (see page 30)		

Corner base cabinets				You will also need		
				For full height door		
	925 x 925mm Corner base ▲ W925 x D925 x H870mm	3166949	£66	NF A x 2 or M x 2 (see page 28) Plus corner post for 925 base F EE x 1 No corner post required		
	Curved Internal Corner base ▲ W925 x D925 x H870mm	5397007128185	£76	CV3		
	Curved external Corner base ▲ W300 x D570 x H870mm	5397007128215	£36	CV2		
	800mm Base W800 x D570 x H870mm **	3279946	Was £38 Now £36	For straight run N x 2 or P x 2 For corner unit N or P x 1 Plus base corner post x 1		
	1000mm Base ▲ W1000 x D570 x H870mm **	3166888	Was £40 Now £38	For straight run B, Q or G x 2 For corner unit B, Q or G Plus base corner post x 1		
	Blanking panel for 1000mm corner white	5397007140903	£10			

Wall cabinets



Wall cabinets are designed to fit all of the IT Kitchen range. Prices are for the cabinet, wall brackets and standard hinges only. All fixtures (including doors and handles) need to be bought separately.

Standard wall cabinets				You will also need	
				For full height door, door pack	For Glazed door
	300mm Wall ▲ W300 x D290 x H720mm	3038536	£19	A	F
	400mm Wall ▲ W400 x D290 x H720mm	3082171	£21	N	N/A
	500mm Wall ▲ W500 x D290 x H720mm	3038543	Was £25 Now £23	B	G
	600mm Wall ▲ W600 x D290 x H720mm	3082461	Was £28 Now £26	R	N/A
	800mm Wall ▲ W800 x D290 x H720mm	3279953	Was £36 Now £34	N x 2	N/A
	1000mm Wall ▲ W1000 x D290 x H720mm	3038574	Was £37 Now £35	B x 2 or G x 2	N/A

Wall corner cabinets				You will also need	
				For full height door, door pack	For glazed door, door pack
	625 x 625 Corner wall ▲ W625 x D625 x H720mm	3166864	£59	NF A x 2 (see page 28) plus corner post for 625 wall unit F DD x 1 No corner post required	
	Curved Internal Corner wall unit ▲ W625 x D625 x H720mm	5397007128192	£69	CV4	
	Curved external wall ▲ W300 x D290 x H720mm	5397007128208	£30	CV1	
	600mm Wall corner ▲ Suitable for non-framed doors only W600 x D290 x H720mm *	3082331	£35	A or F**	N/A Plus wall corner post

Tall wall cabinets				You will also need	
				For full height door, door pack	For Glazed door
	300mm Tall wall W300 x D290 x H900mm	5397007163285	£24	A1	F1
	400mm Tall wall W400 x D290 x H900mm	5397007163292	£26	N1	na
	500mm Tall wall W500 x D290 x H900mm	5397007163308	£30	B1	G1
	600mm Tall wall (also doubles as a corner) W600 x D290 x H900mm	5397007163315	£34	A1x2	F1x2
	800mm Tall wall W800 x D290 x H900mm	5397007163322	£44	N1x2	na
	1000mm Tall wall W1000 x D290 x H900mm	5397007163339	£45	B1 x2	G1x2
	625 x 625mm Corner tall wall internal W625 x D625 x H900mm	5397007163346	£70	A1 x2	F1x2
	625 x 625mm Corner tall wall internal curved W625 x D625 x H900mm	5397007163353	£82	Curved tall	N/A
	Curved external tall wall curved W300 x D290 x H900mm	5397007163360	£38	Curved tall	N/A

Tall wall colour matched cabinets				You will also need	
				For full height door, door pack	For Glazed door
	150mm Tall Wall White W300 x D290 x H900mm	5397007163377	£48		N/A
	150mm Tall Wall Ivory Classic W300 x D290 x H900mm	5397007163384	£48		N/A
	150mm Tall Wall Gloss White W300 x D290 x H900mm	5397007163391	£48		N/A
	150mm Tall Wall Gloss Cream W300 x D290 x H900mm	5397007163407	£48		N/A
	150mm Tall Wall Gloss Anthracite W300 x D290 x H900mm	5397007162486	£48		N/A

Bridging cabinets				You will also need	
				For full height door, door pack	For glazed door, door pack
	600mm Wall bridging ▲ W600 x D290 x H280mm *	3038550	£27	D	N/A
	1000mm Wall bridging ▲ Suitable for non-framed doors only W1000 x D290 x H360mm *	3594612	£32	Z	ZA

▲ Our Banbury, Bedford, Burgess Hill, Bognor Regis, Consett, Eastleigh, Fareham, Hedge End, Nursling, Poole, Portsmouth, Port Glasgow and Sydenham stores stock a wide range of products – all available to take away. The symbol is used throughout this Buying Guide to indicate the products that these stores stock. However these are subject to availability and ranges may vary by store.

Appliance cabinets



Prices include the top, shelves and base with feet. All fixtures (including doors, end panels, and handles) need to be bought separately

					You will also need	
Larder cabinet shelf pack					Door packs	End panels
	300mm Larder shelf pack ▲ W300 x D570 x H2070mm	White	3305027	Was £21 Now £19	V x 1	Colour-matched tall end panels
	600mm Larder shelf pack ▲ W600 x D570 x H2070mm	White	3166857	Was £22 Now £20	NF Larder or pull-out unit E x 1 F Larder cupboard E x 1 Pull out unit E2 x 2	Colour-matched tall end panels
	600mm Mid-height larder shelf pack ▲ W600 x D570 x H1430mm	White	3166871	£16	R x 1* or S x 1* & J x 1	Colour-matched mid-height panels

* Replacement end panels will not fit this product.

					You will also need	
Fridge freezer housing shelf pack					Door packs	End panels
	600mm 50/50 Fridge freezer shelf pack ▲ W600 x D570 x H2070mm	White	3166956	£31	NF E x 1 F E2 x 2	Colour-matched tall end panels
	600mm 60/40 or 70/30† Fridge freezer shelf pack ▲ W600 x D570 x H2070mm	White	3166956	£31	NF U & R F U & I22	Colour-matched tall end panels

† For a 70/30 fridge freezer you need to raise the appliance by using one of the shelves supplied.

					You will also need	
Oven housing shelf packs					Door packs	End panels
	600mm Tall shelf pack for single oven ▲ W600 x D570 x H2070mm	White	3166956	£31	R x 1* or S x 1* J x 1 & H x 1**	Colour-matched tall end panels
	600mm Tall shelf pack for single oven with microwave ▲ W600 x D570 x H2070mm	White	3166956	£31	D x 1, H x 1** & J x 1	Colour-matched tall end panels
	600mm Tall shelf pack for double oven ▲ W600 x D570 x H2070mm	White	3166956	£31	J x 1, K x 1 & H x 1**	Colour-matched tall end panels
	600mm Tall shelf pack for double oven with microwave ▲ W600 x D570 x H2070mm	White	3166956	£31	Varies according to size of microwave (see page 5)	Colour-matched tall end panels

* Use pack R for a full height door or S if a drawer is required.

** When placing one appliance above another you may wish to use oven filler pack H in between.

Oven heat deflector kits

Oven heat deflectors that fit our oven housings. Protects kitchen doors from heat emitted by ovens

Single oven ▲ – to fit tall housing with 600mm aperture (not for built-under units)	3821350	£18
Double oven ▲ – to fit tall housing with 900mm aperture	3821374	£18
Built-under oven housing ▲	3821800	£18

Open cabinets



These open cabinets are made from colour-matched melamine and are designed to create display features or to soften the look of cabinet ends.

		Base or wall 150mm Wine rack † W150 x D290 x H720mm	300mm Open wall* W300 x D290 x H720mm	500mm Open wall** W500 x D290 x H720mm
Walnut Style Modern	▲	3434499	3680117	3434512
Maple Style Modern	▲	3279892	3680094	3279793
Cherry Style Modern	▲	3279878	3680087	3279786
Oak Style Slab		3313299	3680100	3313251
Traditional Oak Style	▲	3514399	3680124	3514382
Ivory Classic Style	▲	3279847	3680070	3279755
White Classic Style	▲	3233405	3680056	3168912
White Country Style	▲	3233405	3680056	3168912
Beech Style	▲	3233429	3680063	3168790
Gloss Cream Slab*	▲	3593561	3680148	3593554
Gloss White Slab*	▲	3279861	3680131	3279779
Gloss Black Slab*		-	3680056*	3168912*
Santini Gloss Grey* C&L	▲	5397007128017	-	-
Santini Gloss Anthracite* C&L	▲	5397007127744	-	-
Oak Style Shaker	▲	3313299	3680100	3313251
Walnut Style Shaker		3434499	3680117	3434512
Contemporary Maple Style		3279892	3680094	3279793
Gloss White Style	▲	3279861	3680131	3279779
Marletti Oak style Integrated Handle* C&L	▲	5397007128178	-	-
Marletti Gloss White Integrated Handle* C&L	▲	3279861	3680131	3279779
Classic Chestnut Style	▲	3594216	3823569	3594209
High gloss cream C&L	▲	-	-	-
High gloss black C&L	▲	-	-	-
High gloss white C&L	▲	-	-	-
Solid Oak C&L	▲	3279830	3823538	3279748
Solid Oak Classic C&L		3279830	3823538	3279748
Oak style framed		3870167	3870181	3870198
Ivory style framed	▲	3870105	3870129	3870136
Cream Style Classic		3870068	3869369	3869376
Clevedon C&L	▲	3878507	3878521	3878538
Carisbrooke Ivory C&L		-	-	-
Carisbrooke Taupe C&L		-	-	-
		£40	£25	£30

Drawer boxes & Hinges



These drawer boxes have been especially designed to fit the IT Kitchen ranges. Prices include the drawer box and fittings.

F Framed doors The framed range has a stylish additional outer frame into which sits the door.

NF Non-framed doors The non-framed range features doors that sit directly on your cabinetry.

Soft close mechanism has 100% full extension opening

Drawer boxes		Standard		Soft close	
Drawers	Compatibility	Standard	Price	Prestige soft close drawers	Price
To fit Non Framed Doors and standard doors	To Fit 300mm Base Cabinet ▲	3817032	Was £13 Now £12	3438152	£32
	To Fit 400mm Base Cabinet ▲	3817049	Was £14 Now £13	3438169	£33
	To Fit 500mm Base Cabinet ▲	3817056	Was £15 Now £14	3438176	£34
	To Fit 600mm Base Cabinet ▲	3817063	Was £16 Now £15	3438183	£35
Pan 3 drawer box pk	To Fit 500mm Base Cabinet - 2 Drawer Pack	5397007140989	£45	5397007141009	£85
	To complete the 3 drawer pack you also need	3817056	£15	3438176	£34
	To Fit 600mm Base Cabinet - 2 Drawer Pack	5397007140996	£55	5397007141016	£95
	To complete the 3 drawer pack you also need	3817063	£16	3438183	£35
	To Fit 800mm base cabinet - 3 Drawer Pack ▲	3090527	£53	3438190	£120
To Fit 1000mm base cabinet - 2 Drawer Pack ▲	-	-	3622902	£130	
Soft Close drawer upgrade	For use with standard drawer boxes ▲	3818626	£5	-	-
Built under oven housing drawer unit - To fit 600mm built under housing	For use with pack H ▲	3231739	£16	-	-
To fit Framed Doors	To Fit 300mm Base Cabinet ▲	-	-	3882429	£37
	To Fit 400mm* Base Cabinet ▲	-	-	3882436	£38
	To Fit 500mm** Base Cabinet ▲	-	-	3882443	£39
	To Fit 600mm Base Cabinet ▲	-	-	3882450	£40
	To Fit 800mm base cabinet - 3 Drawer Pack ▲	-	-	3882467	£125

Hinges (integrated soft close hinges)

Hinges	Description	EAN	Pack type	Price
To fit Non Framed doors and standard doors	Standard cabinet doors - Soft Close Upgrade † ▲	5397007016406	Pack ASC	£7
	Standard cabinet doors - Push to Open upgrade † ▲	3687420	Pack A+	£9
To fit Framed doors	Framed door hinge ▲	3882399	Pack ITA	£6
	Framed 625/925 corner door hinge ▲	3882405	Pack ITB	£11
	L shaped corner cabinet non framed 16-19mm doors ▲	5397007016468	Pack P	£16
	L shaped corner cabinet framed clevedon doors ▲	3458624	Pack B	£13
	L shaped corner cabinet framed 16-19mm doors ▲	3896907	Pack ITD	£19
	Framed bridging door hinge ▲	3882412	Pack C	£6

Any door used on a pull out unit will not require hinges and only some integrated appliances require hinges.







































Please check your appliance details carefully before ordering hinges for appliances doors.

† Please note push to open will not work on drawer boxes and curved or corner doors. If you want to include these in a push to open kitchen please use integrated strip handles. If you want to include these in a push to open kitchen please use integrated strip handles.

Colour co-ordinated end panels



All colour co-ordinated end panels and accessories featured on these pages are colour-matched melamine. Replacement wall end panels are compatible with all wall cabinets except the 600mm wall corner unit and bridging units. Replacement base end panels are compatible with all base cabinets except the 150mm pull-out unit or the 800mm pan drawer unit. The full height base end panel is compatible with all base units.

To co-ordinate with:																					
		Replacement wall end panel* W290 x D16 x H720mm x 1	Full height base end support panel* W570 x D16 x H870mm x 1	Replacement base end panel* W570 x D16 x H720mm x 1	Tall housing end panels† W570 x D16 x H1920mm x 2	Clad on wall panel**** W385 x D18 x H790mm	Clad on base panel W620 x D18 x H890mm	Clad On Tall housing panels W591 x D18 x H2100mm	Chunky Clad on wall panel W720 x D35 x H307mm	Chunky Clad on base panel W586 x D35 x H870mm	Chunky Clad On Tall housing panels W586 x D35 x H2070mm										
Walnut Style Modern	 ▲	3434420	£14	3434444	£16	3434437	£16	3434451	£50	4064664	£18	4064657	£22	4064671	£30	-	-	-			
Maple Style Modern	 ▲	3258545	£14	3258514	£16	3258538	£16	3258507	£50	4064695	£18	4064688	£22	4064701	£30	-	-	-			
Cherry Style Modern	 ▲	3188248	£14	3188156	£16	3188132	£16	3188255	£50	4064725	£18	4064718	£22	4064732	£30	-	-	-			
Oak Style Slab		3296202	£10	3296332	£16	3296301	£12	3296325	£32	4064633	£18	4064626	£22	4064640	£30	-	-	-			
Traditional Oak Style	 ▲	3514337	£18	3514290	£25	3514313	£20	3514283	£54	4064756	£19	4064749	£29	4064763	£40	-	-	-			
Ivory Classic Style	 ▲	3082409	£16	3166833	£25	3082157	£18	3166918	£52	4064817	£19	4064800	£29	4064824	£40	-	-	-			
White Classic Style	 ▲	-		3166840	£25	-		3166925	£52	4065173	£19	4065166	£29	4065180	£40	-	-	-			
White Country Style	 ▲	-		3166840	£25	-		3166925	£52	4065173	£19	4065166	£29	4065180	£40	-	-	-			
Beech Style	 ▲	3039458	£18	3166543	£25	3039465	£20	3166901	£54	4064787	£19	4064770	£29	4064794	£40	-	-	-			
Gloss Cream Slab*	 ▲	3593509	£16	3593462	£33	3593493	£33	3593455	£70	539700127782*	£27	539700127799*	£38	539700127805*	£45	539700140965	£30	539700140968	£45	539700140997	£65
Gloss White Slab*	 ▲	3640678	£16	3640692	£29	3640685	£20	3641002	£52	539700123760*	£27	539700123777*	£38	539700123784*	£45	539700140934	£30	539700140927	£45	539700140941	£65
Gloss Black Slab*	 ▲	3824221	£16	3824245	£29	3824238	£20	3824269	£52	539700127812*	£27	539700127829*	£38	539700127836*	£45	-	-	-	-	-	-
Santini Gloss Grey*	 ▲	539700122763	£16	539700122787	£29	539700122770	£20	539700122794	£52	539700122800*	£27	539700122817*	£38	539700122824*	£45	-	-	-	-	-	-
Santini Gloss Anthracite*	 ▲	539700123418	£16	539700123425	£29	539700123432	£20	539700123449	£52	539700123456*	£27	539700123463*	£38	539700123470*	£45	-	-	-	-	-	-
Oak Style Shaker	 ▲	3296202	£10	3296332	£16	3296301	£12	3296325	£32	4064633	£18	4064626	£22	4064640	£30	-	-	-	-	-	-
Walnut Style Shaker		3434420	£14	3434444	£16	3434437	£16	3434451	£50	4064664	£18	4064657	£22	4064671	£30	-	-	-	-	-	-
Contemporary Maple Style	 ▲	3258545	£14	3258514	£16	3258538	£16	3258507	£50	4064695	£18	4064688	£22	4064701	£30	-	-	-	-	-	-
Gloss White Style	 ▲	3640678	£18	3640692	£29	3640685	£20	3641002	£52	-	-	-	-	-	-	-	-	-	-	-	-
Marletti Oak style Integrated Handle*	 ▲	539700130386	£22	539700130409	£33	539700130393	£33	539700130416	£70	539700123111*	£27	539700123128*	£27	539700123135*	£45	-	-	-	-	-	-
Marletti Gloss White Integrated Handle*	 ▲	3640678	£18	3640692	£29	3640685	£20	3641002	£52	539700123760*	£27	539700123777*	£38	539700123784*	£45	539700140934	£30	539700140927	£45	539700140941	£65
Classic Chestnut Style	 ▲	3594155	£15	3594124	£24	3594148	£24	3594117	£55	4065289	£27	4065272	£33	4065296	£45	-	-	-	-	-	-
High gloss cream C&L	 ▲	3593509	£22	3593462	£33	3593493	£33	3593455	£70	539700127782	£27	539700127799	£39	539700127805	£45	-	-	-	-	-	-
High gloss black C&L	 ▲	3824221	£18	3824245	£29	3824238	£20	3824269	£52	539700127812	£27	539700127829	£38	539700127836	£45	-	-	-	-	-	-
High gloss white C&L	 ▲	3640678	£22	3640692	£33	3640685	£33	3641002	£70	539700123760	£27	539700123777	£38	539700123784	£45	-	-	-	-	-	-
Solid Oak C&L	 ▲	3082140	£17	3166550	£39	3082102	£39	3166635	£83	4064848	£29	4064831	£42	4064855	£50	-	-	-	-	-	-
Solid Oak Classic C&L		3082140	£17	3166550	£39	3082102	£39	3166635	£83	4064848	£29	4064831	£42	4064855	£50	-	-	-	-	-	-
Oak style framed		3871683	£28	3871706	£45	3871690	£45	3871720	£120	4065401	£35	4065395	£52	4065418	£70	-	-	-	-	-	-
Ivory style framed	 ▲	3871287	£28	3871300	£45	3871294	£45	3871324	£120	4065364	£35	4065357	£52	4065371	£70	-	-	-	-	-	-
Cream Style Classic		3870761	£28	3878774	£45	3870778	£45	3870808	£120	4065326	£35	4065319	£52	4065333	£70	-	-	-	-	-	-
Cream Style Classic T&G clad-on panel	 ▲	3878781	£28	-		3878798	£42	3878804	£94	-	-	-	-	-	-	-	-	-	-	-	-
Clevedon C&L	 ▲	3878248	£18	3878262	£35	3878255	£35	3878286	£75	3338605	£44	3338636	£76	3338643	£150	-	-	-	-	-	-
Carisbrooke Ivory C&L	 ▲	-		-		-		3166925	£58	3803226	£45	3803240	£78	3803257	£154	-	-	-	-	-	-
Carisbrooke Taupe C&L	 ▲	-		-		-		3166925	£58	3873410	£44	3873441	£78	3873458	£154	-	-	-	-	-	-

Clad-on kits

Wall clad-on kit ▲	W310 x D60 x H820mm x2 with curved front edge	Ivory classic style	3277928	£75
Base clad-on kit ▲	W595 x D60 x H900mm x2 with curved front edge	Ivory classic style	3277911	£85
Tall clad-on kit ▲	W590 x D18 x H2150mm x1 with squared front edge	Ivory classic style	3432204	£110

* Clad on panels for these ranges are oversized in height and depth and will need to be trimmed to fit. This is so that they can be scribed to the wall and floor if required. It also means the cornice and pelmet can be butted against them to achieve a very modern look and to stop the need to mitre the cornice or pelmet. They are supplied with a reversible front edge; one with a curved radius and one with a square edged radius.

** To create glass unit you will need door pack G

NEW LOWER PRICE

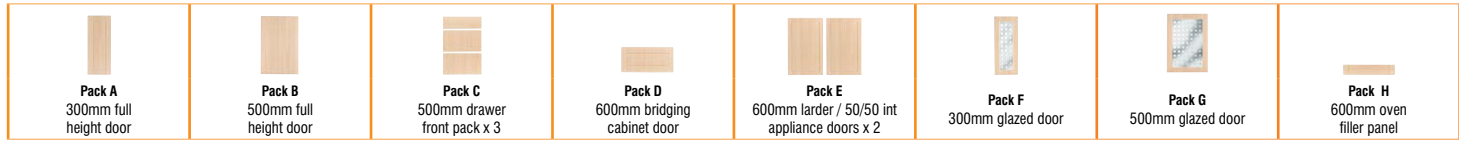

NF Non-framed	W297 x H715mm	W497 x H715mm	W497 x H156mm x 1 W497 x H277mm x 2	W597 x H277mm	W597 x H956mm x 2	W297 x H715mm	W497 x H715mm	W597 x H115mm
Walnut Style Modern	3620762 £16	3622117 £18	3622148 £24	3622230 £22	3622179 £38	3620786 £45	3622131 £50	3622223 £10
Maple Style Modern	3259412 £16	3259467 £18	3259498 £24	3259580 £22	3259528 £38	3259436 £45	3259481 £50	3259573 £10
Cherry Style Modern	3259726 £16	3259771 £18	3259801 £24	3259894 £22	3259832 £38	3259740 £45	3259795 £50	3259887 £10
Oak Style Slab	3823705 £16 £12*	3823712 £18 £18*	3823729 £24 £16*	3823736 £22 £16*	3823743 £38 £30*	3823750 £45	3823767 £50	3823774 £10 £8*
Traditional Oak Style	3510148 £20	3510155 £25	3510162 £27	3510179 £26	3510186 £45	3510193 £46	3510209 £51	3510216 £12
Ivory Classic Style	3278628 £18	3278666 £23	3278642 £25	3278659 £24	3278680 £42	3278635 £46	3278673 £51	3278697 £10
White Classic Style	5397007124187 £18	5397007124194 £23	5397007124200 £25	5397007124217 £24	5397007124224 £42	5397007124231 £46	5397007124248 £51	5397007124255 £10
White Country Style	3159040 £18	3159118 £23	3159125 £25	3159132 £24	3158746 £42	3158654 £46	3158685 £51	3158692 £10
Beech Style	3038833 £20	3038840 £25	3038918 £27	3038895 £26	3083048 £45	3038871 £46	3038888 £51	3038857 £12
Gloss Cream Slab	3593134 £23 £19*	3593141 £29 £24*	3593158 £45 £30*	3593165 £29 £24*	3593172 £58 £44*	3593189 £47	3593196 £52	3593202 £12 £10*
Gloss White Slab	3430705 £23 £19*	3430804 £29 £24*	3430873 £45 £30*	3431030 £29 £24*	3430941 £58 £44*	3430743 £47	3430859 £52	3431023 £12 £10*
Gloss Black Slab	3823934 £23 £19*	3823941 £29 £24*	3823958 £45 £30*	3823965 £29 £24*	3823972 £58 £44*	3823989 £47	3823996 £52	3824009 £12 £10*
Santini Gloss Grey	5397007122343 £23 £19*	5397007122350 £29 £24*	5397007122367 £45 £30*	5397007122374 £29 £24*	5397007122389 £58 £44*	5397007122596 £47	5397007122602 £52	5397007122619 £12 £10*
Santini Gloss Anthracite	5397007123197 £23 £19*	5397007123203 £29 £24*	5397007123210 £45 £30*	5397007123227 £29 £24*	5397007123234 £58 £44*	5397007123241 £47	5397007123258 £52	5397007123265 £12 £10*
Oak Style Shaker	3297759 £27 £20*	3297766 £30 £22*	3297773 £45 £25*	3297780 £30 £22*	3297797 £58 £36*	3298107 £49	3298114 £54	3298138 £14 £10*
Walnut Style Shaker	3433362 £27 £20*	3433379 £30 £22*	3433386 £45 £25*	3433393 £30 £22*	3433409 £58 £36*	3433416 £49	3433423 £54	3433430 £14 £10*
Contemporary Maple Style	3433669 £27 £20*	3433676 £30 £22*	3433683 £45 £25*	3433690 £30 £22*	3433805 £58 £36*	3433812 £49	3433829 £54	3433836 £14 £10*
Gloss White Style	3038727 £28	3038734 £34	3038796 £46	3038772 £33	3082881 £59	3038758 £50	3038765 £55	3038741 £14
Marletti Oak style Integrated Handle	5397007122893 £35	5397007122909 £39	5397007122916 £48	5397007122923 £38	5397007122930 £60	5397007122947 £51	5397007122954 £56	5397007122961 £20
Marletti Gloss White Integrated Handle	5397007123548 £35	5397007123555 £39	5397007123562 £48	5397007123579 £38	5397007123586 £60	5397007123593 £51	5397007123609 £56	3431023 £20
Classic Chestnut Style	3592830 £35	3592847 £39	3592854 £48	3592861 £38	3592878 £60	3592885 £51	3592892 £56	3592908 £20
High Gloss Cream C&L	3675939 £42 £39*	3675946 £50 £46*	3675953 £58	3675960 £42 £39*	3675977 £100 £80*	3675984 £57 £52*	3675991 £70 £64*	3676004 £30 £26*
High Gloss Black C&L	3526453 £42 £39*	3526460 £50 £46*	3526477 £58	3526484 £42 £39*	3526491 £100 £80*	3594759 £57 £52*	3594766 £70 £64*	3526507 £30 £26*
High Gloss White C&L	3676547 £42 £39*	3676554 £50 £46*	3676561 £58	3676578 £42 £39*	3676585 £100 £80*	3676592 £57 £52*	3676608 £70 £64*	3676615 £30 £26*
Solid Oak C&L	3097793 £54 £39*	3097786 £64 £46*	3097762 £76 £58*	3097779 £57 £39*	3097755 £120 £80*	3097748 £75 £52*	3097724 £85 £64*	3097731 £35 £26*
Solid Oak Classic C&L	3298060 £54 £39*	3298077 £64 £46*	3298084 £76 £58*	3298091 £57 £39*	3298305 £120 £80*	3298312 £75 £52*	3298329 £85 £64*	3298336 £35 £26*
Carisbrooke Ivory C&L	5397007124798 £60	5397007124804 £68	5397007124811 £75	5397007124828 £62	5397007124835 £105	5397007124842 £75	5397007124859 £89	5397007124866 £44
Carisbrooke Taupe C&L	5397007125177 £60	5397007125184 £68	5397007125191 £75	5397007125207 £62	5397007125214 £105	5397007125221 £75	5397007125238 £89	5397007125245 £44

F Framed	W300 x H720mm	W500 x H720mm	W500 x H720mm	W600 x H280mm	W600 x H960mm x 2	W300 x H720mm	W500 x H720mm	W600 x H115mm
Framed oak style**	3871331 £57	3871348 £64	3871362 £79	3871379 £42	3871393 £109	3871423 £79	3871430 £87	3871447 £34
Framed ivory style**	3870815 £57	3870822 £64	3870846 £79	3870853 £42	3870877 £109	3871003 £79	3871010 £87	3871027 £34
Framed classic cream**	3870310 £57	3870327 £64	3870341 £79	3870358 £57	3870372 £109	3870402 £79	3870419 £87	3870426 £34
Clevedon**	3338223 £75 £60*	3338230 £85 £68*	3338247 £90 £75*	3338254 £75 £62*	3338261 £200 £105*	3338278 £93 £75*	3338285 £103 £89*	3338292 £40 £44*

Hinge pack	ITA x 1	ITA x 1	-	ITC x 1	ITA x 2	ITA x 1	ITA x 1	-
------------	---------	---------	---	---------	---------	---------	---------	---

NEW LOWER PRICE

 Pack I 600mm integrated appliance door	 Pack J 600mm oven housing door	 Pack K 600mm Belfast sink door	 Pack L 150mm full height door	 Pack M 300mm drawerline door and drawer front	 Pack N 400mm full height door	 Pack N + 450mm Slimline Integrated dishwasher door	 Pack P 400mm drawerline door and drawer front	 Pack Q 500mm drawerline door and drawer front
---	---	---	--	--	--	---	--	--

NF Non-framed	W597 x H715mm	W597 x H557mm	W597 x H453mm	W147 x H715mm	W297 x H156mm x 1 W297 x H557mm x 1	W397 x H715mm	W397 x H715mm	W397 x H156mm x 1 W497 x H557mm x 1	W497 x H156mm x 1 W497 x H557mm x 1
Walnut Style Modern	3622186 £23	3622209 £23	3622216 £22	3620755 £14	3620779 £19	3620793 £17	-	3622100 £21	3622124 £24
Maple Style Modern	3259535 £23	3259559 £23	3259566 £22	3259405 £14	3259429 £19	3259443 £17	-	3259450 £21	3259474 £24
Cherry Style Modern	3259849 £23	3259863 £23	3259870 £22	3259719 £14	3259733 £19	3259757 £17	-	3259764 £21	3259788 £24
Oak Style Slab	3823781 £23 £19*	3823798 £23 £19*	3823804 £22 £17*	3823811 £14 £11*	3823828 £19 £15*	3823835 £17 £15*	-	3823842 £21 £16*	3823859 £24 £21*
Traditional Oak Style	3510223 £26	3510230 £29	3510247 £25	3510254 £17	3510261 £22	3510278 £23	-	3510285 £25	3510292 £26
Ivory Classic Style	3278703 £24	3278710 £26	3278727 £23	3278734 £16	3278741 £21	3278758 £21	-	3278765 £23	3278772 £24
White Classic Style	5397007124262 £24	5397007124279 £26	5397007124286 £23	5397007124293 £16	5397007124309 £21	5397007124316 £21	-	5397007124323 £23	5397007124330 £24
White Country Style	3158715 £24	3158753 £26	3158784 £23	3158807 £16	3158821 £21	3159101 £21	-	3158814 £23	3158869 £24
Beech Style	3038932 £26	3038925 £29	3038949 £25	3083109 £17	3083178 £21	3083369 £23	-	3083147 £25	3083239 £26
Gloss Cream Slab	3593219 £36 £30*	3593226 £33 £27*	3593233 £31 £26*	3593240 £20 £17*	3593257 £26 £22*	3593264 £28 £23*	-	3593271 £31 £26*	3593288 £32 £26*
Gloss White Slab	3430965 £36 £30*	3431009 £33 £27*	3431016 £31 £26*	3430682 £20 £17*	3430729 £26 £22*	3430764 £28 £23*	-	3430781 £31 £26*	3430835 £32 £26*
Gloss Black Slab	3824016 £36 £30*	3824023 £33 £27*	3824030 £31 £26*	3824047 £20 £17*	3824054 £26 £22*	3824061 £28 £23*	-	3824078 £31 £26*	3824085 £32 £26*
Santini Gloss Grey	5397007122626 £36 £30*	5397007122633 £33 £27*	5397007122640 £31 £26*	5397007122657 £20 £17*	5397007122664 £26 £22*	5397007122671 £28 £23*	-	5397007122688 £31 £26*	5397007122695 £32 £26*
Santini Gloss Anthracite	5397007123272 £36 £30*	5397007123289 £33 £27*	5397007123296 £31 £26*	5397007123302 £20 £17*	5397007123319 £26 £22*	5397007123326 £28 £23*	-	5397007123333 £31 £26*	5397007123340 £32 £26*
Oak Style Shaker	3298145 £36 £26*	3298152 £36 £26*	3298226 £32 £23*	3298233 £22 £16*	3298240 £31 £23*	3298257 £29 £21*	-	3298264 £33 £24*	3298271 £34 £25*
Walnut Style Shaker	3433447 £36 £26*	3433454 £36 £26*	3433461 £32 £23*	3433478 £22 £16*	3433485 £31 £23*	3433492 £29 £21*	3689844 £36 £26*	3433508 £33 £24*	3433515 £34 £25*
Contemporary Maple Style	3433843 £36 £26*	3433850 £36 £26*	3433881 £32 £23*	3433898 £22 £16*	3433904 £31 £23*	3433911 £29 £21*	-	3433928 £33 £24*	3433935 £34 £25*
Gloss White Style	3038819 £39	3038802 £40	3038826 £34	3083017 £25	3083123 £32	3083253 £31	-	3083086 £36	3083192 £37
Marietti Oak style Integrated Handle	5397007122978 £41	5397007122985 £47	5397007122992 £40	5397007123005 £28	5397007123012 £37	5397007123029 £37	-	5397007123036 £39	5397007123043 £41
Marietti Gloss White Integrated Handle	5397007123623 £41	5397007123630 £47	5397007123647 £40	5397007123654 £28	5397007123661 £37	5397007123678 £37	-	5397007123685 £39	5397007123692 £41
Classic Chestnut Style	3592915 £41	3592922 £47	3592939 £40	3592946 £28	3592953 £37	3592960 £37	3689844 £36	3592977 £39	3592984 £41
High Gloss Cream C&L	3676011 £57 £52*	3676028 £50 £46*	3676035 £47 £43*	3676042 £27 £25*	3676059 £47 £43*	3676066 £47 £43*	-	3676073 £50 £46*	3676080 £52 £52*
High Gloss Black C&L	3526514 £57 £52*	3526521 £50 £46*	3526538 £47 £43*	3526545 £27 £25*	3594773 £47 £43*	3526552 £47 £43*	-	3594780 £50 £46*	3594797 £52 £52*
High Gloss White C&L	3676707 £57 £52*	3676714 £50 £46*	3676721 £47 £43*	3676738 £27 £25*	3676745 £47 £43*	3676752 £47 £43*	-	3676769 £50 £46*	3676776 £52 £52*
Solid Oak C&L	3097717 £70 £52*	3097700 £68 £46*	3097694 £63 £43*	3097687 £42 £25*	3097670 £62 £43*	3097663 £62 £43*	-	3097618 £66 £46*	3097625 £67 £52*
Solid Oak Classic C&L	3298343 £70 £52*	3298350 £68 £46*	3298367 £63 £43*	3298374 £42 £25*	3298381 £62 £43*	3298398 £62 £43*	-	3298404 £66 £46*	3298411 £67 £52*
Carisbrooke Ivory C&L	5397007124873 £74	5397007124880 £72	5397007124887 £67	5397007124903 £46	5397007124910 £67	5397007124927 £65	-	5397007124934 £69	5397007124941 £74
Carisbrooke Taupe C&L	5397007125252 £74	5397007125269 £72	5397007125276 £67	5397007125283 £46	5397007125290 £67	5397007125306 £65	-	5397007125313 £69	5397007125320 £74

F Framed	-	W600 x H562mm	W600 x H562mm	W147 x H718mm	W300 x H720mm	W400 x H720mm	-	W400 x H720mm	W500 x H720mm
Framed oak style**	-	3871478 £64	3871492 £57	3871515 £38	3871522 £57	3871539 £57	-	3871546 £60	3871553 £64
Framed ivory style**	-	3871058 £64	3871072 £57	3871096 £38	3871102 £57	3871119 £57	-	3871126 £60	3871133 £64
Framed classic cream**	-	3870457 £64	3870471 £57	3870495 £38	3870600 £57	3870617 £57	-	3870624 £60	3870631 £64
Clevedon**	-	3338315 £85 £72*	3338322 £80 £67*	3338339 £45 £46*	3338346 £80 £67*	3338353 £80 £65*	-	3338360 £85 £69*	3338377 £90 £74*
Hinge pack	-	ITA x 1	-	-	-	-	-	-	-

NEW LOWER PRICE



NF Non-framed	W597 x H715mm	W597 x H156mm x 1 W597 x H557mm x 1	W797 X H156mm x 1 W797 x H277mm x 2	W597 x H1197mm	W297 x H956mm x 2	W597 x H156mm x1 W597 x H277mm x2	W997 x H356mm	W997 x H356mm
Walnut Style Modern	3622155 £22	3622162 £26	3622247 £29	3622193 £32	3622254 £31	-	-	-
Maple Style Modern	3259504 £22	3259511 £26	3259597 £29	3259542 £32	3305041 £31	-	-	-
Cherry Style Modern	3259818 £22	3259825 £26	3259900 £29	3259856 £32	3305034 £31	-	-	-
Oak Style Slab	3823866 £22 £17*	3823873 £26 £21*	3823880 £29 £23*	3823897 £32 £25*	3823903 £31 £25*	-	-	-
Traditional Oak Style	3510308 £26	3510315 £29	3510322 £32	3510339 £35	3510346 £34	-	-	-
Ivory Classic Style	3278789 £24	3278796 £27	3278802 £30	3278819 £32	3305072 £31	5397007140562 £31	-	-
White Classic Style	5397007124347 £24	5397007124354 £27	5397007124361 £30	5397007124378 £32	5397007124385 £31	5397007140569 £31	-	-
White Country Style	3159002 £24	3159019 £27	3159026 £30	3159033 £32	3304891 £31	-	-	-
Beech Style	3083413 £26	3083314 £29	3083475 £32	3083512 £35	3304860 £34	5397007140576 £34	-	-
Gloss Cream Slab	3593295 £33 £27*	3593301 £36 £30*	3593318 £49 £41*	3593325 £55 £46*	3593332 £50 £41*	5397007141108 £50 £41*	3593349 £36 £30*	3593356 £52 £43*
Gloss White Slab	3430880 £33 £27*	3430910 £36 £30*	3431047 £49 £41*	3430989 £55 £46*	3431054 £50 £41*	5397007141092 £50 £41*	3606032 £36 £30*	3606056 £52 £43*
Gloss Black Slab	3824092 £33 £27*	3824108 £36 £30*	3824115 £49 £41*	3824122 £55 £46*	3824139 £50 £41*	-	3824146 £36 £30*	3824153 £52 £43*
Santini Gloss Grey	5397007122701 £33 £27*	5397007122718 £36 £30*	5397007122725 £49 £41*	5397007122732 £55 £46*	5397007122749 £50 £41*	5397007141122 £50 £41*	5397007122756 £36 £30*	-
Santini Gloss Anthracite	5397007123357 £33 £27*	5397007123364 £36 £30*	5397007123371 £49 £41*	5397007123388 £55 £46*	5397007123395 £50 £41*	5397007141115 £50 £41*	5397007123401 £36 £30*	-
Oak Style Shaker	3296288 £34 £25*	3296295 £39 £29*	3298206 £50 £37*	3298213 £56 £41*	3305300 £52 £34*	-	-	-
Walnut Style Shaker	3433522 £34 £25*	3433539 £39 £29*	3433546 £50 £37*	3433553 £56 £41*	3433560 £52 £34*	3689868 £60 £44*	-	-
Contemporary Maple Style	3433942 £34 £25*	3433959 £39 £29*	3433966 £50 £37*	3433973 £56 £41*	3433980 £52 £34*	-	-	-
Gloss White Style	3083307 £39	3083215 £42	3083321 £52	3083376 £57	3304853 £54	5397007140583 £52	-	-
Marletti Oak style Integrated Handle	5397007123050 £41	5397007123067 £45	5397007123074 £54	5397007123081 £58	5397007123098 £55	-	5397007123104 £60	-
Marletti Gloss White Integrated Handle	5397007123708 £41	5397007123715 £45	5397007123722 £54	5397007123739 £58	5397007123746 £55	-	5397007123753 £60	-
Classic Chestnut Style	3592991 £41	3593004 £45	3593011 £54	3593028 £58	3593035 £55	3689912 £60	-	-
High Gloss Cream C&L	3676097 £55 £51*	3676103 £60 £55*	3676110 £67 £62*	3676127 £67 £62*	3676141 £75 £69*	3676172 £60	3676493 £45 £41*	3676509 £65 £60*
High Gloss Black C&L	3526569 £55 £51*	3594803 £60 £55*	3526576 £67 £62*	3526583 £67 £62*	3526590 £75 £69*	3689707 £60	3700235 £45 £41*	3700242 £65 £60*
High Gloss White C&L	3676783 £55 £51*	3676790 £60 £55*	3676806 £67 £62*	3676813 £67 £62*	3676837 £75 £69*	3676868 £60	3677162 £45 £41*	3677179 £65 £60*
Solid Oak C&L	3097632 £70 £51*	3097649 £76 £55*	3097656 £84 £62*	3097601 £90 £62*	3305232 £84 £69*	3694763 £60	-	-
Solid Oak Classic C&L	3298428 £70 £51*	3298435 £76 £55*	3298442 £84 £62*	3298459 £90 £62*	3305096 £84 £69*	3694824 £60	-	-
Carisbrooke Ivory C&L	5397007124958 £72	5397007124965 £76	5397007124972 £85	5397007124989 £86	5397007124996 £95	5397007125023 £82	-	-
Carisbrooke Taupe C&L	5397007125337 £72	5397007125344 £76	5397007125351 £85	5397007125368 £86	5397007125375 £95	5397007125405 £82	-	-

F Framed	W600 x H720mm	W600 x H720mm	W800 x H720mm	W597 x H1197mm	W300 x H960mm x 2	-	W997 x H356mm	W997 x H356mm
Framed oak style**	3871560 £68	3871577 £70	3871584 £94	3871591 £94	3871607 £87	-	-	-
Framed ivory style**	3871140 £68	3871157 £70	3871164 £94	3871171 £94	3871195 £87	-	-	-
Framed classic cream**	3870648 £68	3870655 £70	3870662 £94	3870679 £94	3870686 £87	-	-	-
Clevedon**	3338384 £95 £72*	3338391 £95 £76*	3338407 £100 £85*	3338414 £95 £86*	3338421 £130 £95*	3338452 £100 £82*	-	-
Hinge pack	-	-	-	Supplied with cabinet	ITA x 2	-	-	-

▲ Our Banbury, Bedford, Burgess Hill, Bognor Regis, Consett, Eastleigh, Fareham, Hedge End, Nursling, Poole, Portsmouth, Port Glasgow and Sydenham stores stock a wide range of products – all available to take away. The symbol is used throughout this Buying Guide to indicate the products that these stores stock. However these are subject to availability and ranges may vary by store.

NEW LOWER PRICE



NF Non-framed	W268.5 x H715mm	W335 x H720mm	W357 x H720mm	W357 x H720mm x 2	290 x 290 x 715mm	290 x 567 x 715mm	373 x 373 x 715mm	353 x 353 x 715mm	910 x 2100 x 18mm
Walnut Style Modern	4064466 £23	-	4064473 £25	4064480 £34	-	-	-	-	-
Maple Style Modern	4064404 £23	-	4064411 £25	4064428 £34	-	-	-	-	-
Cherry Style Modern	4064435 £23	-	4064442 £25	4064459 £34	-	-	-	-	-
Oak Style Slab	4064497 £23	-	4064602 £25	4064619 £34	-	-	-	-	-
Traditional Oak Style	4064206 £26	-	4064213 £32	4064220 £42	-	-	-	-	-
Ivory Classic Style	4064176 £26	-	4064183 £32	4064190 £42	5397007124477 £100	04159506 £120	5397007124576 £90	5397007124620 £110	-
White Classic Style	5397007124408 £26	-	5397007124392 £32	5397007124415 £42	5397007124484 £100	04159513 £120	5397007124583 £90	5397007124637 £110	-
White Country Style	4064145 £26	-	4064152 £32	4064169 £42	-	-	-	-	-
Beech Style	4064114 £26	-	4064121 £32	4064138 £42	-	-	-	-	-
Gloss Cream Slab	4064336 £28	-	4064343 £36	4064350 £46	5397007124453 £100	04159520 £120	5397007124552 £90	5397007124606 £110	5397007141146 £129
Gloss White Slab	4064305 £28	-	4064312 £36	4064329 £46	5397007124446 £100	04159537 £120	5397007124545 £90	5397007124590 £110	5397007141139 £129
Gloss Black Slab	4064367 £28	-	4064374 £36	4064381 £46	-	-	-	-	-
Santini Gloss Grey	5397007127980 £28	-	5397007127997 £36	5397007128000 £46	5397007124460 £100	04159544 £120	5397007124569 £90	5397007124613 £110	-
Santini Gloss Anthracite	5397007127713 £28	-	5397007127720 £36	5397007127737 £46	-	-	-	-	-
Oak Style Shaker	4064534 £30	-	4064541 £40	4064558 £50	-	-	-	-	-
Walnut Style Shaker	4064596 £30	-	4064909 £40	4064916 £50	-	-	-	-	-
Contemporary Maple Style	-	-	-	-	-	-	-	-	-
Gloss White Style	4064237 £35	-	4064244 £42	4064251 £54	-	-	-	-	-
Marletti Oak style Integrated Handle	4187516 £40	-	4187837 £50	4187844 £60	-	-	-	-	-
Marletti Gloss White Integrated Handle	4187509 £40	-	4187820 £50	4187905 £60	-	-	-	-	-
Classic Chestnut Style	4064565 £40	-	4064572 £50	4064589 £60	-	-	-	-	-
High Gloss Cream C&L	3676462 £72 £66*	-	3676486 £85 £78*	3895603 £100 £92*	-	-	-	-	-
High Gloss Black C&L	3813324 £72 £66*	-	3813348 £85 £78*	3895627 £100 £92*	-	-	-	-	-
High Gloss White C&L	3677131 £72 £66*	-	3677155 £85 £78*	3895580 £100 £92*	-	-	-	-	-
Solid Oak C&L	3825761 £88 £66*	-	3826058 £100 £78*	3892381 £119 £92*	-	-	-	-	-
Solid Oak Classic C&L	3825778 £88 £66*	-	3826065 £100 £78*	3892398 £119 £92*	-	-	-	-	-
Carisbrooke Ivory C&L	5397007163902 £90 £82*	-	5397007125085 £102 £94*	5397007125092 £119 £108*	-	-	-	-	-
Carisbrooke Taupe C&L	5397007163919 £90 £82*	-	5397007125467 £102 £94*	5397007125474 £119 £108*	-	-	-	-	-

F Framed	W335 x H720mm	W357 x H720mm	W357 x H720mm	W357 x H720mm x 2	-	-	-	-	-
Framed oak style**	4102809 £117	3871386 £117	3871416 £112	3899427 (LH) £112 3899489 (RH) £112	-	-	-	-	-
Framed ivory style**	4102823 £117	3870860 £117	3870891 £112	3899410 (LH) £112 3899472 (RH) £112	-	-	-	-	-
Framed classic cream**	4102816 £117	3870365 £117	3870396 £112	3899403 (LH) £112 3899465 (RH) £112	-	-	-	-	-
Clevedon**	3466261 £115	3878576 £115	3466285 £150	-	-	-	-	-	-
Hinge pack	ITD x 1 ITB x 1 (Clevedon)	ITD x 1 ITB x 1 (Clevedon)	ITD x 1 ITB x 1 (Clevedon)	P x 1 B x 1 (Clevedon)	-	-	-	-	-



F Framed	W497 x H715mm	W597 x H956mm	W596 x H717mm	W597 x H715mm	W597 x H557mm	W597 x H453mm
Framed oak style**	3871355 £60	3871409 £123	3871454 £67	3871461 £67	3871485 £65	3871508 £60
Framed ivory style** ▲	3870839 £60	3870884 £123	3871034 £67	3871041 £67	3871065 £65	3871089 £60
Framed classic cream**	3870334 £60	3870389 £123	3870433 £67	3870440 £67	3870464 £65	3870488 £60
Clevedon** ▲	3878569 £85	3878583 £130	3878590 £85	3878705 £85	3878712 £80	3878729 £70
Hinge pack ▲	-	Supplied with cabinet	-	Supplied with cabinet	-	-

Additional installation services

Need it fitting?
We can do it...

We are the most experienced national retailer in the UK today having completed over half a million individual projects!



Hard Flooring**

All types wooden, engineered and laminate flooring

fit from
£18
per sq.m.
Subject to survey

Carpet & Vinyl

All carpets and vinyl

fit from
£6
per sq.m.
Subject to survey

Tiling†

All types of wall and floor tiles

fit from
£39
per sq.m.
Subject to survey

Plumbing & Heating†

All systems general plumbing and replacement

fit from
£149
per sq.m.
Subject to survey

Radiators & Heated Towel Rails

fit from
£1649
Subject to survey

Boilers*

Electrics*

General wiring, circuits, lighting and appliance installations

fit from
£69
Subject to survey

Lock Replacement

Any lock, any door (internal/external), safes

fit from
£39
Subject to survey

Tap Replacement

Bathroom, kitchen, utility, ensuite and outside

fit from
£49
Subject to survey

Alarm Replacement

fit from
£99
Subject to survey

For a B&Q Homefit approved tradesman call:

01236 634557

Lines open: **Mon-Fri: 08.30-20.00**

Sat: 09.00-17.00 Sun: 10.00-16.00



Terms apply ***Electrics:** additional sockets installed from £69, doesn't include RCD protection. Installed within 500mm of an existing socket (which is part of a ring main). Surface mounted. Subject to survey • **Consumer units** installed from £519. 10 way board max. Fault finding not included. Same location. Doesn't include any alteration to existing supply or circuits. Subject to survey. †**Taps and Plumbing:** Taps fitted from £49. Includes all kitchen and bathroom taps on a like for like basis. Excluding exterior taps. Tap installation service provided by Streamline. ▼**Boiler installation** Boilers installed from £1649. Same location and system. Doesn't include upgrading the gas supply or any electrical upgrading • **Radiators** installed from £149. Like for like / same location and size. An additional drain down charge may apply. System Powerflush not included. ♦**Tiling:** from only £39 per sq/m. Includes tiling and adhesive. Excludes tiles, preparation, grout and accessories. ****Flooring:** Laminate flooring installed from £18 per sq/m, engineered flooring installed from £23 per sq/m, solid wood flooring installed from £35 per sq/m, installation of carpet from £5 per sq/m and installation of vinyl from £6 per sq/m. All flooring includes installation of underlay, flooring and beading (not skirting) only. Excludes flooring product. **Ask in store for all terms and conditions.**



NF Non-framed	W300xD220xH895mm	W400xD220xH895mm	W500xD220xH895mm	W600xD220xH895mm	W300xD220xH895mm	W500xD220xH895mm	W600xD220xH956/1136mm	W300xD220xH956/1136mm	W268xD220xH895mm
Santini Anthracite	5397007162493 £28	5397007162509 £34	5397007162516 £35	5397007162523 £40	5397007162530 £56	5397007162547 £62	5397007162554 £69	5397007162561 £60	5397007162578 £34
Gloss White Slab	5397007162707 £28	5397007162714 £34	5397007162721 £35	5397007162738 £40	5397007162745 £56	5397007162752 £62	5397007162769 £69	5397007162776 £60	5397007162783 £34
Gloss Cream Slab	5397007162882 £28	5397007162899 £34	5397007162905 £35	5397007162912 £40	5397007162929 £56	5397007162936 £62	5397007162943 £69	5397007162950 £60	5397007162967 £34
Ivory classic style	5397007163629 £26	5397007163636 £31	5397007163643 £34	5397007163650 £35	5397007163667 £55	5397007163674 £61	5397007163681 £64	5397007163688 £46	5397007163704 £32
White classic style	5397007163766 £26	5397007163773 £31	5397007163780 £34	5397007163797 £35	5397007163803 £55	5397007163810 £61	5397007163827 £64	5397007163834 £46	5397007163841 £32



NF Non-framed	W600xD220xH895mm	W600xD220xH895mm	W600xD220xH1377mm	W353xD353xH895mm	W353xD353xH895mm	W393xD220xH715mm	W353xD353xH715mm	W290xD567xH715mm
Santini Anthracite	5397007162585 £40	5397007162592 £37	5397007162608 £65	5397007162620 £132	5397007163551 £120	5397007163506 £90	5397007163513 £110	4187165 £120
Gloss White Slab	5397007162790 £40	5397007162806 £37	5397007162813 £65	5397007163582 £132	5397007163599 £120	-	-	-
Gloss Cream Slab	5397007162974 £40	5397007162981 £37	5397007162998 £65	5397007163605 £132	5397007163612 £120	-	-	-
Ivory classic style	5397007163711 £38	5397007163728 £34	5397007163735 £47	5397007163742 £132	5397007163759 £120	-	-	-
White classic style	5397007163858 £38	5397007163865 £34	5397007163872 £47	5397007163889 £132	5397007163896 £120	-	-	-



NF Non-framed	W32xD52xH895mm	W32xD52xH895mm	W359xD22xH937mm	W594xD22xH2280mm	W359xD22xH937mm	W570xD16xH2250mm	-	-	-
Santini Anthracite	5397007162622 £18	5397007162639 £19	5397007162646 £32	5397007162653 £55	5397007162660 £26	5397007162677 £84	5397007162691 £50	5397007163568 £30	5397007163575 £30
Gloss White Slab	5397007162820 £18	5397007162837 £19	5397007162844 £32	5397007162851 £54	5397007162868 £26	5397007162875 £84	-	-	-
Gloss Cream Slab	5397007163001 £18	5397007163018 £19	5397007163025 £32	5397007163032 £54	5397007163049 £26	5397007163056 £84	-	-	-
Ivory classic style	5397007163063 £18	5397007163070 £19	5397007163087 £23	5397007163094 £48	5397007163414 £19	5397007163483 £70	-	-	-
White classic style	5397007163100 £18	5397007163117 £19	5397007163124 £23	5397007163131 £48	-	5397007163490	-	-	-

Cornices, pelmets & corner posts



Colour co-ordinated cornice, pelmets & corner posts featured on this page are colour-matched melamine. To complete the look of your dream kitchen you may choose to add a cornice to the top of your wall cabinets and a pelmet to the bottom of you wall cabinets (our cornice/pelmet can be used on both). You may also want to consider hiding the legs of your cabinets with a plinth around the bottom of your kitchen.

To co-ordinate with:	Straight Cornice L2400mm	Straight Cornice/pelmet L2400mm †	Straight Pelmet L2400mm	Straight Plinth L2400mm x H150 x D16	Curved External Cornice/Pelmet	Curved Internal Cornice/Pelmet	Curved Internal/external reversible Plinth	Standard base corner post W57 x D57 x H720mm	Standard wall corner post W37 x D37 x H720mm	Cornice post for 925mm corner base cabinet W52 x D52 x H715mm	Cornice post for 625mm corner wall cabinet W32 x D32 x H715mm	Iron-on edging tape 21mm wide roll length 10 metres												
Walnut Style Modern	3433621	£16	3433614	£16	--	3434413	£14	--	--	3433572	£18	3433584	£16	3433607	£15	3434475	£7							
Maple Style modern	--	--	3259672	£16	--	3258552	£14	--	--	3259665	£18	3259658	£16	3259634	£15	3259641	£15	3192603	£7					
Cherry Style Modern	--	--	3259368	£16	--	3317402	£14	--	--	3259351	£18	3259344	£16	3259320	£15	3259337	£15	3192610	£7					
Oak Style Slab	3298268	£12	3298275	£12	--	3680155	£9	--	--	3298251	£18	3298244	£16	3298220	£15	3298237	£15	3166802	£7					
Traditional Oak Style	3510353	£23	--	3510360	£23	3514344	£22	--	--	3510377	£9	3510384	£16	3510391	£15	3510407	£15	3514351	£7					
Ivory Classic Style	3314548	£21	3278826	£30	3314708	£21	3436585	£18	5397007124521	£30	5397007124675	£30	5397007127911	£50	3314609	£18	3314616	£16	3314524	£15	3314531	£15	3279922	£7
White Classic Style	5397007123614	£21	5397007123807	£26	5397007123791	£21	3440407	£18	5397007124538	£30	5397007124682	£30	5397007127904	£50	3168165	£18	3168141	£16	3167786	£15	3167465	£15	--	
White Country Style	3167793	£21	--	3167588	£21	3440407	£18	--	--	3168165	£18	3168141	£16	3167786	£15	3167465	£15	--	--					
Beech Style	3039397	£23	--	3039403	£23	3514412	£22	--	--	3087657	£18	3087923	£16	3167540	£15	3167533	£15	3166628	£7					
Gloss Cream Slab	--	--	3593387	£22	--	3593516	£29	5397007124507	£30	5397007124651	£30	5397007127898	£50	3593394	£18	3593400	£16	3593370	£15	3593363	£15	3593523	£7	
Gloss White Slab	3431061	£22	3431078	£22	--	3641026	£20	5397007124491	£30	5397007124644	£30	5397007127881	£50	3431092	£18	3431115	£16	3431139	£15	3431153	£15	3279939	£7	
Gloss Black Slab	--	--	3824207	£22	--	3824214	£20	--	--	3824177	£18	3824160	£16	3824191	£15	3824184	£15	3593943	£7					
Santini Gloss Grey	--	--	5397007122679	£22	--	5397007122886	£20	5397007124514	£30	5397007124668	£30	5397007127874	£50	5397007122831	£18	5397007122848	£16	5397007122855	£15	5397007122862	£15	5397007128062	£7	
Santini Gloss Anthracite	--	--	5397007123524	£22	--	5397007123531	£20	--	--	5397007123487	£18	5397007123494	£16	5397007123500	£15	5397007123517	£15	5397007128079	£7					
Oak Style Shaker	3298268	£12	3298275	£12	--	3680155	£14	--	--	3298251	£18	3298244	£16	3298220	£15	3298237	£15	3166802	£7					
Walnut Style Shaker	3433621	£16	--	3433614	£30	3434413	£14	--	--	3433577	£18	3433584	£16	3433591	£15	3433607	£15	3434475	£7					
Contemporary Maple Style	3434147	£30	--	3434130	£30	3258552	£14	--	--	3433997	£18	3434109	£16	3434116	£15	3434123	£15	3192603	£7					
Gloss White Style	3039359	£35	--	3039342	£35	3641026	£20	--	--	3087619	£18	3087909	£16	3167502	£15	3167663	£15	3279939	£7					
Marletti Oak style Integrated Handle	--	--	5397007123180	£35	--	5397007130423	£29	--	--	5397007123142	£18	5397007123159	£16	5397007123166	£15	5397007123173	£15	5397007128161	£7					
Marletti Gloss White Integrated Handle	3431061	£22	3431078	£22	--	3641026	£20	--	--	3431092	£18	3431115	£16	3431139	£15	3431153	£15	3279939	£7					
Classic Chestnut Style	3593127	£35	--	3593066	£35	3594162	£30	--	--	3593073	£18	3593080	£16	3593059	£15	3593042	£15	3594179	£7					
High gloss cream C&L	--	--	3676394	£58	--	3593516	£29	--	--	3676363	£18	4066613	£16	4063537	£15	4063544	£15	3593523	£7					
High gloss black C&L	--	--	3813379	£58	--	3824214	£20	--	--	3526606	£18	4066620	£16	4063551	£15	4063568	£15	3593943	£7					
High gloss white C&L	--	--	3677063	£58	--	3641026	£20	--	--	3677032	£18	4066606	£16	4063513	£15	4063520	£15	3279939	£7					
Solid Oak C&L	3107218	£35	--	3105269	£35	3514405	£30	--	--	3105030	£18	3105016	£16	3167762	£15	3167755	£15	3166802	£7					
Solid Oak Classic C&L	3298510	£35	--	3298527	£35	3514405	£30	--	--	3105030	£18	3105016	£16	3167762	£15	3167755	£15	3166802	£7					
Oak style framed	3871652	£35	--	3871669	£35	3871676	£30	--	--	3871621	£18	3871614	£16	Not required	Not required	3870143	£7							
Ivory style	3871256	£35	--	3871263	£35	3871270	£30	--	--	3871225	£18	3871218	£16	Not required	Not required	3869383	£7							
Clevedon C&L	3338650	£57	--	3338667	£57	3333808	£45	--	--	3361924	£18	--	Not required	Not required	3892152	£7								
Cream Style Classic	3870730	£35	--	3870747	£35	3870754	£30	--	--	3870709	£18	3870693	£16	Not required	Not required	3870044	£7							
Carisbrooke Ivory C&L	--	--	5397007125160	£35	--	3803271	£45	--	--	3802384	£18	5397007125146	£16	5397007125153	£15	5397007125139	£15	3821503	£10					
Carisbrooke Taupe C&L	--	--	5397007125542	£35	--	3873472	£45	--	--	3873489	£18	5397007125528	£16	5397007125535	£15	5397007125511	£15	3870204	£10					
Stainless Steel	--	--	--	--	5397007127867	£29	--	--	5397007127928	£19	--	--	--	--	--	--	--	--						

‡ Can be used as a cornice and pelmet for these kitchen styles. † L3000mm. * D18mm

Plinth and accessories

Plinth fixing strip	▲ 2.4mm	Clear plastic	5012176460033	£6
Rigid plinth seal	16mm		5060135377687	£6

▲ Our Banbury, Bedford, Burgess Hill, Bognor Regis, Consett, Eastleigh, Fareham, Hedge End, Nursing, Poole, Portsmouth, Port Glasgow and Sydenham stores stock a wide range of products – all available to take away. The symbol is used throughout this Buying Guide to indicate the products that these stores stock. However these are subject to availability and ranges may vary by store.

Spares and accessories

	Cabinet connector bolts ▲	Pack of 20	3232521	£3
	Cabinet cover caps ▲	Pack of 250	3153512	£4
	Door straps ▲	To join 2 doors together (e.g. to create a larger door) Pack of 2	3095553	£4
	Assembly spares pack ▲	4mm x 20mm x 10 screws, 4mm x 30mm x 10 screws, 4mm x 15mm x 10 screws, 4mm x 40mm x 10 screws, 2 x angle brackets, 8mm x 30mm x 4 wooden dowels, 2 x cams, 2 x cam pins	3232514	£2
	Plinth lock ▲	Pack of 6 (Removeable Locking system for Plinths)	3868751	£9
	Gloss door cleaner ▲		3868775	£9
	150mm Cabinet legs with plinth clips ▲	Pack of 2 legs + Pack 2 plinth clips	5397007058703	£2.50
	Plinth clips	Pack of 4 plastic plinth clips	5397007058697	£2.50
	Remo 1 bluetooth kitchen audio system	2 speakers x 5W 1 subwoofer x 10W 1 bluetooth connector	5397007141160	£99

Soft close door accessories for Non-Framed doors

	Self-adhesive door buffers ▲	Pack of 100	3153505	£4
	Kitchen gas door stay kit (for use with bridging units) 80N ▲	Metallic silver effect	3361269	£8
	Door hinges ▲	110 Degree (Pack of 2)	3043974	£4
		170 Degree (Pack of 2)	3232538	£5
	Premium soft close door buffer (for use on the internal corner of cabinet nearest the hinge, giving a longer soft closing action) ▲	Pack of 5	3361214	£8
	Premium door buffers (use with cabinets on the opposite side to the hinge) ▲	Pack of 5	3190005	£6.50
	Clip on soft close adapters (Clip onto hinges supplied with IT cabinets and hinge 3043974 (not suitable for 170 degree hinges))	Pack of 2 (2 per cabinet required)	5397007141023	£4.00
	Clip on door buffer	Pack of 5	5397007159080	£7

Decorative legs

	150mm Decorative legs ▲	Pack of 2 Chrome effect. With beech collar.	5055746	£14
	150mm Circular legs ▲	Pack of 4 Brushed nickel finish	3361139	£21
	150mm Plastic legs ▲	Pack of 4 Silver finish	5347612	£9

Base cabinets



Standard base cabinets					You will also need		
					For full height door, door pack*	For top drawer & door, door pack*	Drawer box if required**
	150mm Base cabinet Includes pull-out rack W150 x D570 x H870mm	Oak	5397007139501	£102 £40*	L x 1	n/a	n/a
		White	5397007138863	£102 £40*			
	300mm Base cabinet W300 x D570 x H870mm	Oak	5397007139518	£77 £38*	A x 1	M x 1	NF LOD1 x 1
		White	5397007138870	£77 £38*			F ID1 x 1
	400mm Base cabinet W400 x D570 x H870mm	Oak	5397007139525	£82 £40*	N x 1	P x 1	NF LOD2 x 1
		White	5397007138887	£82 £40*			F ID2 x 1
	450mm Base cabinet W450 x D570 x H870mm	Oak	5397007139532	£85 £42*	N+ x 1	P+ x 1	NF LOD450 x 1
		White	5397007138894	£85 £42*			F ID450 x 1
	500mm Base cabinet W500 x D570 x H870mm	Oak	5397007139549	£87 £44*	B x 1	Q x 1	NF LOD3 x 1
		White	5397007138900	£87 £44*			F ID3 x 1
	600mm Base cabinet W600 x D570 x H870mm	Oak	5397007139556	£90 £46*	R x 1	S x 1	NF LOD4 x 1
		White	5397007138917	£90 £46*			F ID4 x 1
	800mm Base cabinet W800 x D570 x H870mm	Oak	5397007139563	£92 £48*	N x 2	P x 2	NF LOD2 x 2
		White	5397007138924	£92 £48*			F ID2 x 2
	900mm Base cabinet W900 x D570 x H870mm	Oak	5397007139570	£97 £50*	N+ x 2	P+ x 2	NF LOD450 x 2
		White	5397007138931	£97 £50*			F ID450 x 2
	1000mm Base cabinet W1000 x D570 x H870mm	Oak	5397007139587	£102 £51*	B x 2	Q x 2	NF LOD3 x 2
		White	5397007138948	£102 £51*			F ID3 x 2

Heights include legs. These cabinets are colour-matched melamine.

Multi-drawer base cabinets					You will also need		
					For 3 drawer cabinet, door pack*	Drawer box if required**	
	500mm Multi-drawer base cabinet W500 x D570 x H870mm	Oak	5397007139594	£77 £42*	C x 1	NF LOD3 x 1 & LOD5 x 1	F ID3 x 1 & ID5 x 1
		White	5397007138955	£77 £42*			
	600mm Multi-drawer base cabinet W600 x D570 x H870mm	Oak	5397007139600	£82 £44*	Y x 1	NF LOD4 x 1 & LOD6 x 1	F ID4 x 1 & ID6 x 1
		White	5397007138962	£82 £44*			
	800mm Multi-drawer base cabinet W800 x D570 x H870mm	Oak	5397007139617	£87 £46*	T x 1	NF LOD7 x 1	F ID7 x 1
		White	5397007138979	£87 £46*			

Pan base cabinets					You will also need		
					For 2 drawer cabinet, door pack*	Drawer box if required**	
	1000mm Pan base cabinet W1000 x D570 x H870mm	Oak	5397007139624	£97 £50*	Z or ZA x 2 or Z x 1 & ZA x 1	LOD9 x 1	
		White	5397007138986	£97 £50*			
	1000mm Curved pan base cabinet W1000 x D570 x H870mm	White	5397007138986	£97 £50*	Curved pan drawer	Curved drawer box	

Corner base cabinets					You will also need		
					For full height door, door pack*	For top drawer & door, door pack*	Drawer box if required**
	800mm Corner base cabinet W800 x D570 x H870mm	Oak	5397007139563	£92 £48*	N x 1	P x 1	NF LOD2 x 1
		White	5397007138924	£92 £48*			F ID2 x 1
Base corner post x 1							
	925mm Corner base cabinet W925 x D925 x H870mm	Oak	5397007139648	£122 £64*	EE x 1	n/a	n/a
		White	5397007139006	£122 £64*			
	1000mm Corner base cabinet W1000 x D570 x H870mm	Oak	5397007139587	£102 £51*	B x 1	Q x 1	NF LOD3 x 1
		White	5397007138948	£102 £51*			F ID3 x 1
Base corner post x 1							

Curved base cabinets					You will also need		
					Door/drawer pack*		
	Curved external base cabinet W300 x D570 x H870mm	Oak	5397007139662	£87 £46*	Matching curved door & base filler panel		
		White	5397007139020	£87 £46*			
	Curved internal corner base cabinet W925 x D925 x H870mm	White	5397007139471	£128 £66*			CVBint

Open base cabinets					You will also need		
					Frame pack*		
	300mm Base open end cabinet W300 x D570 x H870mm	Oak	5397007139679	£70 £46*	OP1 x 1		
		White	5397007139037	£70 £46*			
	500mm Open base cabinet W500 x D570 x H870mm	Oak	5397007139549	£87 £44*	OP4 x 1		
		White	5397007138900	£87 £44*			

Other base cabinets					You will also need		
					For full height door, door pack*	For top drawer & door, door pack*	Drawer box if required**
	600mm Belfast sink cabinet W600 x D570 x H615mm	Oak	5397007139716	£77 £39*	H x 1	n/a	n/a
		White	5397007139075	£77 £39*			
	600mm Oven housing cabinet W600 x D570 x H870mm	Oak	5397007139709	£82 £39*	K x 1	n/a	n/a
		White	5397007139068	£82 £39*			

Built under oven housing heat deflector kits available



Wall cabinets



Standard wall cabinets				You will also need	
				Door pack*	
	300mm Wall cabinet W300 x D335 x H720mm	Oak	5397007139723	£72 £36*	A x 1 Carisbrooke AS x 1
		White	5397007139082	£72 £36*	
	400mm Wall cabinet W400 x D335 x H720mm	Oak	5397007139730	£77 £38*	N x 1 Carisbrooke NS x 1
		White	5397007139099	£77 £38*	
	450mm Wall cabinet W450 x D335 x H720mm	Oak	5397007139747	£79 £40*	N+ x 1 Carisbrooke NS+ x 1
		White	5397007139105	£79 £40*	
	500mm Wall cabinet W500 x D335 x H720mm	Oak	5397007139754	£82 £43*	B x 1 Carisbrooke BS x 1
		White	5397007139112	£82 £43*	
	600mm Wall cabinet W600 x D335 x H720mm	Oak	5397007139761	£87 £45*	R x 1 Carisbrooke RS x 1
		White	5397007139129	£87 £45*	
	800mm Wall cabinet W800 x D335 x H720mm	Oak	5397007139778	£92 £47*	N x 2 Carisbrooke NS x 2
		White	5397007139136	£92 £47*	
	900mm Wall cabinet W900 x D335 x H720mm	Oak	5397007139785	£95 £49*	N+ x 2 Carisbrooke NS+ x 2
		White	5397007139143	£95 £49*	
	1000mm Wall cabinet W1000 x D335 x H720mm	Oak	5397007139792	£97 £50*	B x 2 Carisbrooke BS x 2
		White	5397007139150	£97 £50*	

These cabinets are colour-matched melamine.

Tall wall cabinets				You will also need	
				Door pack*	
	300mm Tall wall cabinet W300 x D335 x H900mm	Oak	5397007139808	£77 £46*	A1 x 1 Carisbrooke AS1 x 1
		White	5397007139167	£77 £46*	
	400mm Tall wall cabinet W400 x D335 x H900mm	Oak	5397007139815	£82 £48*	N1 x 1 Carisbrooke NS1 x 1
		White	5397007139174	£82 £48*	
	450mm Tall wall cabinet W450 x D335 x H900mm	Oak	5397007139822	£85 £50*	N1+ x 1 Carisbrooke NS1+ x 1
		White	5397007139181	£85 £50*	
	500mm Tall wall cabinet W500 x D335 x H900mm	Oak	5397007139839	£87 £52*	B1 x 1 Carisbrooke BS1 x 1
		White	5397007139198	£87 £52*	
	600mm Tall wall cabinet W600 x D335 x H900mm	Oak	5397007139846	£92 £54*	R1 x 1 Carisbrooke RS1 x 1
		White	5397007139204	£92 £54*	
	800mm Tall wall cabinet W800 x D335 x H900mm	Oak	5397007139853	£97 £56*	N1 x 2 Carisbrooke NS1 x 2
		White	5397007139211	£97 £56*	
	900mm Tall wall cabinet W900 x D335 x H900mm	Oak	5397007139860	£100 £58*	N1+ x 2 Carisbrooke NS1+ x 2
		White	5397007139228	£100 £58*	
	1000mm Tall wall cabinet W1000 x D335 x H900mm	Oak	5397007139877	£102 £60*	B1 x 2 Carisbrooke BS1 x 2
		White	5397007139235	£102 £60*	

Curved end wall cabinets				You will also need	
				Door pack*	
	Curved external end wall cabinet W300 x D335 x H720mm	Oak	5397007139952	£77 £45*	NF Matching curved door & curved wall filler post F Curved door (wall curved door for Carisbrooke)
		White	5397007139310	£77 £45*	
	900mm Curved external tall wall curved cabinet W300 x D335 x H900mm	Oak	5397007139969	£65 £40*	NF Matching tall wall curved door & tall wall filler post F Tall wall curved door
		White	5397007139327	£65 £40*	

Corner wall cabinets				You will also need	
				Door pack*	
	625mm L shaped corner wall cabinet W625 x D625 x H720mm	Oak	5397007139884	£107 £62*	DD x 1 Carisbrooke DDS x 1
		White	5397007139242	£107 £62*	
	625mm L shaped tall corner wall cabinet W625 x D625 x H900mm	Oak	5397007139891	£112 £68*	DD1 x 1 Carisbrooke DDS1 x 1
		White	5397007139259	£112 £68*	
	625mm internal corner wall cabinet W625 x D625 x H720mm	White	5397007139488	£125 £70*	CVW INT
	625mm internal tall corner wall cabinet W625 x D625 x H900mm	White	5397007139495	£125 £70*	CVT INT

Wall bridging cabinets				You will also need	
				Door pack*	
	500mm Deep bridging cabinet W500 x D570 x H450mm	Oak	5397007139921	£72 £42*	AA x 1 Carisbrooke AAS x 1
		White	5397007139280	£72 £42*	
	600mm Wall bridging cabinet W600 x D335 x H280mm	Oak	5397007139938	£67 £40*	D x 1 Carisbrooke DS x 1
		White	5397007139297	£67 £40*	
	1000mm Wall bridging cabinet W1000 x D335 x H360mm	Oak	5397007139945	£102 £42*	Z or ZA x 1
		White	5397007139303	£102 £42*	

Step 1

Pick your Clic cabinets (excluding hinges)

**NEW
LOWER
PRICE**



**COOKE
& LEWIS**

Wall cabinets



Wine rack, plate rack & glass cabinets					You will also need	
					Door pack	
	150mm Wine rack Use for wall W150 x D335 x H720mm	Oak	5397007139976	£72 £42*	OP5 x 1 Carisbrooke: OP5 x 1* or OP5S x 1**	Solid oak classic, Oak veneer shaker
		White	5397007139334	£72 £42*		
	300mm Glass cabinet W300 x D335 x H720mm	Oak	5397007139723	£72 £36*	F x 1	Carisbrooke FS x 1
		White	5397007139082	£72 £36*		
	300mm Tall glass cabinet W300 x D335 x H900mm	Oak	5397007139808	£77 £46*	F1 x 1	Carisbrooke FS1 x 1
		White	5397007139167	£77 £46*		
	500mm Wall wine, plate or glass cabinet W500 x D335 x H720mm	Oak	5397007139754	£82 £43*	Wine rack OP4 x 1 & OP6 x 1 Plate rack OP4 x 1 & OP7 x 1	Glass door G x 1 (Carisbrooke GS x 1)
		White	5397007139112	£82 £43*		
	500mm Tall glass cabinet W500 x D335 x H900mm	Oak	5397007139839	£87 £52*	G1 x 1	Carisbrooke GS1 x 1
		White	5397007139198	£87 £52*		

Wall open end cabinets

Wall open end cabinets						You will also need	
						Frame pack	
	300mm Wall open end cabinet W300 x D335 x H720mm	Oak	5397007139983	£72 £42*	OP2 x 1		
		White	5397007139341	£72 £42*			
	300mm Tall wall open end cabinet W300 x D335 x H900mm	Oak	5397007140002	£77 £44*	OP3 x 1		
		White	5397007139365	£77 £44*			

Dresser cabinets

Dresser cabinets						You will also need	
						Door/ drawer pack*	Drawer box if required**
	500mm Dresser cabinet W500 x D335 x H1162mm	Oak	5397007140026	£92 £54*	W x 1	NF LOD8 x 1	E ID8 x 1
		White	5397007139389	£92 £54*			
	500mm Tall dresser cabinet W500 x D335 x H1342mm	Oak	5397007140033	£97 £56*	W1 x 1	NF LOD8 x 1	E ID8 x 1
		White	5397007139396	£97 £56*			

Larder cabinets



Standard larder cabinets

Standard larder cabinets							You will also need	
							Door/drawer pack	
	300mm Standard larder cabinet W300 x D570 x H2070mm	Oak	End panels	5397007140040	£97 £59*	V x 1		
			Shelf pack	5397007140057	£87 £47*			
		White	End panels	5397007139402	£89 £39*			
			Shelf pack	5397007139419	£89 £47*			
	600mm Standard larder cabinet W600 x D570 x H2070mm	Oak	End panels	5397007140040	£97 £59*	NF Larder cupboard or pull-out unit E x 1		
			Shelf pack	5397007140064	£77 £49*			
		White	End panels	5397007139402	£97 £59*			
			Shelf pack	5397007139426	£77 £49*			

Tall larder cabinets

Tall larder cabinets							You will also need	
							Door/drawer pack*	
	300mm Tall larder cabinet W300 x D570 x H2250mm	Oak	End panels	5397007140071	£102 £60*	V1 x 1		
			Shelf pack	5397007140057	£87 £47*			
		White	End panels	5397007139433	£102 £60*			
			Shelf pack	5397007139419	£87 £47*			
	600mm Tall larder cabinet W600 x D570 x H2250mm	Oak	End panels	5397007140071	£102 £60*	NF Larder cupboard or pull-out unit E1 x 1		
			Shelf pack	5397007140064	£77 £49*			
		White	End panels	5397007139433	£102 £60*			
			Shelf pack	5397007139426	£77 £49*			

These cabinets are colour-matched melamine. †† Wall only.

UNICLIC PATENTED TECHNOLOGY

UNICLIC PATENTED TECHNOLOGY

Appliance housings



Fridge freezer cabinets

				You will also need	
				Door & drawer pack*	
	Oak	End panels	5397007140088	£92 £58*	NF E x 1 F E2 x 2
		Shelf pack	5397007140095	£92 £58*	
	White	End panels	5397007139440	£92 £58*	
		Shelf pack	5397007139457	£92 £58*	
	Oak	End panels	5397007140088	£92 £58*	NF U x 1 & R x 1 F I22 x 1 & U x 1
		Shelf pack	5397007140095	£92 £58*	
	White	End panels	5397007139440	£92 £58*	
		Shelf pack	5397007139457	£92 £58*	
	Oak	End panels	5397007140101	£102 £60*	NF E1 x 1 (Solid oak classic: n/a) F E2 x 1 & E12 x 1
		Shelf pack	5397007140095	£92 £58*	
	White	End panels	5397007139464	£102 £60*	
		Shelf pack	5397007139457	£92 £58*	
	Oak	End panels	5397007140101	£102 £60*	NF R x 1 & U1 x 1 (Solid oak classic: n/a) F I22 x 1 & U1 x 1
		Shelf pack	5397007140095	£92 £58*	
	White	End panels	5397007139464	£102 £60*	
		Shelf pack	5397007139457	£92 £58*	

These cabinets are colour-matched melamine. Cabinet illustrations show positioning of unit doors. Doors and drawer fronts are not included and need to be purchased separately. * For doors and drawer fronts see pages 11–16.

Standard height oven cabinets

				You will also need	
				Door/drawer pack*	Drawer box if required
	Oak	End panels	5397007140088	£92 £58*	J x 1 & K x 1 n/a
		Shelf pack	5397007140095	£92 £58*	
	White	End panels	5397007139440	£92 £58*	
		Shelf pack	5397007139457	£92 £58*	
	Oak	End panels	5397007140088	£92 £58*	J x 1 & R x 1 n/a
		Shelf pack	5397007140095	£92 £58*	
	White	End panels	5397007139440	£92 £58*	
		Shelf pack	5397007139457	£92 £58*	
	Oak	End panels	5397007140088	£92 £58*	J x 1 & D x 1 n/a
		Shelf pack	5397007140095	£92 £58*	
	White	End panels	5397007139440	£92 £58*	
		Shelf pack	5397007139457	£92 £58*	
	Oak	End panels	5397007140088	£92 £58*	J x 1 & Y x 1 LOD4 x 1 & LOD6 x 1 F ID4 x 1 & ID6 x 1
		Shelf pack	5397007140095	£92 £58*	
	White	End panels	5397007139440	£92 £58*	
		Shelf pack	5397007139457	£92 £58*	
	Oak	End panels	5397007140088	£92 £58*	BB x 1 & K x 1 LOD6 x 1 F ID6 x 1
		Shelf pack	5397007140095	£92 £58*	
	White	End panels	5397007139440	£92 £58*	
		Shelf pack	5397007139457	£92 £58*	

Tall oven cabinets

				You will also need	
				Door/drawer pack*	Drawer box if required
	Oak	End panels	5397007140101	£102 £60*	J x 1 K1 x 1 & X x 1 n/a
		Shelf pack	5397007140095	£92 £58*	
	White	End panels	5397007139464	£102 £60*	
		Shelf pack	5397007139457	£92 £58*	
	Oak	End panels	5397007140101	£102 £60*	R x 1 J1 x 1 & X x 1 n/a
		Shelf pack	5397007140095	£92 £58*	
	White	End panels	5397007139464	£102 £60*	
		Shelf pack	5397007139457	£92 £58*	
	Oak	End panels	5397007140101	£102 £60*	Door packs to be selected based on the size of the microwave being used. Drawer box n/a
		Shelf pack	5397007140095	£92 £58*	
	White	End panels	5397007139464	£102 £60*	
		Shelf pack	5397007139457	£92 £58*	
	Oak	End panels	5397007140101	£102 £60*	Y x 1 & J1 x 1 LOD4 x 1 & LOD6 x 1 F ID4 x 1 & ID6 x 1
		Shelf pack	5397007140095	£92 £58*	
	White	End panels	5397007139464	£102 £60*	
		Shelf pack	5397007139457	£92 £58*	
	Oak	End panels	5397007140101	£102 £60*	BB x 1 & K1 x 1 LOD6 x 1 F ID6 x 1
		Shelf pack	5397007140095	£92 £58*	
	White	End panels	5397007139464	£102 £60*	
		Shelf pack	5397007139457	£92 £58*	

Oven heat deflector kits

Protects kitchen doors from heat emitted by ovens.

Single oven – to fit tall housing with 600mm aperture (not for built-under units)	3821367	£17
Double oven – to fit tall housing with 900mm aperture	3821381	£17
Built-under oven housing	3821817	£17

Base cabinets



Standard base cabinets				You will also need		
				For full height door, door pack*	For top drawer & door, door pack*	Drawer box if required**
	150mm Base cabinet ▲ Includes pull-out rack W150 x D570 x H870mm	Oak	3457177	£102 £40*	L x 1	n/a
		White	3679067	£102 £40*		
	300mm Base cabinet ▲ W300 x D570 x H870mm	Oak	3457078	£77 £38*	A x 1	M x 1 NF LOD1 x 1 F ID1 x 1
		White	3678947	£77 £38*		
	400mm Base cabinet ▲ W400 x D570 x H870mm	Oak	3457085	£82 £40*	N x 1	P x 1 NF LOD2 x 1 F ID2 x 1
		White	3678954	£82 £40*		
	450mm Base cabinet ▲ W450 x D570 x H870mm	Oak	3679517	£85 £42*	N+ x 1	P+ x 1 NF LOD450 x 1 F ID450 x 1
		White	3678961	£85 £42*		
	500mm Base cabinet ▲ W500 x D570 x H870mm	Oak	3457092	£87 £44*	B x 1	Q x 1 NF LOD3 x 1 F ID3 x 1
		White	3678978	£87 £44*		
	600mm Base cabinet ▲ W600 x D570 x H870mm	Oak	3457108	£90 £46*	R x 1	S x 1 NF LOD4 x 1 F ID4 x 1
		White	3678985	£90 £46*		
	800mm Base cabinet ▲ W800 x D570 x H870mm	Oak	3457115	£92 £48*	N x 2	P x 2 NF LOD2 x 2 F ID2 x 2
		White	3678992	£92 £48*		
	900mm Base cabinet ▲ W900 x D570 x H870mm	Oak	3679548	£97 £50*	N+ x 2	P+ x 2 NF LOD450 x 1 F ID450 x 2
		White	3679005	£97 £50*		
	1000mm Base cabinet ▲ W1000 x D570 x H870mm	Oak	3457122	£102 £51*	B x 2	Q x 2 NF LOD3 x 2 F ID3 x 2
		White	3679012	£102 £51*		
	600mm Belfast sink cabinet ▲ W600 x D570 x H615mm	Oak	3457191	£82 £39*	K x 1	n/a
		White	3679098	£82 £39*		
	600mm Oven housing cabinet ▲ W600 x D570 x H870mm	Oak	3457207	£77 £39*	H x 1	n/a
		White	3679104	£77 £39*		

Heights include legs. These cabinets are colour-matched melamine. Built under oven housing heat deflector kits available

Multi-drawer base cabinets

Multi-drawer base cabinets				You will also need		
				For 3 drawer cabinet, door pack*	Drawer box if required**	
	500mm Multi-drawer base cabinet ▲ W500 x D570 x H870mm	Oak	3457146	£77 £42*	C x 1	NF LOD3 x 1 & LOD5 x 1 F ID3 x 1 & ID5 x 1
		White	3679036	£77 £42*		
	600mm Multi-drawer base cabinet ▲ W600 x D570 x H870mm	Oak	3457153	£82 £44*	Y x 1	NF LOD4 x 1 & LOD6 x 1 F ID4 x 1 & ID6 x 1
		White	3679043	£82 £44*		
	800mm Multi-drawer base cabinet ▲ W800 x D570 x H870mm	Oak	3457160	£87 £46*	T x 1	NF LOD7 x 1 F ID7 x 1
		White	3679050	£87 £46*		
	1000mm base cabinet ▲ W1000 x D570 x H870mm	Oak	3886250	£97 £50*	Z or ZA x 2 or Z x 1 & ZA x 1	LOD9 x 1
		White	3679470	£97 £50*		
	1000mm Curved base cabinet ▲ W1000 x D570 x H870mm	White	3679470	£97 £50*	Curved pan drawer	Curved drawer box

Corner base cabinets

Corner base cabinets				You will also need		
				For full height door, door pack*	For top drawer & door, door pack*	Drawer box if required**
	800mm Corner base cabinet ▲ W800 x D570 x H870mm	Oak	3457115	£92 £48*	N x 1	P x 1 NF LOD2 x 1 F ID2 x 1
		White	3678992	£92 £48*		
Base corner post x 1						
	925mm Corner base cabinet ▲ W925 x D925 x H870mm	Oak	3457139	£122 £64*	EE x 1	n/a
		White	3679029	£122 £64*	EEDL x 1	
	1000mm Corner base cabinet ▲ W1000 x D570 x H870mm	Oak	3457122	£102 £51*	B x 1	Q x 1 NF LOD3 x 1 F ID3 x 1
		White	3679012	£102 £51*		
Base corner post x 1						
	Curved internal 925mm corner base cabinet ▲ W925 x D925 x H870mm	White	5397007128246	£128 £66*	CVBint	

Curved base cabinets

Curved base cabinets				You will also need	
				Door/drawer pack*	
	Curved external base cabinet ▲ W300 x D570 x H870mm	Oak	3680025	£87 £46*	Matching curved door & base filler panel
		White	3679500	£87 £46*	

Open base cabinets

Open base cabinets				You will also need	
				Frame pack*	
	300mm Base open end cabinet ▲ W300 x D570 x H870mm	Oak	3457184	£70 £46*	OP1 x 1
		White	3679074	£70 £46*	
	500mm Open base cabinet ▲ W500 x D570 x H870mm	Oak	3457092	£87 £44*	OP4 x 1
		White	3678978	£87 £44*	

Wall cabinets



Standard wall cabinets (Comes complete with 2 shelves)				You will also need	
				Door pack*	
	300mm Wall cabinet ▲ W300 x D335 x H720mm	Oak	3457214	£72 £36*	A x 1 Carisbrooke AS x 1
		White	3679111	£72 £36*	
	400mm Wall cabinet ▲ W400 x D335 x H720mm	Oak	3457221	£77 £38*	N x 1 Carisbrooke NS x 1
		White	3679128	£77 £38*	
	450mm Wall cabinet ▲ W450 x D335 x H720mm	Oak	3679692	£79 £40*	N+ x 1 Carisbrooke NS+ x 1
		White	3679135	£79 £40*	
	500mm Wall cabinet ▲ W500 x D335 x H720mm	Oak	3457238	£82 £43*	B x 1 Carisbrooke BS x 1
		White	3679142	£82 £43*	
	600mm Wall cabinet ▲ W600 x D335 x H720mm	Oak	3457245	£87 £45*	R x 1 Carisbrooke RS x 1
		White	3679159	£87 £45*	
	800mm Wall cabinet ▲ W800 x D335 x H720mm	Oak	3457252	£92 £47*	N x 2 Carisbrooke NS x 2
		White	3679166	£92 £47*	
	900mm Wall cabinet ▲ W900 x D335 x H720mm	Oak	3679777	£95 £49*	N+ x 2 Carisbrooke NS+ x 2
		White	3679173	£95 £49*	
	1000mm Wall cabinet ▲ W1000 x D335 x H720mm	Oak	3457269	£97 £50*	B x 2 Carisbrooke BS x 2
		White	3679180	£97 £50*	

These cabinets are colour-matched melamine.
All wall units should be installed in their specified vertical position.

Tall wall cabinets (Comes complete with 3 shelves)				You will also need	
				Door pack*	
	300mm Tall wall cabinet ▲ W300 x D335 x H900mm	Oak	3457290	£77 £46*	A1 x 1 Carisbrooke AS1 x 1
		White	3679210	£77 £46*	
	400mm Tall wall cabinet ▲ W400 x D335 x H900mm	Oak	3457306	£82 £48*	N1 x 1 Carisbrooke NS1 x 1
		White	3679227	£82 £48*	
	450mm Tall wall cabinet ▲ W450 x D335 x H900mm	Oak	3679821	£85 £50*	N1+ x 1 Carisbrooke NS1+ x 1
		White	3679234	£85 £50*	
	500mm Tall wall cabinet ▲ W500 x D335 x H900mm	Oak	3457313	£87 £52*	B1 x 1 Carisbrooke BS1 x 1
		White	3679241	£87 £52*	
	600mm Tall wall cabinet ▲ W600 x D335 x H900mm	Oak	3457320	£92 £54*	R1 x 1 Carisbrooke RS1 x 1
		White	3679258	£92 £54*	
	800mm Tall wall cabinet ▲ W800 x D335 x H900mm	Oak	3457337	£97 £56*	N1 x 2 Carisbrooke NS1 x 2
		White	3679265	£97 £56*	
	900mm Tall wall cabinet ▲ W900 x D335 x H900mm	Oak	3679852	£100 £58*	N1+ x 2 Carisbrooke NS1+ x 2
		White	3679272	£100 £58*	
	1000mm Tall wall cabinet ▲ W1000 x D335 x H900mm	Oak	3457344	£102 £60*	B1 x 2 Carisbrooke BS1 x 2
		White	3679289	£102 £60*	

Curved end wall cabinets				You will also need	
				Door pack*	
	Curved external end wall cabinet ▲ W300 x D335 x H720mm	Oak	3680001	£77 £45*	NF Matching curved door & curved wall filler post
		White	3679494	£77 £45*	
	900mm Curved external tall wall cabinet ▲ W300 x D335 x H900mm	Oak	3878552	£65 £40*	NF Matching tall wall curved door & tall wall filler post
		White	3878545	£65 £40*	

Corner wall cabinets				You will also need	
				Door pack*	
	625mm L shaped corner wall cabinet ▲ W625 x D625 x H720mm	Oak	3457276	£107 £62*	DD x 1 Carisbrooke DDS x 1
		White	3679197	£107 £62*	
	625mm shaped tall corner wall cabinet ▲ W625 x D625 x H900mm	Oak	3457351	£112 £68*	DD1 x 1 Carisbrooke DDS1 x 1
		White	3679296	£112 £68*	
	625mm internal corner wall cabinet ▲ W625 x D625 x H720mm	White	5397007128239	£120 £70*	CVW INT
		White	5397007128222	£125 £70*	CVT INT

Wall bridging cabinets				You will also need	
				Door pack*	
	500mm Deep bridging cabinet ▲ W500 x D570 x H450mm	Oak	3457399	£72 £42*	AA x 1 Carisbrooke AAS x 1
		White	3679333	£72 £42*	
	600mm Wall bridging cabinet ▲ W600 x D335 x H280mm	Oak	3457382	£67 £40*	D x 1 Carisbrooke DS x 1
		White	3679326	£67 £40*	
	1000mm Wall bridging cabinet ▲ W1000 x D335 x H360mm	Oak	3886267	£102 £42*	Z or ZA x 1
		White	3679487	£102 £42*	

Wall cabinets



Wine rack, plate rack & glass cabinets

You will also need

Door pack

	150mm Wine rack ▲ Use for wall W150 x D335 x H720mm	Oak	3457375	£72 £42*	OP5 x 1 Carisbrooke: OP5 x 1* or OP5S x 1**
		White	3679319	£72 £42*	
	150mm Tall wine rack ▲ Use for wall W150 x D335 x H900mm	White	5397007128253	£82 £52*	OP51
		300mm Glass cabinet ▲ W300 x D335 x H720mm	Oak	3457214	£72 £36*
		White	3679111	£72 £36*	
	300mm Tall glass cabinet ▲ W300 x D335 x H900mm	Oak	3457290	£77 £46*	F1 x 1 Carisbrooke FS1 x 1
		White	3679210	£77 £46*	
	500mm Wall wine, plate or glass cabinet ▲ W500 x D335 x H720mm	Oak	3457238	£82 £43*	Wine rack OP4 x 1 & OP6 x 1 Plate rack OP4 x 1 & OP7 x 1
		White	3679142	£82 £43*	
	500mm Tall glass cabinet ▲ W500 x D335 x H900mm	Oak	3457313	£87 £52*	G1 x 1 Carisbrooke GS1 x 1
		White	3679241	£87 £52*	

Wall open end cabinets

You will also need

Frame pack

	300mm Wall open end cabinet ▲ W300 x D335 x H720mm	Oak	3457405	£72 £42*	OP2 x 1
		White	3679340	£72 £42*	
	300mm Tall wall open end cabinet ▲ W300 x D335 x H900mm	Oak	3457429	£77 £44*	OP3 x 1
		White	3679371	£77 £44*	

Dresser cabinets

You will also need

Door/
drawer
pack*

Drawer box
if required**

	500mm Dresser cabinet ▲ W500 x D335 x H1162mm	Oak	3457412	£92 £54*	W x 1 NF LOD8 x 1 F ID8 x 1
		White	3679364	£92 £54*	
	500mm Tall dresser cabinet ▲ W500 x D335 x H1342mm	Oak	3457436	£97 £56*	W1 x 1 NF LOD8 x 1 F ID8 x 1
		White	3679395	£97 £56*	

Larder cabinets



Standard larder cabinets

You will also need

Door/drawer pack

	300mm Standard larder cabinet ▲ W300 x D570 x H2070mm	Oak	End panels 3457443	£97 £59*	V x 1	
		White	Shelf pack 3457481	£77 £47*		
	600mm Standard larder cabinet ▲ W600 x D570 x H2070mm	Oak	End panels 3457443	£97 £59*		NF Larder cupboard or pull-out unit E x 1 F Larder cupboard E x 1 Pull-out unit E2 x 2
		White	Shelf pack 3457498	£87 £49*		
	300mm Tall larder cabinet ▲ W300 x D570 x H2250mm	Oak	End panels 3457467	£102 £60*	V1 x 1	
		White	Shelf pack 3457481	£77 £47*		
	600mm Tall larder cabinet ▲ W600 x D570 x H2250mm	Oak	End panels 3679425	£102 £60*		NF Larder cupboard or pull-out unit E1 x 1 F Larder cupboard E1 x 1 Pull-out unit E12 x 1 & E2 x 1
		White	Shelf pack 3679449	£77 £47*		

Tall larder cabinets

You will also need

Door/drawer pack*

	300mm Tall larder cabinet ▲ W300 x D570 x H2250mm	Oak	End panels 3457467	£102 £60*	V1 x 1	
		White	Shelf pack 3457481	£77 £47*		
	600mm Tall larder cabinet ▲ W600 x D570 x H2250mm	Oak	End panels 3679425	£102 £60*		NF Larder cupboard or pull-out unit E1 x 1 F Larder cupboard E1 x 1 Pull-out unit E12 x 1 & E2 x 1
		White	Shelf pack 3679449	£77 £47*		

These cabinets are colour-matched melamine. †† Wall only.

Appliance housings



Fridge freezer cabinets					You will also need	
					Door & drawer pack*	
	600mm Fridge freezer cabinet 50/50 ▲ W600 x D570 x H2070mm	Oak	End panels	3457443	£92 £59*	NF E x 1 F E2 x 2
		White	Shelf pack	3457504	£92 £58*	
	End panels		3458501	£92 £59*		
	Shelf pack	3679463	£92 £58*			
	600mm Fridge freezer cabinet 60/40 or 70/30 ▲ W600 x D570 x H2070mm	Oak	End panels	3457450	£92 £58*	NF U x 1 & R x 1 F I22 x 1 & U x 1
		White	Shelf pack	3457504	£92 £58*	
	End panels		3679418	£92 £58*		
	Shelf pack	3679463	£92 £58*			
	600mm Tall fridge freezer cabinet 50/50 ▲ W600 x D570 x H2250mm	Oak	End panels	3457467	£102 £60*	NF E1 x 1 (Solid oak classic: n/a) F E2 x 1 & E12 x 1
		White	Shelf pack	3457504	£92 £58*	
	End panels		3679425	£102 £60*		
	Shelf pack	3679463	£92 £58*			
	600mm Tall fridge freezer cabinet 60/40 or 70/30 ▲ W600 x D570 x H2250mm	Oak	End panels	3457474	£102 £60*	NF R x 1 & U1 x 1 (Solid oak classic: n/a) F I22 x 1 & U1 x 1
		White	Shelf pack	3457504	£92 £58*	
	End panels		3679432	£102 £60*		
	Shelf pack	3679463	£92 £58*			

Standard height oven cabinets					You will also need	
					Door/drawer pack*	Drawer box if required
	600mm Double oven cabinet (900mm apt) ▲ W600 x D570 x H2070mm	Oak	End panels	3457450	£92 £58*	J x 1 & K x 1
		White	Shelf pack	3457504	£92 £58*	
	End panels		3679418	£92 £58*		
	Shelf pack	3679463	£92 £58*			
	600mm Single oven cabinet (600mm apt) ▲ W600 x D570 x H2070mm	Oak	End panels	3457450	£92 £58*	J x 1 & R x 1
		White	Shelf pack	3457504	£92 £58*	
	End panels		3679418	£92 £58*		
	Shelf pack	3679463	£92 £58*			
	600mm Single oven & microwave cabinet (1000mm apt) ▲ W600 x D570 x H2070mm	Oak	End panels	3457450	£92 £58*	J x 1 & D x 1
		White	Shelf pack	3457504	£92 £58*	
	End panels		3679418	£92 £58*		
	Shelf pack	3679463	£92 £58*			
	600mm Single oven with 2 pan drawers & 1 standard drawer (600mm apt) ▲ W600 x D570 x H2070mm	Oak	End panels	3457450	£92 £58*	J x 1 & Y x 1
		White	Shelf pack	3457504	£92 £58*	
	End panels		3679418	£92 £58*		
	Shelf pack	3679463	£92 £58*			
	600mm Double oven with 2 pan drawers (900mm apt) ▲ W600 x D570 x H2070mm	Oak	End panels	3457450	£92 £58*	BB x 1 & K x 1
		White	Shelf pack	3457504	£92 £58*	
	End panels		3679418	£92 £58*		
	Shelf pack	3679463	£92 £58*			

Tall oven cabinets					You will also need	
					Door/drawer pack*	Drawer box if required
	600mm Tall double oven cabinet (900mm apt) ▲ W600 x D570 x H2250mm	Oak	End panels	3457474	£102 £60*	J x 1 & K1 x 1 & X x 1
		White	Shelf pack	3457504	£92 £58*	
	End panels		3679432	£102 £60*		
	Shelf pack	3679463	£92 £58*			
	600mm Tall single oven cabinet (600mm apt) ▲ W600 x D570 x H2250mm	Oak	End panels	3457474	£102 £60*	R x 1 & J1 x 1 & X x 1
		White	Shelf pack	3457504	£92 £58*	
	End panels		3679432	£102 £60*		
	Shelf pack	3679463	£92 £58*			
	600mm Tall Single oven & microwave cabinet (1000mm apt) ▲ W600 x D570 x H2250mm	Oak	End panels	3457474	£102 £60*	Door packs to be selected based on the size of the microwave being used. Drawer box n/a
		White	Shelf pack	3457504	£92 £58*	
	End panels		3679432	£102 £60*		
	Shelf pack	3679463	£92 £58*			
	600mm Tall single oven with 2 pan drawers & 1 standard drawer (600mm apt) ▲ W600 x D570 x H2250mm	Oak	End panels	3457474	£102 £60*	NF Y x 1 & J1 x 1
		White	Shelf pack	3457504	£92 £58*	
	End panels		3679432	£102 £60*		
	Shelf pack	3679463	£92 £58*			
	600mm Tall double oven with 2 pan drawers (900mm apt) ▲ W600 x D570 x H2250mm	Oak	End panels	3457474	£102 £60*	NF BB x 1 & K1 x 1
		White	Shelf pack	3457504	£92 £58*	
	End panels		3679432	£102 £60*		
	Shelf pack	3679463	£92 £58*			

These cabinets are colour-matched melamine. Cabinet illustrations show positioning of unit doors. Doors and drawer fronts are not included and need to be purchased separately. * For doors and drawer fronts see pages 11–16.

Oven heat deflector kits

Protects kitchen doors from heat emitted by ovens.

Single oven ▲ – to fit tall housing with 600mm aperture (not for built-under units)	3821367	£17
Double oven ▲ – to fit tall housing with 900mm aperture	3821381	£17
Built-under oven housing ▲	3821817	£17

Door hinges

**Hinge packs** these hinges are for use with the chillingham range, hinges come in pairs

Non-framed soft-close hinges			
Pack ASC ▲	Standard doors	5397007016406	£5
Pack A ▲	600mm bridging unit door **	3458617	£7
Pack B ▲	L shaped corner cabinet doors (22mm)**	3458624	£13
Pack C ▲	L shaped corner cabinet doors with corner post **	5397007016444	£10
Pack P ▲	L shaped corner cabinet doors(16-19mm) **	5397007016468	£16
Pack CSC ▲	Diagonal corner cabinet doors + curved internal cabinets	4004585	£10
Pack J ▲	1000mm bridging unit door not including stay	3698679*	£25

** Standard hinge & buffer

Non-framed push to open hinges †			
Pack A+ ▲	Standard cabinet doors	3687420	£9
Pack J+ ▲	1000mm bridging unit door inc stay	3698686*	£30

† Push to open doors will not work on drawer boxes, curved doors or corner doors. If you want to include these in a push to open kitchen please use integrated strip handles:

Framed soft-close hinges			
Pack DSC ▲	Standard doors (including non-framed curved)***	4004592	£11
Pack D ▲	600mm bridging unit door *	3458648	£10
Pack E ▲	L shaped corner cabinet doors (22mm) *	3458655	£16
Pack FSC ▲	Diagonal corner cabinet doors***	4004608	£13

*** Integrated soft close hinge *Standard hinge

Overlap hinges NB. Chillingham not compatible with soft close doors			
Pack L ▲	Standard doors	3882108	£11
Pack M ▲	L shaped doors	3882115	£16
Pack N ▲	Diagonal corner cabinet doors	3882122	£13

Other			
Pack G ▲	Fridge freezer doors	5397007016420	£7
Pack H ▲	600mm bridging unit stay pack	3460726	£10

Drawer boxes & accessories

These drawer boxes have been especially designed to fit the IT Kitchen ranges. Prices include the drawer box and fittings.

F Framed doors The framed range has a stylish additional outer frame into which sits the door.**NF Non-framed doors** The non-framed range features doors that sit directly on your cabinetry.

Drawers	Description	Depth	Non Framed			Framed		
			Pack	EAN	Price	Pack	EAN	Price
Drawer Boxes ▲	300mm Drawer Box	450mm	LOD1	3458686	£48	ID1	3458761	£48
	400mm Drawer Box	450mm	LOD2	3458693	£51	ID2	3458778	£51
	450mm Drawer Box	450mm	LOD450	3680162	£56	ID450	3680179	£56
	500mm Drawer Box	450mm	LOD3	3458709	£55	ID3	3458785	£55
	600mm Drawer Box	450mm	LOD4	3458716	£61	ID4	3458792	£61
Multi-drawer Boxes ▲	500mm Pan Drawer Boxes (pair)*	450mm	LOD5	3458723	£140	ID5	3458808	£140
	600mm Pan Drawer Boxes (pair)*	450mm	LOD6	3458730	£153	ID6	3458815	£153
	800mm Pan Drawer Boxes (set of 3)	450mm	LOD7	3458747	£199	ID7	3458822	£199
	1000mm Pan Drawer Boxes (pair)	450mm	LOD9	3594605	£174	-	-	-
Dresser Drawer boxes ▲	Dresser Drawer Boxes (set of 2)	270mm	LOD8	3458754	£69	ID8	3458839	£69
Curved Drawer Boxes ▲	1000mm Curved drawer boxes (set of 2)	450mm	-	3680186	£178	-	3680186	£178

* Need to purchase a single drawer to complete a multi drawer unit

Step 2

Pick your doors & drawer fronts (excluding hinges*)

**NEW
LOWER
PRICE**

**COOKE
& LEWIS**



NF Non-framed	W597 x H277mm	W268 x H715mm x 2	W268 x H895mm x 2	W597 x H956mm x 2	W597 x H956mm x 1 W597 x H1136mm x 1	W333 x H715mm x 2	W357 x H720mm x 2	W297 x H715mm	W297 x H895mm
High gloss walnut ▲	-	3878941 £72 £66*	3878958 £77 £69*	-	-	3878965 £85 £78*	-	3878972 £57 £52*	3878989 £62 £57*
High gloss white ▲	3676578 £42 £39*	3677131 £72 £66*	3677148 £77 £69*	3676585 £100 £80*	3676936 £105 £100*	3677155 £85 £78*	3895580 £100 £92*	3676592 £57 £52*	3676912 £62 £57*
High gloss cream ▲	3675960 £42 £39*	3676462 £72 £66*	3676479 £77 £69*	3675977 £100 £80*	3676257 £105 £100*	3676486 £85 £78*	3895603 £100 £92*	3675984 £57 £52*	3676233 £62 £57*
High gloss black ▲	3526484 £42 £39*	3813324 £72 £66*	3813331 £77 £69*	3526491 £100 £80*	3689585 £105 £100*	3813348 £85 £78*	3895627 £100 £92*	3594759 £57 £52*	3689592 £62 £57*
High gloss red ▲	3526231 £42 £39*	3813164 £72 £66*	3813171 £77 £69*	3526248 £100 £80*	3689172 £105 £100*	3813188 £85 £78*	3895634 £100 £92*	3593837 £57 £52*	3689189 £62 £57*
High gloss aubergine ▲	4022992 £42 £39*	3878408 £72 £66*	3878415 £77 £69*	4023807 £100 £80*	4023814 £105 £100*	3878422 £85 £78*	4023821 £100 £92*	3878439 £57 £52*	3878446 £62 £57*
Appleby cream ▲	3872062 £54 £53*	3872079 £82 £81*	3872086 £86 £85*	3872093 £110 £90*	3872109 £120 £118*	3872116 £92 £90*	3895658 £107 £105*	3872123 £70 £69*	3872130 £75 £74*
Appleby white ▲	4011828 £54 £53*	4011859 £82 £81*	4011880 £86 £85*	4011910 £110 £90*	4011934 £120 £118*	4011965 £92 £90*	4017011 £107 £105*	4011996 £70 £69*	4012023 £75 £74*
Farleigh	3874493 £62	3874509 £93	3874516 £99	3874523 £105	3874530 £130	3874547 £106	3894767 £123	3874554 £75	3874561 £86
Solid oak ▲	3097779 £57 £39*	3825761 £88 £66*	5397007163926 £92 £69*	3097755 £120 £80*	3694626 £121 £110*	3826058 £100 £78*	3892381 £119 £92*	3097748 £75 £52*	3694633 £79 £57*
Solid oak classic	3298091 £57 £39*	3825778 £88 £66*	3694848 £92 £69*	3298305 £120 £80*	-	3826065 £100 £78*	3892398 £119 £92*	3298312 £75 £52*	-
Carisbrooke Ivory ▲	5397007158786 £62	5397007163902 £93	5397007163933 £99	5397007124836 £105	5397007140231 £130	5397007125085 £106	5397007125092 £123	5397007124842 £75	5397007140248 £86
Carisbrooke Taupe ▲	5397007158793 £62	5397007163919 £93	5397007163940 £99	5397007125214 £105	5397007140408 £130	5397007125467 £106	5397007125474 £123	5397007125221 £75	5397007140415 £86
Hedingham	3509173 £62	3509739 £99 £93*	3509746 £121 £99*	3509203 £160 £105*	3509463 £165 £130*	3509753 £106	3892367 £123	3509210 £83 £75*	3509449 £88 £86*

Soft Close hinge pack ▲	A x 1 + H x 1	P x ††	P x ††	ASC x 2 (Larder) G x 2 (F/F) A+x 2(Larder)	ASC x 2 (Larder) G x 2 (F/F) A+x 2(Larder)	P x ††	P x †††	ASC x 1	ASC x 1
Push to open ▲	A + x 1 + H x 1	-	-	-	-	-	-	A + x 1	A + x 1

F Framed	W600 x H280mm	W291 x H720mm x 2	W291 x H900mm x 2	W600 x H960mm x 2	W600 x H960mm x 1 W600 x H1140mm x 1	W357 x H720mm x 2	W357 x H720mm x 2	W300 x H720mm	W300 x H900mm
Woburn	3338711 £62	3466605 £99 £93*	3466612 £121 £99*	3338728 £160 £105*	3339015 £165 £130*	3466636 £106	3895566 £123	3338735 £83 £75*	3338988 £88 £86*
Clevedon ▲	3338254 £75 £62*	3466261 £130 £93*	3466278 £150 £99*	3338261 £200 £105*	3338544 £210 £130*	3466285 £150 £106*	3892343 £160 £123*	3338278 £93 £75*	3338513 £95 £86*
Carisbrooke Ivory Framed ▲	3800737 £77 £62*	5397007141030 £93 £85*	5397007142600 £147 £99*	3800751 £205 £105*	3802106 £215 £130*	3802380 £154 £106*	3894729 £164 £123*	5397007149685 £80 £75*	5397007142617 £95 £86*
Carisbrooke Taupe Framed ▲	3872802 £77 £62*	5397007141061 £93 £85*	5397007142693 £147 £99*	3872840 £205 £105*	3872857 £215 £130*	3872888 £154 £106*	3894736 £164 £123*	5397007149708 £80 £75*	5397007142709 £95 £86*
Chillingham	3875483 £83 £62*	3875490 £138 £93*	3875605 £160 £99*	3875612 £220 £105*	3875629 £231 £130*	3874905 £165 £106*	3894774 £176 £123*	3874912 £99 £75*	3874929 £105 £86*

Soft Close hinge pack ▲	D x 1 + H x 1	E x 1	E x 1	DSC x 2	DSC x 2	E x 1	B x 1	DSC x 1	DSC x 1
Hinge pack ▲	L x 1 + H x 1	M x 1	M x 1	L x 2	L x 2	M x 1	M x 1	L x 1	L x 1

† Appleby, Solid oak, Solid ash and Oak veneer shaker which require 2 x hinge pack C. These kitchens include a corner post. ‡ This door is only compatible with a self adhesive integrated handle. †† Except Appleby, which requires 2 x hinge pack C.



*New glass door range.
Pack G/G1
See page 41



NF Non-framed	W497 x H715mm	W497 x H895mm	W597 x H115mm	W597 x H715mm	W597 x H557mm	W597 x H737mm	W597 x H453mm	W597 x H633mm
High Gloss walnut ▲	- -	3878996 £78 £72*	3879009 £30 £26*	3695722 £57 £52*	-	-	-	-
High gloss white ▲	3676608 £70 £64* 5397007041118 £70** £64*	3676929 £78 £72* 5397007041132 £78** £72*	3676615 £30 £26*	3676707 £57 £52*	3676714 £50 £46*	3676943 £55 £51*	3676721 £47 £43*	3676950 £42 £39*
High gloss cream ▲	3675991 £70 £64* 5397007041231 £70** £64*	3676240 £78 £72* 5397007041255 £78** £72*	3676004 £30 £26*	3676011 £57 £52*	3676028 £50 £46*	3676264 £55 £51*	3676035 £47 £43*	3676271 £42 £39*
High gloss black ▲	3594766 £70 £64* 5397007041354 £70** £64*	3689608 £78 £72* 5397007041378 £78** £72*	3526507 £30 £26*	3526514 £57 £52*	3526521 £50 £46*	3689615 £55 £51*	3526538 £47 £43*	3689622 £42 £39*
High gloss red ▲	3593844 £70 £64*	3689196 £78 £72*	3526255 £30 £26*	3526262 £57 £52*	3526279 £50 £46*	3689301 £55 £51*	3526286 £47 £43*	3526231 £42 £39*
High gloss Aubergine ▲	3697702 £70 £64*	3878453 £78 £72*	3878460 £30 £26*	4098003 £57 £52*	4023838 £50 £46*	4023845 £55 £51*	4023852 £47 £43*	4023869 £42 £39*
Appleby cream ▲	3872147 £77 £76* 5397007040999 £77** £76*	3872154 £84 £83* 5397007041019 £84** £83*	3872161 £36 £28*	3872178 £64 £63*	3872185 £65 £64*	3872192 £66 £65*	3872208 £58 £57*	3872062 £54 £53*
Appleby white ▲	4012047 £77 £76* 5397007040883 £77** £76*	4012078 £84 £83* 5397007040890 £84** £83*	4012108 £36 £28*	4012139 £64 £63*	4012153 £65 £64*	4012184 £66 £65*	4012214 £58 £57*	4011828 £54 £53*
Farleigh	3874578 £89	3874585 £97	3874592 £44	3874608 £74	3874615 £72	3874622 £76	3874639 £67	3874493 £62
Solid oak ▲	3097724 £79 £64*	3694657 £87 £72*	3097731 £35 £26*	3097717 £70 £52*	3097700 £68 £46*	3694664 £70 £51*	3097694 £63 £43*	3097779 £57 £39*
Solid oak classic	3298329 £85 £64*	-	3298336 £35 £26*	3298343 £70 £52*	3298350 £68 £46*	-	3298367 £63 £43*	-
Carisbrooke Ivory ▲	5397007124859 £89	5397007140255 £97	5397007124866 £44	5397007124873 £74	5397007124880 £72	5397007140262 £76	5397007124897 £67	5397007140279 £62
Carisbrooke Taupe ▲	5397007125238 £89	5397007140422 £97	5397007125245 £44	5397007125252 £74	5397007125269 £72	5397007140439 £76	5397007125276 £67	5397007140446 £62
Hedingham	3509227 £89	3509456 £97	3509234 £44	3509241 £74	3509258 £72	3509470 £88 £76*	3509265 £67	3509173 £62
Soft Close hinge pack ▲	ASC x 1	ASC x 1	-	-	ASC x 1	ASC x 1	ASC x 1	ASC x 1
Push to open ▲	A+ x 1	A+ x 1	-	-	A+ x 1	A+ x 1	A+ x 1	A+ x 1

F Framed	W500 x H720mm	W500 x H900mm	W600 x H115mm	-	W600 x H562mm	W600 x H742mm	W600 x H460mm	W600 x H638mm
Woburn	3338742 £89	3338995 £97	3338759 £44	-	3338773 £72	3339022 £88 £76*	3338780 £67	3339039 £77 £62*
Clevedon ▲	3338285 £103 £89*	3338520 £108 £97*	3338292 £44	-	3338315 £85 £72*	3338551 £90 £76*	3338322 £80 £67*	3338568 £85 £62*
Carisbrooke Ivory Framed ▲	5397007149692 £100 £89*	5397007142624 £106 £97*	3801024 £44	-	3801079 £87 £72*	3802120 £92 £76*	3801086 £82 £67*	3802137 £87 £62*
Carisbrooke Taupe Framed ▲	5397007149715 £100 £89*	5397007142716 £106 £97*	3872932 £44	-	3872963 £87 £72*	3872970 £92 £76*	3872994 £82 £67*	3873007 £87 £62*
Chillingham	3874936 £103 £89*	3874943 £116 £97*	3874950 £44	-	3874981 £94 £72*	3874998 £99 £76*	3875117 £88 £67*	3875124 £94 £62*
Soft Close hinge pack ▲	DSC x 1	DSC x 1	-	-	DSC x 1	DSC x 1	DSC x 1	DSC x 1
Hinge pack ▲	L x 1	L x 1	-	-	L x 1	L x 1	L x 1	L x 1

*Not compatible with integrated appliances with hinge fixing at the top of the door. Check your appliance details carefully. If your appliance is not compatible choose Appleby in drawer line format and invert the drawer front.

Step 2

Pick your doors & drawer fronts (excluding hinges*)

**NEW
LOWER
PRICE**

**COOKE
& LEWIS**



NF Non-framed	W147 x H715mm	W297 x H156mm x1 W297 x H557mm x1	W397 x H715mm	W397 x H895mm	W447 x H715mm	W447 x H895mm	W397 x H156mm x 1 W397 x H557mm x 1	W447 x H156mm x 1 W497 x H557mm x 1	W497 x H156mm x 1 W497 x H557mm x 1
High Gloss walnut ▲	-	3879016 £47 £43*	-	-	-	-	-	-	3695739 £52
High gloss white ▲	3676738 £27 £25*	3676745 £47 £43*	3676752 £47 £43*	3676882 £52 £48*	3689943 £45 £41*	3689950 £47 £43*	3676769 £50 £46*	3689967 £52 £48*	3676776 £52
High gloss cream ▲	3676042 £27 £25*	3676059 £47 £43*	3676066 £47 £43*	3676196 £52 £48*	3689981 £45 £41*	3689998 £47 £43*	3676073 £50 £46*	3690000 £52 £48*	3676080 £52
High gloss black ▲	3526545 £27 £25*	3594773 £47 £43*	3526552 £47 £43*	3689639 £52 £48*	3689516 £45 £41*	3689646 £47 £43*	3594780 £50 £46*	3689523 £52 £48*	3594797 £52
High gloss red ▲	3526293 £27 £25*	3593851 £47 £43*	3526309 £47 £43*	3689325 £52 £48*	3689103 £45 £41*	3689332 £47 £43*	3593868 £50 £46*	3689110 £52 £48*	3593875 £52
High gloss aubergine ▲	4023876 £27 £25*	3878477 £47 £43*	4023883 £47 £43*	4023890 £52 £48*	4023906 £45 £41*	4023913 £47 £43*	4023920 £50 £46*	4023937 £52 £48*	3695142 £52
Appleby cream ▲	3872222 £40 £39*	3872239 £58 £57*	3872246 £56 £55*	3872253 £59 £58*	3872260 £55 £54*	3872277 £56 £55*	3872284 £62 £61*	3872291 £65 £64*	3872307 £66
Appleby white ▲	4012269 £40 £39*	4012290 £58 £57*	4012320 £56 £55*	4012351 £59 £58*	4012375 £55 £54*	4012405 £56 £55*	4012436 £62 £61*	4012467 £65 £64*	4012481 £66
Farleigh ▲	3874653 £46	3874660 £67	3874677 £65	3874684 £68	3874691 £66	3874707 £73	3874714 £69	3874721 £72	3874738 £74
Solid oak ▲	3097687 £42 £25*	3097670 £62 £43*	3097663 £62 £43*	3694695 £63 £48*	3694541 £57 £41*	3694701 £58 £43*	3097618 £66 £46*	3694558 £68 £48*	3097625 £67 £52*
Solid oak classic ▲	3298374 £42 £25*	3298381 £62 £43*	3298398 £62 £43*	-	3694800 £57 £41*	-	3298404 £66 £46*	3694817 £68 £48*	3298411 £67 £52*
Carisbrooke Ivory ▲	5397007124903 £46	5397007124910 £67	5397007124927 £65	5397007140286 £68	5397007125030 £66	5397007140330 £60 £73*	539700714934 £69	5397007125047 £72	5397007124941 £74
Carisbrooke Taupe ▲	5397007125283 £46	5397007125290 £67	5397007125306 £65	5397007140453 £68	5397007125412 £66	5397007140507 £60 £73*	5397007125313 £69	5397007125429 £72	5397007125320 £74
Hedingham ▲	3509272 £46	3509289 £77 £67*	3509296 £77 £65*	3509418 £79 £68*	3690192 £72 £66*	3690208 £73	3509302 £79 £69*	3690215 £83 £72*	3509319 £83 £74*
Soft Close hinge pack ▲	-	ASC x 1	ASC x 1	ASC x 1	ASC x 1	ASC x 1	ASC x 1	ASC x 1	ASC x 1
Push to open ▲	-	A+ x 1	A+ x 1	A+ x 1	A+ x 1	A+ x 1	A+ x 1	A+ x 1	A+ x 1

F Framed	W147 x H718mm	W300 x H720mm	W400 x H720mm	W400 x H900mm	W450 x H720mm	W450 x H900mm	W400 x H720mm	W450 x H720mm	W500 x H720mm
Woburn ▲	3338797 £46	3338803 £77 £67*	3338810 £77 £65*	3338957 £79 £68*	3690109 £72 £66*	3690116 £73	3338827 £79 £69*	3690123 £83 £72*	3338834 £80 £74*
Clevedon ▲	3338339 £46	3338346 £80 £67*	3338353 £80 £65*	3338483 £90 £68*	3690031 £88 £66*	3690048 £93 £73*	3338360 £85 £69*	3690055 £93 £72*	3338377 £90 £74*
Carisbrooke Ivory Framed ▲	3801093 £46 £42*	3801321 £82 £67*	3801345 £82 £65*	5397007142631 £85 £68*	3801383 £90 £66*	5397007142648 £90 £73*	3801376 £87 £69*	3801543 £95 £72*	3801567 £92 £74*
Carisbrooke Taupe Framed ▲	3873021 £46 £42*	3873038 £82 £67*	3873045 £82 £65*	5397007142723 £85 £68*	3873076 £90 £66*	5397007142730 £90 £73*	3873106 £87 £69*	3873113 £95 £72*	3873120 £92 £74*
Chillingham ▲	3875148 £46 £42*	3875155 £88 £67*	3875162 £84 £65*	3875179 £94 £68*	3875186 £97 £66*	3875193 £99 £73*	3875308 £94 £69*	3875315 £102 £72*	3875322 £99 £74*
Soft Close hinge pack ▲	-	DSC x 1	DSC x 1	DSC x 1	DSC x 1	DSC x 1	DSC x 1	DSC x 1	DSC x 1
Hinge pack ▲	-	L x 1	L x 1	L x 1	L x 1	L x 1	L x 1	L x 1	L x 1

Cooke & Lewis door and drawer fronts



NF Non-framed	W597 x H715mm	W597 x H895mm	W597 x H156mm x 1 W597 x H557mm x 1	W797 x H156mm x 1 W797 x H277mm x 2	W597 x H1197mm	W597 x H1377mm	W297 x H956mm x 2	W297 x H956mm x 1 W297 x H1136mm x 1	W497 x H841mm x 1 W497 x H156mm x 2
High Gloss walnut ▲	3695722 £55 £51*	3879023 £60 £55*	3879030 £60 £55*	3695760 £67 £62*	-	-	-	-	-
High gloss white ▲	3676783 £55 £51*	3676905 £60 £55*	3676790 £60 £55*	3676806 £67 £62*	3676813 £67 £62*	3676820 £72 £66*	3676837 £75 £69*	3676967 £77 £71*	3676844 £85 £78*
High gloss cream ▲	3676097 £55 £51*	3676226 £60 £55*	3676103 £60 £55*	3676110 £67 £62*	3676127 £67 £62*	3676134 £72 £66*	3676141 £75 £69*	3676288 £77 £71*	3676158 £85 £78*
High gloss black	3526569 £55 £51*	3689653 £60 £55*	3594803 £60 £55*	3526576 £67 £62*	3526583 £67 £62*	3689660 £72 £66*	3526590 £75 £69*	3689677 £77 £71*	3689684 £85 £78*
High gloss red ▲	3526316 £55 £51*	3689349 £60 £55*	3593882 £60 £55*	3526323 £67 £62*	3526330 £67 £62*	3689356 £72 £66*	3526347 £75 £69*	3689363 £77 £71*	3689370 £85 £78*
High gloss aubergine ▲	3695135 £55 £51*	3878484 £60 £55*	3878491 £60 £55*	3695173 £67 £62*	4023944 £67 £62*	4023951 £72 £66*	4023968 £75 £69*	4023975 £77 £71*	4023982 £85 £78*
Appleby cream ▲	3872314 £64 £63*	3872321 £67 £66*	3872338 £72 £71*	3872345 £77 £76*	3872352 £84 £83*	3872369 £79 £87*	3872376 £82 £81*	3872383 £84 £83*	3872390 £92 £90*
Appleby white ▲	4012498 £64 £63*	4012610 £67 £66*	4012641 £72 £71*	4012665 £77 £76*	4012696 £84 £83*	4012726 £79 £87*	4012757 £82 £81*	4012788 £84 £83*	4012825 £92 £90*
Farleigh	3874745 £72	3874752 £77	3874769 £76	3874776 £85	3874783 £86	3874790 £92	3874806 £95	3874813 £110	3874820 £109
Solid oak ▲	3097632 £70 £51*	3694718 £72 £55*	3097649 £76 £55*	3097656 £84 £62*	3097601 £90 £62*	3694725 £84 £66*	3305232 £84 £69*	3694732 £90 £71*	3694749 £99 £78*
Solid oak classic	3298428 £70 £51*	-	3298435 £76 £55*	3298442 £84 £62*	3298459 £90 £62*	-	3305096 £84 £69*	-	-
Carisbrooke Ivory ▲	5397007124968 £72	5397007140293 £77	5397007124965 £78 £76*	5397007124972 £86 £85*	5397007124989 £92 £86*	5397007140309 £92	5397007124996 £95	5397007140316 £110	5397007125009 £109
Carisbrooke Taupe ▲	5397007125337 £72	5397007140460 £77	5397007125344 £78 £76*	5397007125351 £86 £85*	5397007125368 £92 £86*	5397007140477 £92	5397007125375 £95	5397007140484 £110	5397007125382 £109
Hedingham	3509326 £85 £72*	3509432 £88 £77*	3509333 £88 £76*	3509340 £96 £85*	3509357 £105 £86*	3509494 £110 £92*	3509364 £112 £95*	3509500 £125 £110*	3509371 £125 £109*
Soft Close hinge pack ▲	ASC x 1	ASC x 1	ASC x 1	-	G x 1	G x 1	ASC x 2	ASC x 2	ASC x 1
Push to open ▲	A+ x 1	A+ x 1	A+ x 1	-	-	-	A+ x 2	A+ x 2	A+ x 1

F Framed	W600 x H720mm	W600 x H900mm	W600 x H720mm	W800 x H720mm	W597 x H1197mm	W597 x H1377mm	W300 x H960mm x 2	W300 x H960mm x 1 W300 x H1140mm x 1	W500 x H1162mm
Woburn	3338841 £85 £72*	3338971 £88 £77*	3338858 £88 £76*	3338865 £96 £85*	3338872 £105 £86*	3339046 £85 £92*	3338896 £121 £95*	3339053 £118 £110*	3338902 £127 £109*
Clevedon ▲	3338384 £95 £72*	3338506 £103 £77*	3338391 £95 £76*	3338407 £100 £85*	3338414 £95 £86*	3338575 £95 £92*	3338421 £130 £95*	3338582 £135 £110*	3338438 £135 £109*
Carisbrooke Ivory Framed ▲	3801574 £97 £72*	5397007142655 £101 £77*	3801703 £97 £76*	3801727 £103 £85*	3801734 £97 £86*	3802151 £97 £92*	3801758 £133 £95*	3802168 £138 £110*	3801765 £138 £109*
Carisbrooke Taupe Framed ▲	3873137 £97 £72*	5397007142747 £101 £77*	3873168 £97 £76*	3873175 £103 £85*	3873182 £97 £86*	3873199 £97 £92*	3873205 £143 £95*	3873212 £138 £110*	3873229 £138 £109*
Chillingham	3875339 £105 £72*	3875346 £110 £77*	3875353 £105 £76*	3875360 £110 £85*	3875377 £105 £86*	3875384 £105 £92*	3875391 £143 £95*	3875506 £149 £110*	3875513 £149 £109*
Soft Close hinge pack ▲	DSC x 1	DSC x 1	DSC x 1	-	G x 1	G x 1	DSC x 2	DSC x 2	DSC x 1
Hinge pack ▲	L x 1	L x 1	L x 1	-	G x 1	G x 1	L x 2	L x 2	L x 1

Step 2

Pick your doors & drawer fronts (excluding hinges*)

**NEW
LOWER
PRICE**

**COOKE
& LEWIS**

--	--	--	--	--	--	--	--	--

NF Non-framed	W497 x H1021mm x 1 W497 x H156mm x 2	W597 x H40mm	W597 x H156mm x 1 W597 x H277mm x 2	W997 x H356mm	W997 x H356mm	W997 x H356mm	W317 x H715mm	W317 x H895mm	H715 x W33.5mm
High Gloss walnut ▲	-	-	-	3695777 £45 £41*	3695784 £65 £60*	3695791 £125 £115*	-	-	-
High gloss white ▲	3676974 £90 £83*	3676851 £21 £19*	3676868 £60	3677162 £45 £41*	3677179 £65 £60*	3677186 £125 £115*	4155416 £165 £152*	4155393 £145 £133*	4155409 £156 £144*
High gloss cream ▲	3676301 £90 £83*	3676165 £21 £19*	3676172 £60	3676516 £45 £41*	3676509 £65 £60*	3676493 £125 £115*	4155447 £165 £152*	4155423 £145 £133*	4155430 £156 £144*
High gloss black ▲	3689691 £90 £83*	3697641 £21 £19*	3689707 £60	3700235 £45 £41*	3700242 £65 £60*	3689745 £125 £115*	4155478 £165 £152*	4155454 £145 £133*	4155461 £156 £144*
High gloss red ▲	3689387 £90 £83*	3697634 £21 £19*	3689394 £60	3700211 £45 £41*	3700228 £65 £60*	3689424 £125 £115*	4155492 £165 £152*	4155485 £145 £133*	-
High gloss aubergine ▲	4023999 £90 £83*	4024002 £21 £19*	4024019 £60	3695180 £45 £41*	3695197 £65 £60*	3695203 £125 £115*	4155522 £165 £152*	4155508 £145 £133*	4155515 £157 £144*
Appleby cream ▲	3872406 £97 £95*	3872413 £24	3872420 £67 £66*	3872437 £52 £51*	3872444 £72 £71*	3872451 £132 £130*	4155553 £172 £169*	4155539 £152 £149*	4155546 £163 £160*
Appleby white ▲	4012863 £97 £95*	4012900 £24	4012962 £67 £66*	4013112 £52 £51*	4013143 £72 £71*	4013181 £132 £130*	4155584 £172 £169*	4155560 £152 £149*	4155577 £163 £160*
Farleigh	3874837 £125	3874844 £28	3874851 £82	3874868 £80	3874875 £85	3874882 £152	4154846 £195	4154822 £175	4154839 £180
Solid oak ▲	3694756 £105 £83*	3697955 £24 £19*	3694763 £72 £60*	-	-	-	-	-	-
Solid oak classic	-	-	3694824 £72 £60*	-	-	-	-	-	-
Carisbrooke Ivory ▲	5397007140323 £125	5397007125016 £28	5397007125023 £82	-	-	-	4161615 £195	4161608 £180 £175*	5397007141610 £180
Carisbrooke Taupe ▲	5397007140491 £125	5397007125399 £28	5397007125405 £82	-	-	-	4161639 £195	4161622 £180 £175*	5397007141603 £180
Hedingham	3509517 £129 £125*	3509388 £28	3509395 £94 £82*	-	-	-	-	-	-
Soft Close hinge pack ▲	ASC x 1	-	-	J x 1 (bridging)	J x 1 (bridging)	-	DSC x 1	DSC x 1	DSC x 1
Push to open ▲	A+ x 1	-	-	J+ x 1 (bridging)	J+ x 1 (bridging)	-	-	-	-

F Framed	W500 x H1342mm	W600 x H40mm	W600 x H720mm	-	-	-	W321 x H720mm	W321 x H720mm	W321 x H900mm
Woburn	3339060 £125	3338919 £28	3338926 £88 £82*	-	-	-	-	-	-
Clevedon ▲	3338599 £140 £125*	3338445 £28	3338452 £100 £82*	-	-	-	4154860 £255 £195*	3690024 £215 £175*	3878743 £243 £180*
Carisbrooke Ivory Framed ▲	3802182 £144 £125*	3801789 £28	3801901 £103 £82*	-	-	-	4154891 £256 £195*	3820810 £215 £175*	4167204 £243 £180*
Carisbrooke Taupe Framed ▲	3873236 £144 £125*	3873243 £28	3873250 £103 £82*	-	-	-	4155201 £256 £195*	3873267 £215 £175*	4167211 £243 £180*
Chillingham	3875520 £154 £125*	3875537 £28	3875544 £110 £82*	-	-	-	-	-	-
Soft Close hinge pack ▲	DSC x 1	-	-	-	-	-	-	DSC x 1	DSC x 1
Hinge pack ▲	L x 1	-	-	-	-	-	-	-	-

** Base only on framed doors. † When using packs Z and Za as a bridging door, hinge pack J or J+ will need to be ordered separately. These hinge packs include a gas stay kit.

Cooke & Lewis door and drawer fronts

Step 2

Pick your doors & drawer fronts (excluding hinges*)

**NEW
LOWER
PRICE**

COOKE
& LEWIS

40

Cooke & Lewis door and drawer fronts



NF Non-framed	W317 x H870mm	W317 x H715mm	W317 x H900mm
High Gloss walnut ▲	-	-	-
High gloss white ▲	5397007124736 £105	5397007124712 £105	5397007124699 £105
High gloss cream ▲	5397007124743 £105	5397007124729 £105	5397007124705 £105
High gloss black	-	-	-
High gloss red ▲	-	-	-
High gloss aubergine ▲	-	-	-
Appleby cream ▲	-	-	-
Appleby white ▲	-	-	-
Farleigh	-	-	-
Solid oak ▲	-	-	-
Solid oak classic	-	-	-
Carisbrooke Ivory ▲	-	-	-
Carisbrooke Taupe ▲	-	-	-
Hedingham	-	-	-

Step 2

Fixed frame appliance doors

COOKE
& LEWIS

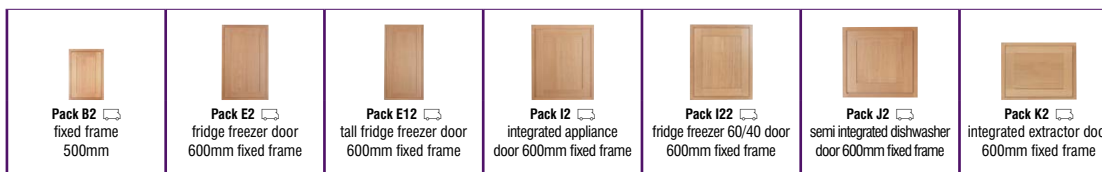

F Framed	W497 x H715mm	W597 x H956mm	W597 x H1136mm	W596 x H717mm	W597 x H715mm	W597 x H557mm	W597 x H453mm
Woburn	3516140 £65	3341735 £88	3341766 £110	3338766 £75	3466452 £75	3341742 £66	3341759 £60
Clevedon ▲	3878569 £85	3878583 £100	3341728 £120	3878590 £85	3878705 £85	3878712 £80	3878729 £70
Carisbrooke Framed ▲	3811320 £77	3811337 £103	3811344 £123	3811351 £87	3811368 £87	3811375 £82	3832769 £72
Carisbrooke Taupe Framed ▲	3872758 £77	3872864 £103	3872871 £123	3872949 £87	3872956 £87	3872987 £82	3873014 £72
Chillingham	3875438 £83	3875636 £110	3875643 £123	3874967 £94	3874974 £94	3875100 £88	3875131 £77

Step 2











Pick your doors & drawer fronts (excluding hinges*)

 Pack AS standard door 300mm	 Pack AS1 tall standard door 300mm	 Pack AAS deep bridging door 500mm	 Pack BS standard door 500mm	 Pack BS1 tall standard door 500mm	 Pack DS bridging door 600mm	 Pack DDS 625mm corner door	 Pack DDS1 625mm tall corner door
---	---	---	---	---	--	--	--

F Framed for Carisbrooke wall cabinets with integrated pelmet	W300 x H760mm	W300 x H940mm	W500 x H485mm	W500 x H760mm	W500 x H940mm	W600 x H320mm	W291 x H760mm x 2	W291 x H940mm x 2
Carisbrooke Taupe ▲	3872666 £55	3872680 £57	3872703 £52	3872727 £52	3872741 £69	3872819 £57	3872826 £95	3872833 £99
Carisbrooke Ivory ▲	3799994 £55	3801918 £57	3802199 £52	3800713 £52	3801949 £69	3820636 £57	3802359 £95	3802373 £99
SC hinge pack ▲	DSC x 1	DSC x 1	DSC x 1	DSC x 1	DSC x 1	D x 1 H x 1	E x 1	E x 1

 Pack FS glazed door 300mm	 Pack FS1 tall glazed door 300mm	 Pack GS glazed door 500mm	 Pack GS1 tall glazed door 500mm	 Pack NS standard door 400mm	 Pack NS1 tall standard door 400mm	 Pack NS+ standard door 450mm	 Pack N1S+ tall standard door 450mm	 Pack RS standard door 600mm	 Pack RS1 tall standard door 600mm
---	---	---	---	---	---	--	--	---	---









F Framed for Carisbrooke wall cabinets with integrated pelmet	W300 x H760mm	W300 x H940mm	W500 x H760mm	W500 x H940mm	W400 x H760mm	W400 x H940mm	W450 x H760mm	W450 x H940mm	W600 x H760mm	W600 x H940mm
Carisbrooke Taupe ▲	3872895 £69	3872901 £70	3872918 £77	3872925 £79	3873052 £60	3873069 £62	3873083 £63	3873090 £65	3873144 £69	3873151 £72
Carisbrooke Ivory ▲	3800768 £69	3801970 £70	3800799 £77	3801994 £79	3801352 £60	3801932 £62	3801505 £63	3801512 £65	3801598 £69	3801963 £72
SC hinge pack ▲	DSC x 1	DSC x 1	DSC x 1	DSC x 1	DSC x 1	DSC x 1	DSC x 1	DSC x 1	DSC x 1	DSC x 1

 Wall curved door with int pelmet LH	 Wall curved door with int pelmet RH	 Tall wall curved door with int pelmet LH	 Tall wall curved door with int pelmet RH	 OP2S open end wall frame with int. pelmet LH	 OP2S open end wall frame with int. pelmet RH	 OP3S open end tall wall frame with int. pelmet LH	 OP3S open end tall wall frame with int. pelmet RH	 Pack OP4S open frame 500mm with int. pelmet	 Pack OP5S wine rack frame 150mm with int. pelmet
---	---	--	--	---	---	--	--	--	---

F Framed for Carisbrooke wall cabinets with integrated pelmet	W321 x H760mm	W321 x H760mm	W321 x H940mm	W321 x H940mm	W300 x H760mm	W300 x H760mm	W300 x H940mm	W300 x H940mm	W500 x H760mm	W150 x H760mm
Carisbrooke Taupe ▲	3873274 £170	3873281 £170	3873298 £185	3873304 £185	3873335 £35	3873342 £35	3873359 £35	3873366 £35	3873380 £35	3873403 £35
Carisbrooke Ivory ▲	3820803 £170	3803448 £170	3878750 £185	3878767 £185	3820643 £35	3820557 £35	3820650 £35	3820564 £35	3820595 £35	3820667 £35
SC hinge pack ▲	DSC x 1	DSC x 1	DSC x 1	DSC x 1	-	-	-	-	-	-

▲ Our Banbury, Bedford, Burgess Hill, Bognor Regis, Consett, Eastleigh, Fareham, Hedge End, Nursling, Poole, Portsmouth, Port Glasgow and Sydenham stores stock a wide range of products – all available to take away. The symbol is used throughout this Buying Guide to indicate the products that these stores stock. However these are subject to availability and ranges may vary by store.

Colour matched frames

							
Pack OP1 ☐ open end base frame	Pack OP2 ☐ open end wall frame (LH or RH)	Pack OP3 ☐ open end tall wall frame (LH or RH)	Pack OP4 ☐ open frame 500mm	Pack OP5 ☐ wine rack frame 150mm	Pack OP5+ ☐ tall wine rack frame 150mm	Pack OP6 ☐ wine rack insert to fit 500mm base or wall unit	Pack OP7 ☐ plate rack insert to fit 500mm base or wall unit

NF Non-framed	H715 x W267mm	W300 x H720mm & W570 x H720mm	W300 x H720mm & W335 x H720mm	W300 x H900mm & W335 x H900mm	W500 x H720mm	W150 x H900mm	To fit 500mm base or wall unit	To fit 500mm base or wall unit
HG horizontal walnut ▲	-	-	-	-	-	-	-	-
High gloss white ▲	-	-	-	3677049 £50	3677056 £40	5397007125580 £50	3466896 £100	-
High gloss cream ▲	-	-	-	3676370 £50	3676387 £40	5397007125597 £50	3466896 £100	-
High gloss black	-	-	-	3689813 £50	3813355 £40	-	-	-
High gloss red ▲	-	-	-	3689493 £50	3813195 £40	-	-	-
HG aubergine ▲	-	-	-	4024101 £50	4024118 £40	-	-	-
Appleby cream ▲	-	-	-	3872499 £50	3872505 £40	5397007125610 £50	-	-
Appleby white ▲	-	-	-	4013440 £50	4013488 £40	5397007125603 £50	-	-
Farleigh	-	-	-	3875025 £50	3875032 £40	-	-	-
Solid oak ▲	-	-	-	3701171 £50	3701188 £45	-	3466872 £105	3466889 £64
Solid oak classic	-	-	-	-	-	-	3466872 £105	3466889 £64
Hedingham	3509524 £66	3509531 £55	3509548 £50	3509555 £55	3509562 £44	-	3466872 £105	3466889 £64
Carisbrooke Ivory ▲	3802533 £62	5397007141047 £55	5397007141054 £50	3802588 £51	3802717 £41	-	3466872 £105	3466889 £64
Carisbrooke Taupe ▲	3873328 £62	5397007141078 £55	5397007141085 £50	3873373 £51	3873397 £41	-	3466872 £105	3466889 £64

F Framed	W300 x H720mm & W570 x H720mm	W300 x H720mm & W335 x H720mm	W300 x H900mm & W335 x H900mm	W500 x H720mm	W150 x H720mm	-	To fit 500mm base or wall unit	To fit 500mm base or wall unit
Woburn	3356357 £66	3356364 £55	3356371 £50	3356388 £55	3356395 £44	-	3466872 £105	3466889 £64
Clevedon ▲	3356159 £60	3356166 £50	3356173 £50	3356180 £50	3356197 £40	-	3466872 £105	3466889 £64
Carisbrooke Ivory Framed ▲	3802533 £62	-	-	3802588 £51	3802717 £41	-	3466872 £105	3466889 £64
Carisbrooke Taupe Framed ▲	3873328 £62	-	-	3873373 £51	3873397 £41	-	3466872 £105	3466889 £64
Chillingham	3875551 £66	3875568 £55	3873632 £50	3875704 £55	3875711 £44	-	-	3892022 £77

Step 3

Pick your accessories

Clad-on end panels



	W359 x D22 x H757mm	W359 x D22 x H937mm	W359 x D22 x H1342mm	W594 x D22 x H900mm	n/a	W594 x D22 x H2280mm
Woburn T&G	3339077 £52	3339084 £62	3339091 £72	3339107 £82	–	3339114 £115
Clevedon ▲	3338605 £52	3338612 £62	3338629 £72	3338636 £82	–	3338643 £115
Carisbrooke Taupe Framed T&G ▲	3873410 £52	3873427 £62	3873434 £72	3873441 £82	–	3873458 £115
Carisbrooke Taupe T&G ▲	3873410 £52	3873427 £62	3873434 £72	3873441 £82	–	3873458 £115
Carisbrooke Framed T&G ▲	3803226 £52	3803288 £62	3803295 £72	3803240 £82	–	3803257 £115
Carisbrooke Ivory T&G ▲	3803226 £52	3803288 £62	3803295 £72	3803240 £82	–	3803257 £115
Hedingham	3505717 £52	3505724 £62	3505731 £72	3505748 £82	–	3505755 £115
Appleby Cream ▲	3872512 £50	3872529 £60	3872536 £70	3872543 £80	–	3872550 £95
Appleby White ▲	4013525 £50	4013570 £60	4013600 £70	4013648 £80	–	4013679 £95

	W355 x D22 x H760mm	W355 x D22 x H940mm	W355 x D22 x H1342mm	W590 x D22 x H900mm	n/a	W590 x D22 x H2280mm
High gloss red	3685808 £44	3685839 £58	3685822 £68	3685792 £76	–	3685815 £90
High gloss black ▲	3685853 £44	3685884 £58	3685877 £68	3685846 £76	–	3685860 £90
High gloss cream	3676318 £44	3676325 £58	3676332 £68	3676349 £76	–	3676356 £90
High gloss white ▲	3676981 £44	3676998 £58	3677001 £68	3677018 £76	–	3677025 £90
High gloss horizontal walnut ▲	3682357 £44	3698174 £58	–	3682340 £76	–	–
High gloss aubergine ▲	3683149 £44	3697696 £58	4024149 £68	3683132 £76	–	4024156 £90
Farleigh ▲	3875049 £52	3875056 £62	3875063 £72	3875070 £82	–	3875087 £115

	W355 x D22 x H772mm	W355 x D22 x H952mm	W355 x D22 x H1342mm	W590 x D22 x H900mm	W590 x D22 x H2100mm	W590 x D22 x H2280mm
Solid oak classic ▲	3680407 £44	–	–	3680414 £76	3680421 £90	–
Solid oak ▲	3680353 £44	3680377 £58	3680384 £68	3680360 £76	–	3680391 £90
Chillingham T&G ▲	3875728 £52	3875735 £62	3875742 £72	3875759 £82	3875766 £105	3875766 £115



To get this look for your glass cabinets you will need to purchase these glass doors & glass panels

	Pack G glass door W497 x H715mm	Pack G1 tall glass door W497 x H895mm
High gloss white	5397007041118 £70	5397007041132 £78
High gloss cream	5397007041231 £70	5397007041255 £78
High gloss black	5397007041354 £70	5397007041378 £78
Appleby cream	5397007040999 £77	5397007041019 £84
Appleby white	5397007040883 £77	5397007040890 £84

	Replace glass wall panel LH	Replace glass wall panel RH	Replace glass tall wall panel LH	Replace glass tall wall panel RH
High gloss black ▲	5397007041392 £44	5397007041415 £44	5397007041439 £58	5397007041453 £58
High gloss cream ▲	5397007041279 £44	5397007041293 £44	5397007041316 £58	5397007041330 £58
High gloss white ▲	5397007041156 £44	5397007041170 £44	5397007041194 £58	5397007041217 £58
Appleby cream ▲	5397007041279 £44	5397007041293 £44	5397007041316 £58	5397007041330 £58
Appleby white ▲	5397007041156 £44	5397007041170 £44	5397007041194 £58	5397007041217 £58

▲ Our Banbury, Bedford, Burgess Hill, Bognor Regis, Consett, Eastleigh, Fareham, Hedge End, Nursing, Poole, Portsmouth, Port Glasgow and Sydenham stores stock a wide range of products – all available to take away. The symbol is used throughout this Buying Guide to indicate the products that these stores stock. However these are subject to availability and ranges may vary by store.

Some panels are colour-matched melamine. T&G Tongue and groove effect.

Cornices, plinths, pelmets etc.



To complete the look of your dream kitchen you may choose to add a cornice to the top of your wall cabinets and a pelmet to the bottom of you wall cabinets (our cornice/pelmet can be used on both). You may also want to consider hiding the legs of your cabinets with a plinth around the bottom of your kitchen.

Cornice (C)	External curved cornice	Internal curved cornice	Sconce	Pelmet	External curved pelmet	Internal curved pelmet	Pelmet Sconce

High gloss walnut combined cornice/pelmet	▲	3695814	£29					3695814	£29								
High Gloss White combined cornice/pelmet	▲	3677063	£29	3698099	£40			3677063	£29	3698099	£40	5397007124774	£50	4062103	£15		
High Gloss White Quadrant	▲	3803129	£45			5397007124774	£50	4062103	£15	3677063	£29	3698099	£40	5397007124774	£50	4062103	£15
High Gloss Cream combined cornice/pelmet	▲	3676394	£29	3698082	£40			3809136	£15	3676394	£29	3698082	£40	5397007124781	£50	4062110	£15
High Gloss Cream Quadrant	▲	3809082	£45			5397007124781	£50	4062110	£15	3676394	£29	3698082	£40	5397007124781	£50	4062110	£15
High gloss black		3813379	£29	3689783	£40			3809099	£15	3813379	£29	3689783	£40				
High Gloss Red	▲	3813317	£29	3689462	£40					3813317	£29						
High Gloss Aubergine	▲	3813430	£29	4024194	£40					3813430	£29						
Solid oak	▲	3107218	£29							3105269	£29						
Solid oak Classic		3298510	£29							3298527	£29						
Appleby Cream combined cornice/pelmet	▲	3676394	£29	3872611	£40					3676394	£29	3872611	£40				
Appleby White combined cornice/pelmet	▲	3677063	£29	4014102	£40					3677063	£29	4014102	£40				
Farleigh		3875094	£39	3875247	£42					3875094	£39	3875247	£40				
Hedingham		3505533	£39							3505540	£39						
Woburn		3339190	£39							3339206	£39						
Carisbrooke Ivory / Framed Ivory Quadrant	▲	3802779	£39	3803455	£42					5397007125160	£39	5397007125122	£40				
Carisbrooke Ivory / Framed Ivory combined cornice/pelmet	▲	5397007125160	£39	5397007125122	£42			3809143	£15	5397007125160	£39	5397007125122	£40				
Carisbrooke Taupe / Framed Taupe Quadrant	▲	3873526	£39	3873496	£42					5397007125542	£39	5397007125504	£40				
Carisbrooke Taupe / Framed Taupe combined cornice/pelmet	▲	5397007125542	£39	5397007125504	£42			3873533	£15	5397007125542	£39	5397007125504	£40				
Clevedon Standard	▲	3338650	£39	3720127	£42					3338667	£39	3720134	£40				
Clevedon Quadrant	▲	3809006	£47							3338667	£39	3720134	£40				
Clevedon combined cornice/Pelmet	▲	3338667	£39	3720134	£42			3809013	£15	3338667	£39	3720134	£40				
Chillingham		3875773	£39							3875780	£39						

Plinths and corner posts



	Plinth		Corner posts				Standard pilaster	Iron-on edging tape			
	L 2.4m	H750 x W57 x D57mm	H720 x W57 x D57mm	H715 x W32 x D32mm	H715 x W52 x D52mm	H900 x W50mm			10m		
High gloss walnut ▲	3695807	£35	-	3879047	£20	-	-	3687475	£7		
High Gloss White Standard ▲	3677087	£35	3689974	£48	3677032	£20	-	-	3279939	£7	
High Gloss White Quadrant ▲	3677087	£35	3689974	£48	-	-	-	-	-		
High Gloss Cream Standard ▲	3676417	£35	3690017	£48	3676363	£20	-	-	3593523	£7	
High Gloss Cream Quadrant ▲	3676417	£35	3690017	£48	-	-	-	-	-		
High gloss Black ▲	3813362	£35	3689790	£48	3526606	£20	-	-	3593943	£7	
High Gloss Red ▲	3813300	£35	3689479	£48	3526354	£20	-	-	3593639	£7	
High Gloss aubergine ▲	3813423	£35	4024200	£48	3878606	£20	-	-	-		
Solid oak ▲	3514405	£35	-	3105030	£20	-	-	-	3166802	£7	
Solid oak Classic ▲	3514405	£35	-	3105030	£20	-	-	-	3166802	£7	
Appleby Cream ▲	3676417	£35	3690017	£48	3872598	£20	-	-	3593523	£7	
Appleby White ▲	3677087	£35	3689974	£48	3677032	£20	-	-	3279939	£7	
Farleigh ▲	3875216	£43	3875254	£50	3575223	£22	-	-	3892152	£7	
Heddingham	3505557	£43	-	3505564	£22	-	-	-	3821275	£7	
Woburn	3380703	£43	-	3339176	£22	-	-	3356487	£22	3821435	£7
Carisbrooke ▲	3803271	£43	3803479	£50	3802984	£22	-	-	3821503	£7	
Carisbrooke Ivory ▲	3803271	£43	3803479	£50	3802984	£22	5397007125139	£15	5397007125153	£15	
Carisbrooke Taupe ▲	3873472	£43	3873502	£50	3873489	£22	5397007125511	£15	5397007125535	£15	
Clevedon Standard ▲	3333808	£43	3698112	£50	3361924	£22	-	-	3596203	£22	
Clevedon Quadrant ▲	3333808	£43	3698112	£50	-	-	-	-	-		
Clevedon Cornice/pelmet ▲	3333808	£43	3698112	£50	-	-	-	-	-		
Carisbrooke taupe ▲	3873472	£43	3873502	£50	3873489	£22	-	-	3870204	£7	
Chillingham	3875797	£43	-	3875803	£22	-	-	3875810	£22	3897850	£7

Curved and square accessories













	Curved base pilaster kit		Curved wall pilaster kit		Curved tall wall pilaster kit		Curved dresser pilaster kit		Curved tall dresser pilaster kit	
Pilaster kit includes 1 x curved pilaster & 1 x clad-on panel.	H900 x W70 x D590mm	H757* x W70 x D355mm	H937†† x W70 x D355mm	H1342 x W70 x D355mm	H1342 x W70 x D355mm					
High gloss cream ▲	3832707	£100	3832714	£100	3830062	£75	3830055	£100	3830055	£100
High gloss white ▲	3832721	£100	3832738	£100	3830086	£75	3830079	£100	3830079	£100
Clevedon ▲	3832486	£100	3832493	£100	3830048	£75	3830031	£100	3830031	£100
Carisbrooke taupe ▲	4017066	£100	4017073	£100	4017080	£75	4017097	£100	4017097	£100
Carisbrooke* ▲	3832455	£100	3832462	£100	3830611	£75	3830635	£100	3830635	£100

	Square base pilaster kit		Square wall pilaster kit		Square tall wall pilaster kit		Square dresser pilaster kit		Square tall dresser pilaster kit	
Pilaster kit includes 1 x pilaster & 2 x clad-on panel.	H900 x W115 x D594mm	H760 x W115 x D359mm	H940 x W115 x D359mm	H1162 x W115 x D359mm	H1342 x W115 x D359mm					
Carisbrooke T&G ▲	3830673	£160	3830666	£100	3830628	£70	3830642	£140	3830659	£140
Carisbrooke taupe ▲	4063308	£160	4063315	£100	-	-	-	-	-	-
Chillingham ▲	4017493	£160	4017509	£100	4017516	£70	4017523	£140	4017530	£140
Carisbrooke* ▲	3830673	£160	3830666	£100	3830628	£70	3830642	£140	3830659	£140



Plinth heater ▲	1800mm x D16mm Wide plinth sealing strip clear		1800mm x D16mm Wide plinth sealing strip white		1800mm x D18mm Wide plinth fixing strip white		1800mm x D18mm Wide plinth fixing strip clear		Ventilation grille metallic silver effect W389 x H65mm		
4077411	£99	5012176460033	£6	5060135377687	£6	5060135377717	£5	5060135379025	£5	3360118	£3

The images shown do not necessarily represent the actual style as these vary by kitchen range. Visit www.diy.com or ask in-store for further details.
 † Except Carisbrooke which is H760mm. †† Except Carisbrooke which is H940mm.
 T&G Carisbrooke clad-on panels have a tongue and groove effect surface.

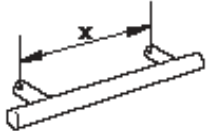



Bow handles

- | | | | |
|---|--|--|---|
|  <p>Bow handle
■ 110mm (96mm c-c)
Matt black
5033614 Per pair £5</p> |  <p>Punched bow handle
■ Brushed nickel finish
■ 2 Sizes
113mm (96mm c-c) ▲
3596494 Per pair £5
198mm (160mm c-c) ▲
3596517 Per pair £8</p> |  <p>Classic bow handle
■ 120mm (76mm c-c)
Pewter effect ▲
3323717 Per pair £7</p> |  <p>Classic square foot bow handle
■ 175mm (160mm c-c)
Antique pewter effect
3517604 Per pair £9</p> |
|  <p>Bow foot handle
■ 155mm (128mm c-c)
Brushed nickel finish ▲
5033539 Per pair £9</p> |  <p>Wide bow handle
■ 194mm (160mm c-c)
Brushed nickel finish ▲
3361009 Per pair £9</p> |  <p>Arched bow handle
■ 190mm (160mm c-c)
Aluminium effect
3513835 Per pair £9</p> |  <p>Bow handle
■ 128mm (84mm c-c)
Pewter effect
3511053 Per pair £10</p> |
|  <p>Narrow bow handle
■ 175mm (128mm c-c)
Antique pewter effect ▲
3596425 Per pair £8</p> |  <p>Grooved bow handle
■ 175mm (160mm c-c)
Antique pewter effect ▲
3596258 Per pair £9</p> |  <p>Sleek bow handle
■ Chrome finish
■ 2 Sizes
460mm (384mm c-c)
3688045 Per pair £15
560mm (480mm c-c)
3600504 Per pair £15</p> |  <p>Snake handle
■ 210mm (192mm c-c)
Chrome effect
3896716 Per pair £14</p> |
|  <p>Chunky bow handle
■ Stainless steel effect
■ 2 Sizes
232mm (224mm c-c)
3693629 Per pair £16
328mm (320mm c-c)
3693605 Per pair £20</p> | <div data-bbox="371 1113 904 1361" data-label="Complex-Block"> <p><i>don't forget...</i></p> <p>All handles are sold in pairs. c-c = centre to centre refers to the measurements between each screw on the handle</p>  </div> | | |























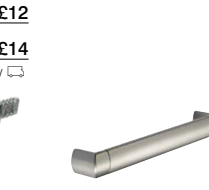



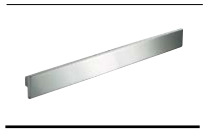

Cut-out handles

- | | | |
|--|---|--|
|  <p>Slimline small cut-out handle
■ Chrome polished effect
■ 2 Sizes
256mm (192mm c-c)
3693582 Per pair £15
352mm (288mm c-c)
3693520 Per pair £15</p> |  <p>Slimline bridge cut-out handle
■ Chrome polished effect
■ 2 Sizes
224mm
4016632 Per pair £17
330mm
4016649 Per pair £18</p> |  <p>Slimline large cut-out handle
■ Chrome polished effect
■ 2 Sizes
256mm (192mm c-c)
3693506 Per pair £15
352mm (288mm c-c)
3693483 Per pair £18</p> |
|--|---|--|

Rod handles

- | | | |
|---|---|--|
|  <p>Aluminium rod handle
■ 220mm (160mm c-c)
Matt aluminium effect
3361030 Per pair £8</p> |  <p>Tri-linear handle
■ 172mm (128mm c-c)
Brushed nickel finish ▲
3360996 Per pair £9</p> |  <p>Chunky contemporary 'D' handle
■ 170mm (128mm c-c)
Matt chrome effect ▲
3323557 Per pair £8</p> |
|  <p>Rod handle
■ Brushed nickel finish
■ 7 Sizes
188mm (128mm c-c) ▲
3360965 Per pair £8
220mm (160mm c-c) ▲
3177211 Per pair £10
344mm (288mm c-c) ▲
3177228 Per pair £11
476mm (416mm c-c) ▲
3323700 Per pair £12
510mm (450mm c-c) ▲
3177709 Per pair £14
668mm (608mm c-c)
3323595 Per pair £16
860mm (800mm c-c)
3323588 Per pair £18</p> | <div data-bbox="1332 822 1675 1346" data-label="Complex-Block"> <p><i>don't forget...</i></p>  <p>Drilling guide
Template with dimensions for drilling handle holes accurately and easily.
3098639 £2.50</p> </div> | |

D-handles

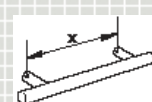
							
<p>Wire 'D' handle</p> <ul style="list-style-type: none"> Brushed nickel finish 3 Sizes <p>138mm (128mm c-c) ▲ 3360903 Per pair £6</p> <p>170mm (160mm c-c) ▲ 3360910 Per pair £7</p> <p>298mm (288mm c-c) 3360927 Per pair £8</p>	<p>'D' handle with foot</p> <ul style="list-style-type: none"> 196mm (160mm c-c) <p>Brushed nickel finish 3342114 Per pair £6</p>	<p>Tool box handle</p> <ul style="list-style-type: none"> 129mm (96mm c-c) <p>Brushed nickel finish ▲ 3175033 Per pair £5</p>	<p>Keyhole handle</p> <ul style="list-style-type: none"> Brushed nickel finish 5 Sizes <p>152mm (128mm c-c) ▲ 3370957 Per pair £9</p> <p>185mm (160mm c-c) ▲ 3232408 Per pair £11</p> <p>313mm (288mm c-c) ▲ 3232422 Per pair £11</p> <p>440mm (416mm c-c) 3370964* Per pair £12</p> <p>475mm (450mm c-c) 3370971* Per pair £14</p> <p>*Available for home delivery only <input type="checkbox"/></p>	<p>Classic 'D' handle</p> <ul style="list-style-type: none"> 160mm (128mm c-c) <p>Brushed nickel finish ▲ 3323168 Per pair £8</p>	<p>Oval pull handle</p> <ul style="list-style-type: none"> 117mm (96mm c-c) <p>Antique silver effect 3882344 Per pair £8</p>	<p>Celtic style handle</p> <ul style="list-style-type: none"> 146mm (128mm c-c) <p>Pewter effect 3342053 Per pair £8</p>	<p>Aluminium bar handle</p> <ul style="list-style-type: none"> 192mm (160mm c-c) <p>Aluminium ▲ 3361023 Per pair £8</p>
							
<p>Splayed foot bar handle</p> <ul style="list-style-type: none"> Brushed black nickel effect 2 Sizes <p>174mm (160mm c-c) 3517635 Per pair £9</p> <p>206mm (192mm c-c) 3517642 Per pair £9</p>	<p>Long pointed 'D' handle</p> <ul style="list-style-type: none"> 241mm (224mm c-c) <p>Matt chrome style 3517659 Per pair £9</p>	<p>Square bar handle</p> <ul style="list-style-type: none"> 168mm (160mm c-c) <p>Brushed nickel finish ▲ 3232439 Per pair £11</p>	<p>Square end 'D' handle</p> <ul style="list-style-type: none"> 174mm (160mm c-c) <p>Pewter effect 3882276 Per pair £11</p>	<p>Oval bar handle</p> <ul style="list-style-type: none"> 204mm (192mm c-c) <p>Brushed nickel finish ▲ 3517628 Per pair £12</p>	<p>Twisted bar handle</p> <ul style="list-style-type: none"> Chrome effect 2 Sizes <p>174mm (160mm c-c) 3882320 Per pair £12</p> <p>340mm (320mm c-c) 3882313 Per pair £16</p>	<p>Flat foot handle</p> <ul style="list-style-type: none"> 178mm (160mm c-c) <p>Brushed nickel finish ▲ 3342121 Per pair £8</p>	<p>Square end 'D' handle</p> <ul style="list-style-type: none"> 220mm (128mm c-c) <p>Nickel effect 3882337 Per pair £10</p>
							
<p>Flat bar handle</p> <ul style="list-style-type: none"> 180mm (160mm c-c) <p>Chrome effect 3882375 Per pair £11</p>	<p>Rectangular pull handle</p> <ul style="list-style-type: none"> 141mm (128mm c-c) <p>Brushed nickel finish 3882382 Per pair £9</p>	<p>Four square bar handle</p> <ul style="list-style-type: none"> 154mm (128mm c-c) <p>Pewter effect 3882252 Per pair £10</p>	<p>Curved handle</p> <ul style="list-style-type: none"> 172mm (160mm c-c) <p>Brushed nickel finish ▲ 3360958 Per pair £9</p>	<p>Slim square bar handle</p> <ul style="list-style-type: none"> Brushed nickel finish 2 Sizes <p>187mm (160mm c-c) 3596593 Per pair £10</p> <p>282mm (256mm c-c) 3596609 Per pair £12</p>	<p>Bar with cuffs handle</p> <ul style="list-style-type: none"> 280mm (224mm c-c) <p>Brushed nickel finish ▲ 3600474 Per pair £11</p>	<p>Half cylinder handle</p> <ul style="list-style-type: none"> 236mm (224mm c-c) <p>Brushed nickel effect 3693636 Per pair £12</p>	<p>Round ended 'D' handle</p> <ul style="list-style-type: none"> 160mm (128mm c-c) <p>Pewter effect 3882351 Per pair £13</p>
				<div data-bbox="913 1077 1275 1332" style="border: 1px solid black; padding: 5px;"> <p><i>don't forget...</i></p>  <p>All handles are sold in pairs. c-c = centre to centre refers to the measurements between each screw on the handle</p> </div>			
<p>Letterbox handle</p> <ul style="list-style-type: none"> 212mm <p>Brushed nickel finish 3892237 Per pair £15</p>	<p>Antique pewter effect 'D' handle</p> <ul style="list-style-type: none"> 160mm (128mm c-c) <p>Antique pewter effect 3882290 Per pair £18</p>	<p>Ceramic drop handle</p> <ul style="list-style-type: none"> 251mm (224mm c-c) <p>Ceramic/antique pewter effect 3090411 Per pair £10</p>	<p>Cage drop handle</p> <ul style="list-style-type: none"> 148mm (128mm c-c) <p>Pewter effect ▲ 5033508 Per pair £10</p>				

Cup handles



take home today

Cup handle
■ 104mm (96mm c-c)

Brushed nickel finish
3175019 Per pair **£7**



take home today

Cup handle
■ 90mm

Antique pewter effect ▲
3438824 Per pair **£8**



Square end cup handle
■ 176mm (96mm c-c)

Pewter effect
3882283 Per pair **£12**



Antique pewter effect cup handle
■ 104mm (64mm c-c)

Pewter effect
3882306 Per pair **£17**

don't forget...

All handles are sold in pairs.
c-c = centre to centre refers to the measurements between each screw on the handle

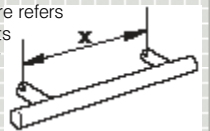

T-bar handles



take home today

Punched pull handle
■ 60mm

Brushed nickel finish
3596487 Per pair **£4**



take home today

Ornate knob & back plate handle
■ 152mm (152mm c-c)

Antique brass finish
5033492 Per pair **£5**



take home today

'T' bar handle
Antique brass finish ▲
5033546 Per pair **£5**



take home today

Cage 'T' bar knob handle
■ 61mm

Antique pewter effect ▲
3361016 Per pair **£6**



take home today

Ceramic 'T' bar handle
■ 60mm

Ceramic/antique pewter effect ▲
3090428 Per pair **£7**

Door knobs



Ceramic knob
■ 45mm

White
5052931385942 Per pair **£4**



take home today

Wooden knob
■ 40mm

Maple effect
5307852 Per pair **£4**

Beech effect ▲
5307869 Per pair **£4**



take home today

Oak knob
■ 43mm

Solid oak ▲
5307876 Per pair **£4**



take home today

Plate handle
■ 31mm

Chrome finish ▲
3039205 Per pair **£5**



take home today

Pyramid knob
■ 30mm

Pewter effect ▲
3360972 Per pair **£6**



take home today

Cage knob
■ 34mm

Pewter effect ▲
5033461 Per pair **£7**



Classic square knob
■ 28mm

Antique pewter effect
3517611 Per pair **£6**



Square handle
■ 80mm

Black
3594940 Per pair **£7**

Red
3594957 Per pair **£7**



take home today

Square knob
■ 45mm

Pewter effect ▲
3435540 Per pair **£7**



Iron knob
■ 44mm

Iron
4011705 Per pair **£9**



take home today

Plug knob
■ 34mm

Antique pewter effect
3342077 Per pair **£7**



Celtic style knob
■ 34mm

Pewter effect ▲
3342060 Per pair **£7**



Oval smooth knob
■ 45mm

Brushed nickel effect
3342107 Per pair **£7**



take home today

Dimpled knob
■ 34mm

Antique pewter effect ▲
3342084 Per pair **£7**



Round knob
■ 44mm

Pewter effect
3882368 Per pair **£9**



Four square knob
■ 38mm

Pewter effect
3882269 Per pair **£9**



take home today

Latch handle
■ H116mm

Antique pewter effect ▲
3438817 Per pair **£9**

don't forget...



Drilling guide

Template with dimensions for drilling handle holes accurately and easily.

3098639 **£2.50**

MADE TO
MEASURE
WORKTOPS

bespoke worktops



Granite
Beautiful natural stone, shaped to fit your kitchen exactly.



Quartz
Man-made granite alternative, templated and cut to your design.



Solid surface
Made-to-measure work surfaces installed to your unique design.

How to order

Discuss your requirements

Discuss your kitchen design requirements with one of our B&Q design consultants in-store or, if you prefer, we will visit you at your home. Our custom worktops are available with fully installed B&Q kitchens, as well as supply only with any B&Q kitchen.

You decide

Select your preferred finish from our display stands and decide on your required profile from our range of options. Design consultants are equipped with display boards for home design appointments. (Display stands for moulded worksurfaces are available in all B&Q Warehouse stores) Once your kitchen plan has been finalised, our design consultant will provide you with a preliminary quote for your custom worktop.

Surveyor visit

Our initial quote is subject to a surveyor site visit. This requires a B&Q surveyor to visit your home to check your kitchen for electrical socket positions, location of window sills etc. Once completed, a final price will be submitted for your approval.

Digital template

Once your new kitchen cabinets have been installed, one of our specialists will visit your home to take a digital template of the worktop area. Your bespoke granite, quartz or solid surface worktop will be made while our kitchen fitters complete the installation of your cabinet furniture.

Installation

Approximately 5 days (10 days for solid surface) after the design of the digital template, our installation team will arrive to install your new worktop. Then, another visit from our kitchen fitters will follow to connect up your taps, sinks and appliances.

Profiles and corners



square edge
profile



double 8mm
radius profile



bullnose 15mm
radius profile

Granite - tough, hard wearing, seamlessly beautiful, our custom made worktops are a fantastically bespoke yet practical choice. (30mm thickness)

Quartz - all the properties of granite with a more consistent composition offering modern design appeal. (30mm thickness).

Solid surface - these are natural effect acrylic stone worksurfaces with a contemporary finish, inconspicuous joints and unique features. (12mm acrylic, 38mm overall thickness).

30mm beautiful natural stone granite worktops are resistant to normal everyday wear and tear. As a natural material, colours and patterns vary piece to piece, making it unique to you.



Colour options

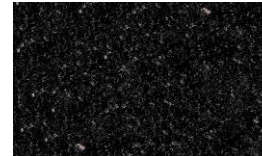

Star galaxy ▲

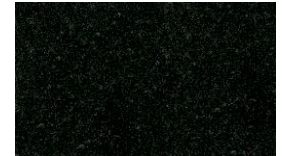

Nero assoluto ▲

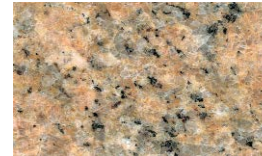

Oro veneziano ▲



Indian black pearl

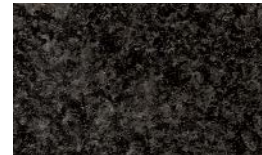

Nero impala

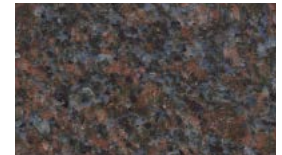

Dakota mahogany



Baltic brown ▲



Emerald black ▲



Bianco sardo ▲



Tan brown

Profile options



square edge profile

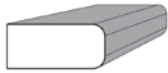

double 8mm radius profile



bullnose 15mm radius profile

MADE TO
MEASURE
WORKTOPS

bespoke quartz

The 30mm quartz range provides a man-made alternative to granite, showing similar properties with consistent colour and pattern.



Profile options



square edge profile

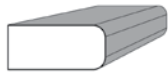

double 8mm radius profile



bullnose 15mm radius profile

Colour options

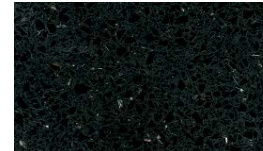

Crystal black ▲



Avalanche



Crystal white ▲



Taupe ▲



Mixed grey ▲



Nevada sand ▲

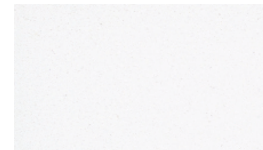

Pure white

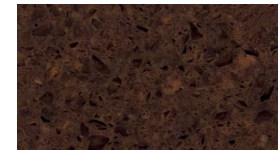

Comet brown ▲



Marbled white



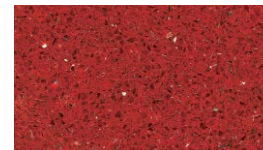

Marbled almond

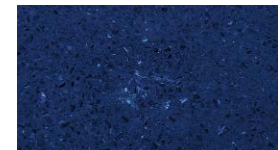

Red quartz



Blue quartz

how to shop •  in-store •  online www.diy.com •  phone 0870 0101 006

Combines the natural beauty and durability of stone with the consistency of an engineered work surface. 38mm made-to-measure to create a wide range of individual pieces.



Colour options

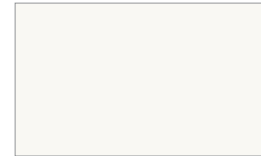

Alpine white ▲

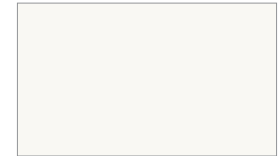

Arctic granite

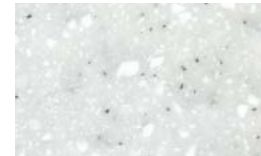

White quartz ▲



Tambora ▲



Peanut butter ▲



Grey sand ▲

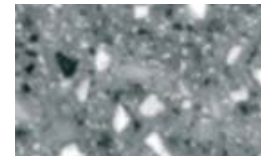

Grey granite



Allspice quartz



Nebula



Black sand ▲

Profile options



square edge profile

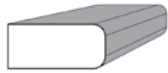

double 8mm radius profile



bullnose 15mm radius profile



HI-MACS®
Natural Acrylic Stone™

Introducing Cooke & Lewis Gemstone, a new, enchanting kitchen worksurface range that's as hard as Quartz, as beautiful as Granite and as easy to install as Earthstone!



don't forget...

Installation kit ▲	
5397007122268	£68
Maintenance kit ▲	
5397007122282	£68

what's it made of?

A 6mm solid material bonded to a 28mm high performance chipboard core, Cooke & Lewis Gemstone is the perfect green choice, formulated with 85% recycled material.

Profile options

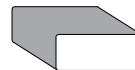

3mm profile
a lightly rounded edge for an almost square appearance

	Permian	Triassic
worktop W1500 x D605 x H34mm	£364 5397007119152	£364 5397007119046
worktop W3050 x D605 x H34mm	£582 5397007119145	£582 5397007119039
breakfast bar W1500 x D970 x H34mm	£578 5397007118803	£578 5397007119060
breakfast bar W3050 x D665 x H34mm	£674 5397007118797	£674 5397007119053
worktop with sink and right hand drainer W1500 x D605 x H34mm	£972 5397007118810	£972 5397007119077
worktop with sink and left hand drainer W1500 x D605 x H34mm	£972 5397007118827	£972 5397007119084
upstand W1500 x D50 x H12mm	£95 5397007118841	£95 5397007119107
splashback W1500 x D450 x H6mm	£187 5397007118858	£187 5397007119114
hob back panel W760 x D610 x H6mm	£187 5397007118865	£187 5397007119121
edging straight W980 x D38 x H6mm	£14 5397007118872	£14 5397007119138
colour-matched adhesive	£32 3880272	£32 5397007129427
breakfront worktop W3050 x D605 x H34mm	£694 5397007118834	£694 5397007119091
Edging curved W800 x D38 x H6mm	£95 4172666	£95 4172659

Note: Gemstone worksurfaces are fitted in a similar way to Earthstone, but require high quality Polycrystalline Diamond cutters and Grooves. For a perfect fit ask our installation Team for help.

▲ Our Banbury, Bedford, Burgess Hill, Bognor Regis, Consett, Eastleigh, Fareham, Hedge End, Nursing, Poole, Portsmouth, Port Glasgow and Sydenham stores stock a wide range of products – all available to take away. The Symbol is used throughout this Buying Guide to indicate the products that these stores stock. However these are subject to availability and ranges may vary by store.

An innovation in kitchen work surfaces, 34mm thick Earthstone effectively bridges the gap between granite and laminate.



don't forget...

counter top magic 70048114151	£17
Solid surface installation kit 3880838	£67

Profile options

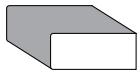

3mm profile
a lightly rounded edge for an almost square appearance

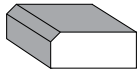

Bevel edge
a brand new distinctive premium edge

Nova Undermount jig	5397007122329	£37	📏
C&L Nitoite sq undermount 1b sink jig	W1000 x D600 x H12mm	4078807	£37
C&L Nitoite sq undermount 1½b sink jig	W1000 x D600 x H12mm	4078821	£37
C&L Nitoite drainer tray	W1000 x D600 x H12mm	4078814	£37
Franke Compact u/mount cpx160p sink jig	W1000 x D600 x H12mm	4078838	£37
Franke Peak PkX110 undermount 1b sink jig	W1000 x D600 x H12mm	4078845	£37
Isabella undermount 1½b combined sink jig	W1000 x D600 x H12mm	3893852	£37
Isabella 1 and ½ separate bowl jig	W1000 x D600 x H12mm	3893869	£37
Curved edge worktop jig	W1000 x D600 x H12mm	3893883	£20
Drainer groove jig	W600 x D500 x H12mm	3893890	£37
Pinta undermount jig	W600 x D500 x H12mm	3893845	£37

	Scorpio Bevel edge	Libra Bevel edge	Gemini Bevel edge	Gold dust 3mm profile	Black star 3mm profile	Coffee 3mm profile	Pastel 3mm profile	Nordic 3mm profile	Glacier 3mm profile
worktop W1800 x D605 x H34mm	£304 5397007118704	£304 5397007118926	£304 5397007118582	£304 3897119	£304 3885956 3880173	£304 3879948 3880173	£304 3879948 3880173	£304 3886120 3880432	£304 3880432 3880432
worktop W3000 x D605 x H34mm	£532 5397007118698	£532 5397007118919	£532 5397007118179	£532 3897102	£532 3885871 3880166	£532 3879931 3880166	£532 3879931 3880166	£532 3886113 3880425	£532 3880425 3880425
breakfast bar W1800 x D970 x H34mm	£493 5397007118728	£493 5397007118940	£493 5397007118605	£493 3897133	£493 3885994 3880197	£493 3879962 3880197	£493 3879962 3880197	£493 3886144 3880456	£493 3880456 3880456
breakfast bar W3000 x D605 x H34mm	£582 5397007118711	£582 5397007118933	£582 5397007118599	£582 3897126	£582 3885970 3880180	£582 3879955 3880180	£582 3879955 3880180	£582 3886137 3880449	£582 3880449 3880449
worktop with sink and right hand drainer W1800 x D605 x H34mm	£968 5397007118735	£968 5397007118957	£968 5397007118612	£968 3897157	£968 3886038 3880210	£968 3879986 3880210	£968 3879986 3880210	£968 3886168 3880470	£968 3880470 3880470
worktop with sink and left hand drainer W1800 x D605 x H34mm	£968 5397007118742	£968 5397007118964	£968 5397007118629	£968 3897225	£968 3886106 3880289	£968 3879986 3880289	£968 3879986 3880289	£968 3886236 3880548	£968 3880548 3880548
upstand W1800 x D50 x H12mm	£74 5397007118766	£74 5397007118988	£74 5397007118643	£74 3897164	£74 3886045 3880227	£74 3879993 3880227	£74 3879993 3880227	£74 3886175 3880487	£74 3880487 3880487
splashback W1800 x D450 x H6mm	£195 5397007118773	£195 5397007118995	£195 5397007118650	£195 3897171	£195 3886052 3880234	£195 3879993 3880234	£195 3879993 3880234	£195 3886182 3880494	£195 3880494 3880494
hob back panel W610 x D760 x H6mm	£167 5397007118889	£167 5397007119008	£167 5397007118667	£167 3897188	£167 3886069 3880241	£167 3879993 3880241	£167 3879993 3880241	£167 3886199 3880500	£167 3880500 3880500
edging straight W980 x D38 x H6mm	£12 5397007118896	£12 5397007119015	£12 5397007118674	£12 3897195	£12 3886076 3880258	£12 3879993 3880258	£12 3879993 3880258	£12 3886205 3880517	£12 3880517 3880517
edging curved W800 x D38 x H6mm	£53 5397007118902	£53 5397007119022	£53 5397007118681	£53 3897201	£53 3886083 3880265	£53 3879993 3880265	£53 3879993 3880265	£53 3886212 3880524	£53 3880524 3880524
colour-matched adhesive	£32 5397007122305	£32 3886090	£32 5397007129403	£32 3897218	£32 3886090 3880272	£32 3879993 3880272	£32 3879993 3880272	£32 3886229 3880531	£32 3880531 3880531
backfront worktop W3000 x D605 x H34mm	£627 5397007118759	£627 5397007118971	£627 5397007118636	£627 3897140	£627 3886014 3880203	£627 3879993 3880203	£627 3879993 3880203	£627 3886151 3880463	£627 3880463 3880463
Corner section W950 x D950 x H34mm	£698 4164708	£698 4164722	£698 4164715	£598 4164739	£568 4164746	£568 4164753	£568 4164760	£568 4164777	£568 4164784

FINISHING TOUCHES

solid wood worktops

Timeless beauty, warmth and character shines through our premium FSC accredited solid wood worktops. 40mm* thick and with an ultra smooth surface, our real wood range is pre-oiled to give maximum protection against moisture and stains.

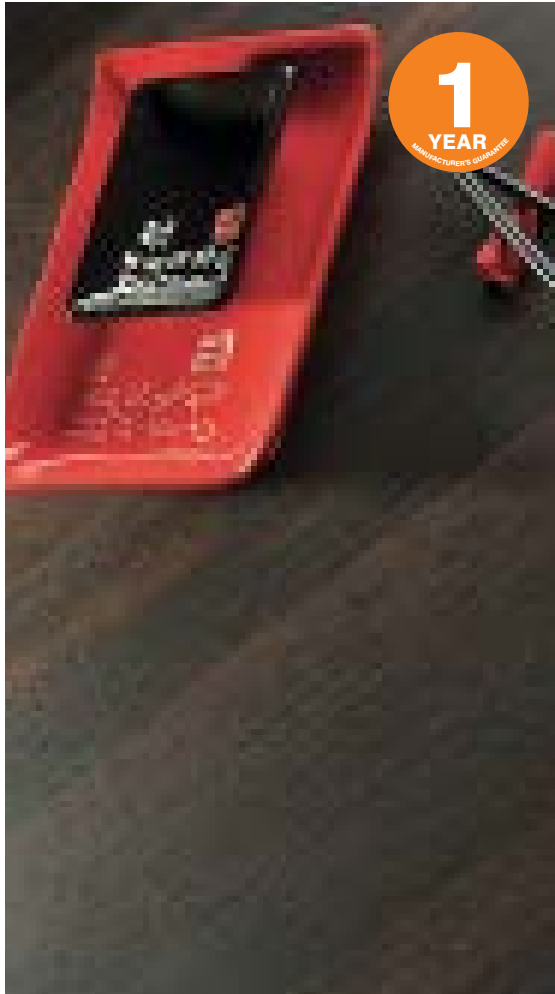

	Wenge	Walnut	Oak	Birch	Beech	Bamboo
worktop W3000 x D600 x H27mm	-	-	£213 5052931116980	-	£87 3881026	-
worktop W3000 x D600 x H40mm	£505 5052931117246	£407 5052931117185	£298 5052931116997	£182 4167549	£274 5052931116911	£302 4167501
breakfast bar W3000 x D665 x H40mm	£532 5052931117253	£458 5052931117192	£274 5052931117000	£198 4167556	£295 5052931116928	£324 4167518
island unit W1800 x D970 x H40mm	£478 5052931117260	£407 5052931117208	£263 5052931117017	£193 4167563	£284 5052931116935	£315 4167525
upstand W3000 x D20 x H40mm	£50 5052931117284	£37 5052931117222	£28 5052931117055	£23 4167570	£32 5052931116973	£28 4167532
breakfront worktop W3000 x D600 x H40mm (D675 at widest point)	£554 5052931117277	£475 5052931117215	£324 5052931117024	-	£307 5052931116942	-

Drawings are for illustrative purposes only.

don't forget...

Solid wood installation kit 3411704	£94
Solid wood sealant 3442319	£25

what's it made of?

Solid wood through and through, with finger-jointed staves and kiln dried to 8% moisture content.

Responsibly sourced from sustainable forests

Behind the scenes at B&Q, you'll find 20 years of experience in ensuring that all our timber is from sustainably managed forests

*Beech and oak also available 27mm thick

▲ Our Banbury, Bedford, Burgess Hill, Bognor Regis, Consett, Eastleigh, Fareham, Hedge End, Nursing, Poole, Portsmouth, Port Glasgow and Sydenham stores stock a wide range of products – all available to take away. The symbol is used throughout this Buying Guide to indicate the products that these stores stock. However these are subject to availability and ranges may vary by store.

how to shop • in-store • online www.diy.com • phone 0870 0101 006

Solid wood worktops



White cashmere (etched) 38mm round edge

Lamininate worktops offer an array of decors including brand new designs and textures with unbeatable durability at an affordable price, ideal for any kitchen design

Features & benefits

- **Affordable**
Suitable for every budget
- **Durable**
For long lasting surface performance
- **Simple to Install**
Reducing fitting time and cost
- **Vast design range**
Offering a design choice to suit all kitchens

Profile options

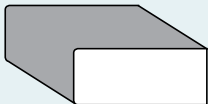

Square edge (28mm, 38mm or 50mm)

A fully square profile offering the most striking, contemporary design

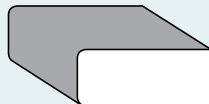

6mm profile (38mm)

A tighter edge radius accomplishing a more modern design

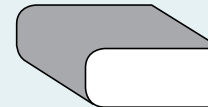

10mm profile (28mm or 38mm)

A rounded front edge typically creating a traditional design



Aeon

Available in 4 superb decor choices there is no compromising style for performance when you select a worktop manufactured with Aeon technology. These decors offer 3-5x the wear resistance of a standard laminate, ensuring superior performance in everyday use.

Square edge profile (28mm, 38mm or 50mm)

The perfect choice to create a contemporary, bold statement, laminate square edge worktops are available in 3 thicknesses to suit any kitchen design.

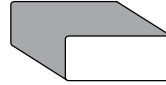

Square edge (28mm, 38mm or 50mm)

A fully square profile offering the most striking, contemporary design

28mm square-edge



Cracked glass gloss
ABS edge

	laminate worktop W3000 x D600 x H28mm	£125 3701980	
	laminate worktop W3600 x D600 x H38mm	-	
	breakfast bar W2000 x D900 x H28mm	£165 3701997	
	breakfast bar W3000 x D665 x H38mm	-	
	upstand W3050 x D12 x H70mm	£25 3702000	
	splashback W3050 x D9 x H600mm	-	
	corner joint W20 x D630 x H40mm	-	
	butt joint W16 x D630 x H42mm	-	
	end cap W6 x D630 x H41mm	-	
	laminate strip W3000 x H42mm	£22 3702284	
	colorfill 25 grams	-	

38mm square-edge

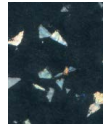

Astral black gloss



Astral white gloss

	laminate worktop W3000 x D600 x H38mm	£138 3885697	£138 3885659
	laminate worktop W3600 x D600 x H38mm	-	-
	breakfast bar W2000 x D900 x H38mm	£178 3885710	£178 3885673
	breakfast bar W3000 x D665 x H38mm	£188 3885703	£188 3885666
	upstand W3050 x D12 x H70mm	£30 4019893	£30 4019886
	splashback W3050 x D9 x H600mm	-	-
	corner joint W20 x D630 x H40mm	-	-
	butt joint W16 x D630 x H42mm	-	-
	end cap W6 x D630 x H41mm	-	-
	laminate strip W3000 x H42mm	£12 3885727	£12 3885680
	colorfill 25 grams	£8 3503997	£8 3375457

50mm square-edge (extra thick)

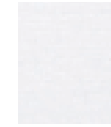

Designer White (Aeon)

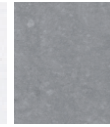

Tectonica



Designer Black (Aeon)



Cypress Cinnamon

	laminate worktop W3000 x D600 x H50mm	£152 5397007104189	£152 5397007104226	£152 5397007121308	£152 5397007122183
	breakfast bar W2000 x D900 x H50mm	£192 5397007104196	£192 5397007104233	£192 5397007121322	£192 5397007122206
	upstand W3050 x D12 x H70mm	£25 5397007104202	£25 5397007104257	£25 5397007121346	£25 5397007122220
	laminate strip W3000 x H54mm	£12 5397007104219	£12 5397007104240	£12 5397007121360	£12 5397007122244
	colorfill 25 grams	£8 3375457	£8 4138730	£8 3503997	£8 3590157



Astral black gloss 38mm square edge

Laminate worktops

Round edge profile (28mm or 38mm)

A stunning range of designs with a classic edge profile benefiting from a full laminate wrap round for increased water resistance.

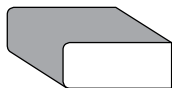

6mm profile (38mm)

A tighter edge radius accomplishing a more modern design

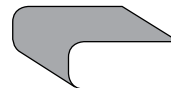





10mm profile (28mm or 38mm)

A rounded front edge typically creating a traditional design



















28mm laminates

(10mm profile)

	 10mm	 10mm	 10mm
	Beech	White	Inari Granite
 laminate worktop W3050 x D600 x H28mm	£40 3714997 ▲	£40 3714980 ▲	£40 3711606 ▲
 corner joint (silver effect) W19 x D630 x H30mm	£5 3723722 ▲	£5 3723722 ▲	£5 3723722 ▲
 butt joint (silver effect) W16 x D630 x H32mm	£5 3723708 ▲	£5 3723708 ▲	£5 3723708 ▲
 end cap (silver effect) W6 x D630 x H31mm	£5 3723715 ▲	£5 3723715 ▲	£5 3723715 ▲
 laminate strip W3000 x H32mm	£5 3713167 ▲	£5 3713143 ▲	£5 3713174 ▲
 colorfill 25 grams	£8 3287439 ▲	£8 3504017 ▲	£8 3150672 ▲

38mm laminates

(6mm/10mm profile)

	 6mm	 6mm	 6mm	 6mm	 6mm	 6mm	 10mm	 6mm
	Romantic walnut	Oak woodmix	Light cherry block	Beech block	Walnut butcher's block	Oak	Beech butcher's block*	White cashmere etched
 laminate worktop W3000 x D600 x H38mm	£88 3701737 ▲	£73 3376256 ▲	£72 3502808 ▲	£85 3356012 ▲	£82 3502877 ▲	£87 4075103 ▲	£62 3283813 ▲	£104 3699980 ▲
 laminate worktop W3600 x D600 x H38mm	£105 3701744 ▲	-	-	-	£118 3376324 ▲	£118 4075110 ▲	-	£138 3699997 ▲
 breakfast bar W2000 x D900 x H38mm	£145 3701768 ▲	£135 3376362 ▲	£145 3376447 ▲	£135 3358702 ▲	£135 3376454 ▲	£135 4075127 ▲	-	£155 3700303 ▲
 breakfast bar W3000 x D665 x H38mm	£155 3701751 ▲	£145 3613825 ▲	-	-	£145 3376553 ▲	£145 4075134 ▲	-	£165 3700310 ▲
 upstand W3050 x D12 x H70mm	£25 3701775 ▲	£25 3377468 ▲	£25 3377635 ▲	£25 3377437 ▲	£25 3377642 ▲	£25 4085904 ▲	-	£25 3713990 ▲
 splashback W3050 x D9 x H600mm	-	-	-	-	-	-	-	£92 3713877 ▲
 corner joint W20 x D630 x H40mm	£8 3372869 ▲	£8 3372869 ▲	£8 3375204 ▲	£8 3375204 ▲	£8 3503966 ▲	£8 3375204 ▲	£8 3287484 ▲	£8 3590591 ▲
 butt joint W16 x D630 x H42mm	£8 3372883 ▲	£8 3372883 ▲	£8 3375426 ▲	£8 3375426 ▲	£8 3503959 ▲	£8 3375426 ▲	£8 3288054 ▲	£8 3590898 ▲
 end cap W6 x D630 x H41mm	£8 3372876 ▲	£8 3372876 ▲	£8 3375310 ▲	£8 3375310 ▲	£8 3503942 ▲	£8 3375310 ▲	£8 3288016 ▲	£8 3590850 ▲
 laminate strip W3000 x H42mm	£12 3713914 ▲	£12 3376850 ▲	£12 3376942 ▲	£12 3376829 ▲	£12 3376959 ▲	£12 4089032 ▲	£12 3376713 ▲	£12 3713198 ▲
 colorfill 25 grams	£8 3504178 ▲	£8 3372951 ▲	£8 3375532 ▲	£8 3287439 ▲	£8 3375549 ▲	£8 3372951 ▲	£8 3287439 ▲	£8 3504017 ▲

Drawings are for illustrative purposes only. *10mm round edge laminate. All other worktops have a 6mm squarer profile.

38mm laminates (6mm/10mm profile)

	10mm	10mm	10mm	6mm	6mm	10mm	6mm	6mm	6mm	6mm	6mm	6mm	10mm	6mm	6mm	6mm	6mm
	Black quartz gloss*	Ebony granite satin*	Slate style*	Jamocho gloss	Butterum etched textured	Venice granite satin*	Travertine beige gloss	Cappuccino stone textured*	Valencia satin	Midnight granite gloss	Midnight granite satin	Avalon black textured	Ebony granite gloss*	Chalk travertine	Basalt slate textured	Lunar Night Aeon	Bella noche Aeon
laminare worktop W3000 x D600 x H38mm	£78 3261200	£68 3308219	£65 3324561	£85 3701836	£107 3501993	£74 3502815	£82 3502112	£98 3899557	£54 3896332	£84 3714683	£67 3701935	£105 3502150	£84 3260111	£93 4075141	£98 3502235	£117 3885505	£125 3885550
laminare worktop W3600 x D600 x H38mm	-	£82 3623718	-	£112 3701843	£128 3502006	-	£112 3502129	£132 3899564	£84 3899649	£112 3714690	£92 3701942	£135 3502167	£112 3384336	£132 4075158	£132 3502242	-	-
breakfast bar W2000 x D900 x H38mm	£118 3261217	£108 3308202	-	£125 3701867	£147 3502013	£114 3502822	£122 3502136	£138 3899571	£102 3899656	£124 3714751	£107 3701966	£145 3502174	£124 3260128	£133 4075165	£138 3502259	£157 3885529	£165 3885574
breakfast bar W3000 x D665 x H38mm	-	£118 3613832	-	£135 3701850	£157 3612613	£124 3613818	£132 3612620	£148 3899588	£112 3899663	£134 3714720	£117 3701959	£155 3612637	£134 3628010	£143 4075172	£148 3612644	£167 3885512	£175 3885567
upstand W3050 x D12 x H70mm	£25 3261248	£25 3312469	-	£25 3701874	£25 3503317	£25 3502839	£25 3503348	£25 4019862	£25 5330070/40387	£25 3714782	£25 3701973	£25 3503331	£25 3261279	£25 4085911	£25 3503300	£25 3885536	£25 3885581
splashback W3050 x D9 x H600mm	£92 3702468	£92 3702482	-	£92 3702376	-	-	-	-	-	£92 3714812	£92 3702406	£92 3702444	£92 3702475	-	£92 3702451	-	-
corner joint W20 x D630 x H40mm	£8 3503683	£8 3335055	£8 3503683	£8 3503904	£8 3372869	£8 3503713	£8 3372869	£8 3503904	£8 4016700	£8 3503874	£8 3503874	£8 3503874	£8 3335055	£8 3590591	£8 3503874	£8 4016700	£8 3503966
butt joint W16 x D630 x H42mm	£8 3503676	£8 3336670	£8 3503676	£8 3503898	£8 3372883	£8 3503706	£8 3372883	£8 3503898	£8 4016724	£8 3503867	£8 3503867	£8 3503867	£8 3336670	£8 3590898	£8 3503867	£8 4016724	£8 3503959
end cap W6 x D630 x H41mm	£8 3503669	£8 3336663	£8 3503669	£8 3503881	£8 3372876	£8 3503690	£8 3372876	£8 3503881	£8 4016717	£8 3503850	£8 3503850	£8 3503850	£8 3336663	£8 3590850	£8 3503850	£8 4016717	£8 3503942
laminare strip W3000 x H42mm	£12 3376782	£12 3376775	£12 3376720	£12 3702253	£12 3503218	£12 3503379	£12 3503249	£12 4019824	£12 4008408	£12 3714799	£12 3702277	£12 3503164	£12 3376768	£12 4089001	£12 3503188	£12 3885543	£12 3885598
colorfill 25 grams	£8 3504024	£8 3311912	£8 3336687	£8 3590157	£8 3504178	£8 3504178	£8 3503980	£8 3590157	£8 3311912	£8 3375518	£8 3311912	£8 3503997	£8 3263105	£8 3504017	£8 3504000	£8 3311912	£8 3375549

Drawings are for illustrative purposes only. *10mm round edge laminate. All other worktops have a 6mm squarer profile. Selected Stores

Curved laminate worktops

Curved laminate worktops are finished on three sides.

	Ebony granite gloss ABS edge	Ebony granite satin ABS edge
wall run left W1800 x D600 x H38mm	£142 3715369	£142 3715420
wall run right W1800 x D600 x H38mm	£142 3715376	£142 3715437
laminare strips W1500 x D42mm	£22 3742839	£22 3742846

ABS edging provides an acrylic, high impact resistant, flat edge profile finish. The edge is colour-matched to the worktop.

	For use with 10mm laminates		For use with 6mm laminates	
	Silver effect	Stainless steel	Silver effect	Stainless steel
corner joint W20 x D630 x H40mm	£8 3101575	£8 3360644	£8 3590775	£8 3590768
butt joint W16 x D630 x H42mm	£8 3101735	£8 3360651	£8 3590911	£8 3590904
end cap W6 x D630 x H41mm	£8 3101582	£8 3360637	£8 3590874	£8 3590867

Drawings are for illustrative purposes only.

The stainless steel and silver effect accessories are compatible with any 10mm or 6mm square edge 38mm laminate. These accessories offer an alternative to the colour-matched option.



Adhesive heat reflective tape

- To protect worktops

50mm x 3m 3360705 **£8**



Adhesive heat reflective sheet

- To protect worktops

1m x 600mm 3360712 **£8**



Worktop installation kit

- Includes:
 - 3 x 150mm connecting bolts
 - 3 x jointing biscuits
 - 23g tube of silicon sealant

3360668 **£8**



Colorfill

- Various colours

25 Grams **£8**



Contact adhesive

- For fixing laminate edging

80 Grams 3604199 **£6**



Worktop connecting bolts

- Pack of 3
- 150mm

3536278 **£5**



Worktop support leg

- Ideal for breakfast bars

Chrome effect 3411216 **£23**
 Stainless steel effect 3411223 **£23**



Pop-up worktop socket

3882597 **£45**



6 Hot rod worktop protectors

5217687 **£12**



Gloss surface cleaner

3868775 **£8**



Mitre pen

3536285 **£10**



Plinthlock panellock

3868751 **£10**



Fitter's worktop connecting bolts

3360729 **£13**



Fitter's worktop biscuits

3360682 **£4**



Vistelle acrylic splashbacks*

The award winning and innovative high gloss acrylic panel perfect for transforming your kitchen. An easy alternative to tiling.

- Luxurious and elegant glass effect finish
- No templating, can be cut and drilled on site
- Half the weight and greater scratch resistance than glass
- Simple to install using double sided tape and neutral cure silicone
- Easy to maintain

*Not to be used within 50mm of a gas hob

Edge profiles for acrylic splashbacks

Matt aluminium
1250mm length

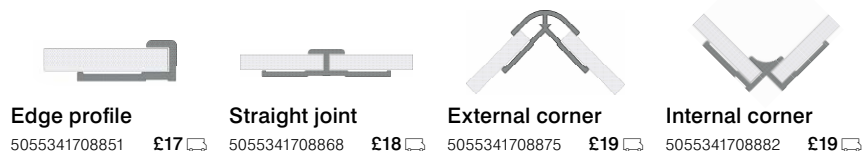

Edge profile

5055341708851 £17

Straight joint

5055341708868 £18

External corner

5055341708875 £19

Internal corner

5055341708882 £19



Always use a heat resistant glass splashback behind a gas hob

Glass splashbacks

A stylish and simple solution for use in conjunction with a gas hob.

- Co-ordinates with Vistelle acrylic splashbacks
- Simple to install with self-adhesive pads
- Heat resistant
- Suitable for 60cm gas hob

Acrylic and glass colour options



White

■ Acrylic
H760 x W700 x D4mm
5055341708790 £128

H500 x W2070 x D4mm
5055341708738 £158

■ Glass
H760 x W700 x D4mm
5397007107586 £77



Glacier

■ Acrylic
H760 x W700 x D4mm
5055341708806 £128

H500 x W2070 x D4mm
5055341708745 £158

■ Glass
H760 x W700 x D4mm
5397007107609 £77



Red

■ Acrylic
H760 x W700 x D4mm
5055341708813 £128

H500 x W2070 x D4mm
5055341708752 £158

■ Glass
H760 x W700 x D4mm
5397007107623 £77



Mocha

■ Acrylic
H760 x W700 x D4mm
5055341708820 £128

H500 x W2070 x D4mm
5055341708769 £158

■ Glass
H760 x W700 x D4mm
5397007107647 £77

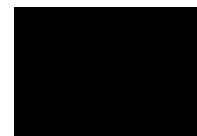

Black

■ Acrylic
H760 x W700 x D4mm
5055341708837 £128

H500 x W2070 x D4mm
5055341708776 £158

■ Glass
H760 x W700 x D4mm
5397007107661 £77



Grey

■ Acrylic
H760 x W700 x D4mm
5055341708844 £128

H500 x W2070 x D4mm
5055341708783 £158

■ Glass
H760 x W700 x D4mm
5397007107685 £77



Blue Atoll

■ Acrylic
H760 x W700 x D4mm
5055341709162 £128

H500 x W2070 x D4mm
5055341709155 £158

■ Glass
H760 x W700 x D4mm
5397007122541 £77

don't forget

Vistelle™ installation kit

Including neutral cure silicon, tape, sanding pad and spacers - one install kit for up to 2 panels

5055341708899 £30

For more technical help call our Vistelle specialists on **0845 058 0727**

or go to www.aquadry.com

Calls charged at national rate.

Acrylic and glass colour options

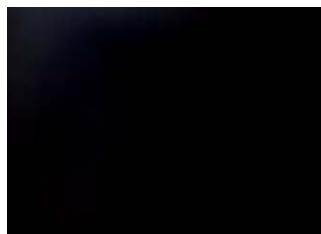

Black



H750 x W600 x D6mm
5397007146806

£80



Cappuccino



H750 x W600 x D6mm
5397007146813

£80



Red



H750 x W600 x D6mm
5397007146820

£80



Black and white
floating seed



H750 x W600 x D6mm
5397007122527

£85



Aubergine



H750 x W600 x D6mm
5397007146837

£80



Pink



H750 x W600 x D6mm
5397007146844

£80



Green



H750 x W600 x D6mm
5397007146851

£80



Esmerelda



H750 x W600 x D6mm
5397007122145

£80



Alep



H750 x W600 x D6mm
5397007122169

£80



Smoke



H750 x W600 x D6mm
5397007122480

£80



Anthracite



H750 x W600 x D6mm
5397007122503

£80



Black floral pattern



H750 x W600 x D6mm
5397007146790

£85

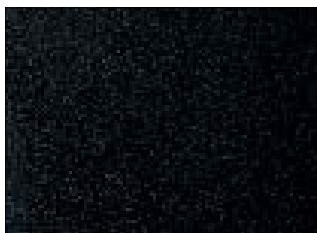

Black pearl
(with shimmer)



H750 x W600 x D6mm
5397007146783

£85

don't
forget...

You can choose from a wide range of laminate splashbacks to match our laminate worktops.



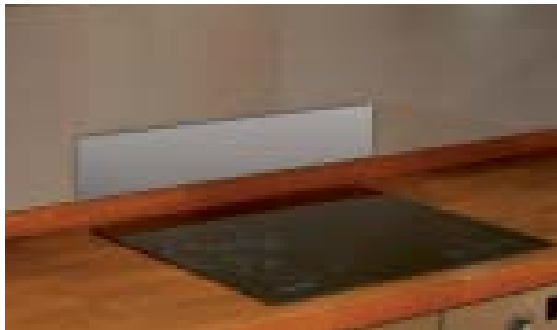

Aluminium splashback

Recommended for use directly behind electric and induction hobs.

H200 x W700 x D4mm 5055341708905 **£34** 



Clear and frosted glass splashbacks

Clear glass

H750 x W600 x D6mm 5291823 **£40**  ▲

H900 x W750 x D6mm 5291830 **£45**  ▲

Frosted glass

H750 x W600 x D6mm 5291847 **£50**  ▲

H900 x W750 x D6mm 5291854 **£55**  ▲



Stainless steel effect splashbacks

H750 x W600 x D6mm 3232040 **£40**  ▲

H750 x W700 x D6mm 3429648 **£52**  ▲

H750 x W900 x D6mm 3234907 **£80**  ▲

FINISHING TOUCHES | bar stools



Dante bar stool ▲

■ W41 x D41 x H66-87cm

■ PVC and chrome effect

Black 5052931076147 **£27**

White 5052931076154 **£27**



Tess bar stool ▲

■ W41 x D41 x H70-85cm

■ Chrome effect

White / grey 3454975930287 **£37**

White / red 3454975930294 **£37**

▲ Our Banbury, Bedford, Burgess Hill, Bognor Regis, Consett, Eastleigh, Fareham, Hedge End, Nursing, Poole, Portsmouth, Port Glasgow and Sydenham stores stock a wide range of products – all available to take away. The Symbol is used throughout this Buying Guide to indicate the products that these stores stock. However these are subject to availability and ranges may vary by store.

We have a comprehensive range of sinks to choose from so you will be spoilt for choice with professional stainless steel designs, traditional ceramic styles and state-of-the-art composite materials in a variety of shapes and sizes. They are all manufactured to the highest specifications and are guaranteed to stand up to the demands of busy kitchen life.

Utility sinks



Utility inset single bowl

Overall dimensions: L935 x W485 x D160mm
 Bowl size: L400 x W340 x D160mm
 Cut-out size: L915 x W465mm
 Minimum cabinet size: 500mm
 ■ Sealing strip and fixing clips included
 ■ Waste not included – pack A waste kit and overflow required

Stainless steel	Right hand drainer	5011818033710	£30
Stainless steel	Left hand drainer	5011818033703	£30



Utility inset reversible single bowl

Overall dimensions: L935 x W485 x D160mm
 Bowl size: L400 x W340 x D160mm
 Cut-out size: L915 x W465mm
 Minimum cabinet size: 500mm
 ■ Sealing strip and fixing clips included
 ■ Waste not included – pack A waste kit and overflow required
 ■ Reversible drainer

Stainless steel		5011818033987	£44
-----------------	--	---------------	-----



Utility sit-on single bowl

Overall dimensions: L1000 x W600 x D170mm
 Bowl size: L400 x W400 x D170mm
 Cut-out size: Sit-on
 Minimum cabinet size: 1000mm
 ■ Waste not included – pack A waste kit and overflow required

Stainless steel	Right hand drainer	5011818033734	£65
Stainless steel	Left hand drainer	5011818033727	£65

Kitchen sinks



Sunrise round bowl

Overall dimensions: L900 x W480 x D156mm
 Bowl size: 380mm diameter (D175mm)
 Cut-out size: L880 x W460mm
 Minimum cabinet size: 450mm
 ■ Reversible drainer
 ■ Fixings included
 ■ Optional accessory pack available (see Cascade accessory pack)
 ■ Waste not included – pack C waste kit and pack E overflow required

Stainless steel		5016203763937	£48
Next day delivery		5016203792135	£62**



Toga 45S Compact 1.0 Bowl Sink

Overall dimensions: L780 x W500 x D160mm
 Bowl size: L345 x W420 x D160mm
 Cut-out size: L762 x W482mm
 Minimum cabinet size: 450mm
 ■ Reversible drainer
 ■ Waste not included – pack 3 waste kit and overflow required
 ■ Factory fitted seal and fixing clips

Stainless steel		4020684619561	£50
-----------------	--	---------------	-----



Sunrise 800mm compact / 965mm single bowl

Overall dimensions: L800 or L965 x W500 x D155mm
 Bowl size: L340 or L400 x W400 x D155mm
 Cut-out size: L780 or L945 x W480mm
 Minimum cabinet size: 450mm or 500mm
 ■ Sealing strip and fixing clips included
 ■ Waste not included – pack C waste kit and pack E overflow required
 ■ Reversible drainer
 ■ 800mm Compatible with accessories: C, D
 ■ 965mm Compatible with accessories: B, D

800mm	Stainless steel	5016182179552	£58
800mm	Next day delivery	5016203791749	£72**
965mm	Stainless steel	5016182179569	£58
965mm	Next day delivery	5016203791763	£72**



Sunrise 1½ bowl

Overall dimensions: L965 x W500 x D155mm
 Bowl size: L340 x W400 x D155mm
 ½ Bowl size: L160 x W300 x D86mm
 Cut-out size: L945 x W480mm
 Minimum cabinet size: 600mm
 ■ Sealing strip and fixing clips included
 ■ Waste not included – 2 x pack C waste kits required
 ■ Reversible drainer
 ■ Compatible with accessories: A, C, D

Stainless steel		5016182179576	£70
Next day delivery		5016203791770	£90**



Toga single bowl

Overall dimensions: L860 x W500 x D160mm
 Bowl size: L345 x W420 x D160mm
 Cut-out size: L842 x W482mm
 Minimum cabinet size: 450mm
 ■ Reversible drainer
 ■ Waste not included – pack 3 waste kit and overflow required
 ■ Factory fitted seal and fixing clips

Stainless steel		4020684578363	£70
Next day delivery		5035889074663	£80**

Taps not included
 *£5 delivery also applies
 **includes waste kit

All guarantees are manufacturer guarantees. This does not affect your legal rights.

Turn to page 69 for accessories

BLANCO
GERMANY

Compatible with waste disposal unit

50
YEAR
MANUFACTURER'S GUARANTEE



Toga 1½ bowl □

Overall dimensions: L950 x W500 x D160mm
Bowl size: L335 x W400 x D160mm
½ Bowl size: L180 x W320 x D90mm
Cut-out size: L932 x W482mm
Minimum cabinet size: 600mm
■ Reversible drainer
■ Waste not included – pack 2 waste kit and overflow required
■ Factory fitted seal and fixing clips

Stainless steel	4020684578370	£97
Next day delivery	5035889074670	£115**

COOKE
&LEWIS

LIFE TIME
MANUFACTURER'S GUARANTEE



Compatible with waste disposal unit

Tanzan single bowl □ ▲

Overall dimensions: L965 x W500 x D171mm
Bowl size: L410 x W350 x D171mm
Cut-out size: L945 x W480mm (corner radius 55mm)
Minimum cabinet size: 500mm
■ Reversible drainer
■ Waste not included – pack C waste kit and pack E overflow required
■ Compatible with accessories: **D N**

Polished steel	4069522	£93
Next day delivery	5016203792142	£107**

COOKE
&LEWIS

LIFE TIME
MANUFACTURER'S GUARANTEE



Tanzan 1½ bowl □ ▲

Overall dimensions: L965 x W500 x D171mm
Bowl size: L410 x W350 x D171mm
½ Bowl size: L163 x W302 x D121mm
Cut-out size: L945 x W480mm (corner radius 55mm)
Minimum cabinet size: 600mm
■ Reversible drainer
■ Waste not included – 2 x pack C waste kits required
■ Compatible with accessories: **D M N**

Polished steel	4069539	£112
Next day delivery	5016203792159	£132**



5
YEAR
MANUFACTURER'S GUARANTEE

Save **£29** when bought as a package with Cascade accessory pack

Morgan round bowl and drainer □ ▲

Overall dimensions: L900 x W480 x D175mm
Bowl size: 385mm diameter (D175mm)
Cut-out size: L870 x W450mm
Minimum cabinet size: 600mm
■ Reversible drainer
■ Clips included
■ Available with or without Cascade accessory pack
■ Waste not included – pack C waste kit and pack E overflow required

Stainless steel Without accessory pack	5310104	£97
Stainless steel With Cascade accessory pack	4128106	£117**

FRANKE



Ascona ASX 611 single bowl □ ▲

Overall dimensions: L860 x W510 x D175mm
Bowl size: L350 x W435 x D175mm
Cut-out size: L840 x W490mm
Minimum cabinet size: 500mm
■ Fixing clips included
■ Ascona 611 waste fixing kit required, see page 67
■ Reversible drainer

Stainless steel	7612142264009	£98
-----------------	---------------	------------

FRANKE

Compatible with waste disposal unit

50
YEAR
MANUFACTURER'S GUARANTEE



Ascona ASX 651 1½ bowl □ ▲

Overall dimensions: L1000 x W510 x D175mm
Bowl size: L350 x W435 x D175mm
½ Bowl size: L160 x W300 x D120mm
Cut-out size: L980 x W490mm
Minimum cabinet size: 600mm
■ Fixing clips included ■ Reversible drainer
■ Waste not included – Ascona 651 waste fixing kit required, see page 67

Stainless steel	7612142264016	£178
-----------------	---------------	-------------

BLANCO
GERMANY

50
YEAR
MANUFACTURER'S GUARANTEE

Compatible with waste disposal unit



Plus single bowl □ ▲

Overall dimensions: L860 x W500 x D160mm
Bowl size: L345 x W420 x D160mm
Cut-out size: L842 x W482mm
Minimum cabinet size: 450mm
■ Reversible drainer
■ Waste not included – pack 1 waste kit and overflow required
■ Integrated drainer waste
■ Factory fitted seal and fixing clips

Stainless steel	4020684530989	£112
Next day delivery	5035889074625	£125**

BLANCO
GERMANY

Compatible with waste disposal unit

50
YEAR
MANUFACTURER'S GUARANTEE

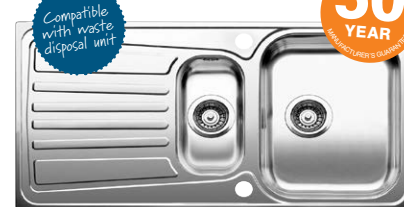

Plus 1½ bowl □ ▲

Overall dimensions: L950 x W500 x D160mm
Bowl size: L330 x W420 x D160mm
½ Bowl size: L160 x W310 x D130mm
Cut-out size: L933 x W483mm
Minimum cabinet size: 600mm
■ Reversible drainer
■ Waste not included – pack 2 waste kit and overflow required
■ Factory fitted seal and fixing clips

Stainless steel	4020684530996	£147
Next day delivery	5035889074632	£165**



Ammolite single bowl

Overall dimensions: L860 x W500 x D190mm
 Bowl size: L340 x W400 x D190mm
 Cut-out size: L838 x W478mm
 Minimum cabinet size: 600mm

- Reversible drainer
- Sealing strip and fixing clips included
- Waste not included – pack C waste kit and pack E overflow required

Stainless steel 5321339 **£128**



Ammolite 1 1/2 bowl

Overall dimensions: L1000 x W500 x D190/120mm
 Bowl size: L340 x W400 x D190mm
 1/2 Bowl size: L162 x W300 x D130mm
 Cut-out size: L978 x W478mm
 Minimum cabinet size: 600mm

- Reversible drainer
- Sealing strip and fixing clips included
- Waste not included – 2 x pack C waste kits required

Stainless steel 5321346 **£148**



Lantos single bowl

Overall dimensions: L940 x W490 x D155mm
 Bowl size: L330 x W420 x D155mm
 Cut-out size: L928 x W478mm
 Minimum cabinet size: 500mm

- Reversible drainer
- Waste not included – pack 1 waste kit and overflow required
- Factory fitted fixing clips
- 1mm flat edge profile giving a near flush fit with the work surface (IF)

Stainless steel 4020684530965 **£135**
 Next day delivery 5035889074649 **£148****



Lantos 1 1/2 bowl

Overall dimensions: L940 x W490 x D160mm
 Bowl size: L330 x W420 x D160mm
 1/2 Bowl size: L180 x W290 x D160mm
 Cut-out size: L928 x W478mm
 Minimum cabinet size: 600mm

- Reversible drainer
- Waste not included – pack 2 waste kit and overflow required
- Factory fitted fixing clips
- 1mm flat edge profile giving a near flush fit with the work surface (IF)

Stainless steel 4020684530972 **£165**
 Next day delivery 5035889074656 **£183****



Cubico single bowl

Overall dimensions: L1000 x W500 x D200mm
 Bowl size: L465 x W415 x D200mm
 Cut-out size: L980 x W480mm
 Minimum cabinet size: 600mm

- Reversible drainer
- Waste not included – pack C waste kit and pack E over flow required
- Compatible with accessories: **F** **H** (not included)

Polished steel 4069669 **Was £158 Now £140***



Cubico 1 1/2 bowl

Overall dimensions: L1000 x W500 x D175mm
 Bowl size: L350 x W415 x D175mm
 1/2 Bowl size: L160 x W285 x D120mm
 Cut-out size: L980 x W480mm
 Minimum cabinet size: 600mm

- Reversible drainer
- Waste not included – 2 x pack C waste kits required
- Compatible with accessories: **G** **H** **O**

Polished steel 4069676 **Was £178 Now £150***



Galassia GAX 611 single bowl

Overall dimensions: L1000 x W500 x D190mm
 Bowl size: L450 x W400 x D190mm
 Cut-out size: L980 x W480mm
 Minimum cabinet size: 600mm

- Waste, clips & sealing strip not included – GAX 611 fixing kit required, see page 165

Stainless steel Left hand 7612319416989 **£173**
 Stainless steel Right hand 7612319416972 **£173**



Mira single bowl

Overall dimensions: L868 x W508 x D218mm
 Bowl size: L340 x W400 x D200mm
 Cut-out size: L840 x W480mm
 Minimum cabinet size: 600mm

- Sealing strip and fixing clips included
- Waste kits included

Stainless steel Left hand 8017709148461 **£299**
 Stainless steel Right hand 8017709148454 **£299**

Turn to page 69 for accessories

Taps not included *£5 delivery also applies **includes waste kit

smeg
technology with style

Compatible with waste disposal unit

LIFE TIME
MANUFACTURER'S WARRANTY

Hot Trend



Mira 1½ bowl

Overall dimensions: L1008 x W508 x D218mm
Bowl size: L340 x W400 x D200mm
Cut-out size: L980 x W480mm
Minimum cabinet size: 600mm

- Sealing strip and fixing clips included
- Waste kits included

Stainless steel	Left hand	8017709148492	£249
Stainless steel	Right hand	8017709148485	£249

smeg
technology with style

LIFE TIME
MANUFACTURER'S WARRANTY

Hot Trend



Mira 2 bowl

Overall dimensions: L1168 x W508 x D218mm
Bowl size: L340 x W400 x D200mm
Cut-out size: L1140 x W480mm
Minimum cabinet size: 900mm

- Sealing strip and fixing clips included
- Waste kits included

Stainless steel	Left hand	8017709148515	£398
Stainless steel	Right hand	8017709148508	£398

COOKE & LEWIS

Compatible with waste disposal unit

LIFE TIME
MANUFACTURER'S WARRANTY



Korner wave single bowl

Overall dimensions: L1000 x W500 x D200mm
Bowl size: L465 x W415 x D200mm
Cut-out size: L980 x W480mm
Minimum cabinet size: 600mm

- Reversible drainer
- Waste not included – pack C waste kit and pack E overflow required
- Compatible with accessories: **F H**

Polished steel	4069546	Was £197 Now £140*
----------------	---------	---------------------------

COOKE & LEWIS

LIFE TIME
MANUFACTURER'S WARRANTY

Compatible with waste disposal unit



Korner wave 1½ bowl

Overall dimensions: L1000 x W500 x D175mm
Bowl size: L350 x W415 x D175mm
½ Bowl size: L160 x W285 x D120mm
Cut-out size: L980 x W480mm
Minimum cabinet size: 600mm

- Reversible drainer
- Waste not included – 2 x pack C waste kits required
- Compatible with accessories: **G H O**

Polished steel	4069553	Was £227 Now £150*
----------------	---------	---------------------------

COOKE & LEWIS

Compatible with waste disposal unit

LIFE TIME
MANUFACTURER'S WARRANTY



Unik single bowl sink with drainer

Overall dimensions: L910 x W560 x D190mm
Bowl size: L410 x W410 x D190mm
Cut-out size: L888 x W458mm
Minimum cabinet size: 700mm

- Includes clips and sealant strip
- Auto pop strainer and overflow pipe included

Stainless steel	5348305	£198
-----------------	---------	-------------

FRANKE

Compatible with waste disposal unit

50 YEAR
MANUFACTURER'S WARRANTY



Erica EUX 651 1½ bowl

Overall dimensions: L965 x W500 x D175mm
Bowl size: L340 x W420 x D175mm
½ Bowl size: L165 x W300 x D130mm
Cut-out size: L949 x W484mm
Minimum cabinet size: 600mm

- Sealing strip included
- Reversible drainer
- Waste and clips not included – EUX 651 waste kit required, see page 67

Stainless steel	7612142105036	£195
-----------------	---------------	-------------

COOKE & LEWIS



Passo single bowl

Overall dimensions: L1000 x W500 x D200mm
Bowl size: L465 x W415 x D200mm
Cut-out size: L980 x W480mm
Minimum cabinet size: 600mm

- Reversible drainer
- Waste not included – pack C waste kit and pack E overflow required
- Compatible with accessories: **F H**

Polished steel	4069683	Was £205 Now £140*
----------------	---------	---------------------------

COOKE & LEWIS

Compatible with waste disposal unit

LIFE TIME
MANUFACTURER'S WARRANTY



Passo 1½ bowl

Overall dimensions: L1000 x W500 x D175mm
Bowl size: L350 x W415 x D175mm
½ Bowl size: L160 x W285 x D120mm
Cut-out size: L980 x W480mm
Minimum cabinet size: 600mm

- Reversible drainer
- Waste not included – 2 x pack C waste kits required
- Compatible with accessories: **G H O**

Polished steel	4069690	Was £225 Now £150*
----------------	---------	---------------------------



Laser LSX 611 single bowl

Overall dimensions: L895 x W510 x D175mm
 Bowl size: L390 x W445 x D175mm
 Cut-out size: L882 x W497mm
 Minimum cabinet size: 500mm

- Fixing clips included
- Reversible drainer
- Waste and overflow included

Stainless steel 7612980597604 **£247**

FRANKE



Laser LSX 651 1½ bowl

Overall dimensions: L990 x W500 x D175mm
 Bowl size: L350 x W435 x D175mm
 ½ Bowl size: L165 x W300 x D120mm
 Cut-out size: L977 x W487mm
 Minimum cabinet size: 600mm

- Fixing clips included
- Reversible drainer
- Waste and overflow included

Stainless steel 7612980596430 **£307**

COOKE
&LEWIS



Prase single bowl

Overall dimensions: L1000 x W500 x D200mm
 Bowl size: L465 x W415 x D200mm
 Cut-out size: L980 x W480mm
 Minimum cabinet size: 600mm

- Reversible drainer
- Includes waste and overflow

Polished steel 4069508 **£332**

COOKE
&LEWIS



Prase 1½ bowl

Overall dimensions: L1000 x W500 x D175mm
 Bowl size: L350 x W415 x D175mm
 ½ Bowl size: L160 x W285 x D120mm
 Cut-out size: L980 x W480mm
 Minimum cabinet size: 600mm

- Reversible drainer
- Includes wastes, overflow and pipework

Polished steel 4069515 **£352**

COOKE
&LEWIS



Vetta single bowl

Overall dimensions: L1000 x W530 x D190mm
 Bowl size: L470 x W400 x D190mm
 Cut-out size: L980 x W510mm
 Minimum cabinet size: 600mm

- Includes waste and overflow
- Reversible drainer

Brushed steel 4076100 **£384**

Grid 4076285 **£25**

Chopping board 4077626 **£55**

COOKE
&LEWIS



Vetta 1½ bowl

Overall dimensions: L1000 x W530 x D190mm
 Bowl size: L340 x W400 x D190mm
 ½ Bowl size: L160 x W400 x D160mm
 Cut-out size: L980 x W510mm
 Minimum cabinet size: 600mm

- Includes wastes and overflow
- Reversible drainer

Brushed steel 4076117 **£404**

Grid 4076292 **£27**

Chopping board 4077626 **£55**

Colander 4076308 **£12**

FRANKE



Mythos MMX 661 1½ bowl

Overall dimensions: L1000 x W520 x D175mm
 Bowl size: L340 x W400 x D175mm
 ½ Bowl size: L160 x W400 x D130mm
 Cut-out size: L989 x W509mm
 Minimum cabinet size: 600mm

- Fixing clips included
- Waste included
- Includes glass chopping board and 1/2 bowl basket

Stainless steel Left hand 7612142262333 **£472**

Stainless steel Right hand 7612142262340 **£472**

FRANKE



Kubus KBV 611 single bowl

Overall dimensions: L1000 x W530 x D180mm
 Bowl size: L450 x W400 x D180mm
 Cut-out size: L980 x W510mm
 Minimum cabinet size: 500mm

- Waste included
- Toughened black glass frame, stainless steel bowl, matt drainer

Black glass Left hand 7612142261619 **£493**

Black glass Right hand 7612142261626 **£493**

FRANKE

50
YEAR
MANUFACTURER'S WARRANTY

Compatible
with waste
disposal unit



Kubus KBV 651 1½ bowl

Overall dimensions: L1000 x W530 x D175mm
Bowl size: L340 x W400 x D175mm
½ Bowl size: L160 x W400 x D130mm
Cut-out size: L980 x W510mm
Minimum cabinet size: 600mm

- Waste included
- Toughened black glass frame, stainless steel bowl, matt drainer
- Kubus accessory pack available (not included)

Black glass	Left hand	7612142261633	£586
Black glass	Right hand	7612142261640	£586
Accessories pack		7612980472468	£98

Food waste disposers

If you're looking for an easier way to deal with food waste, here's a simple solution. InSinkerator food waste disposers are the hygienic and convenient way to deal with messy household food waste.

- Dispose of most types of food waste
- Waste is ground to fine particles and safely washed away through standard plumbing
- Means no smelly, messy bins or build-up of bacteria
- Compact and easy to install under most new or existing sinks

in sinkerator
solutions for sinks
EMERSON



M45 waste disposal unit with built in airswitch

- 2 Year manufacturer's warranty parts and labour
- Ideal for the smaller household
- Activated by worktop mounted air switch

50375006381 **£97**



M55 waste disposal unit

- 3 Year manufacturer's warranty parts and labour
- Ideal for larger family households
- Powerful 0.55 HP motor
- Stainless steel grind elements

50375002123 **£175**



Evolution 100 food waste disposer

- 5 Year manufacturer's warranty parts and labour
- Ideal for a family size household
- 40% quieter than m45 and m55 disposers
- Two-stage grind technology
- Built in air switch

50375010562 **Was £327 Now £227**



Sink accessories

A Style ½ bowl colander

5016182157499 **£12**



B Style single bowl basket

S/steel	5397007158427	£12
White	5397007158403	£7
Silver effect	5397007158410	£7

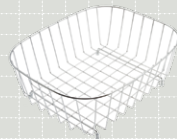

C Style 1½ bowl basket

S/steel	5397007158458	£13
White	5397007158434	£8
Silver effect	5397007158441	£8

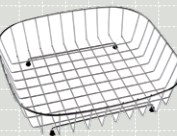

D Style drainer rack

S/steel	5397007158243	£12
White	5397007158229	£8
Silver effect	5397007158236	£8

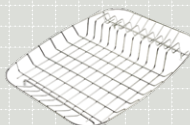

E Cooke & Lewis Thermo beech chopping board

4077619 **£28**



F Passo/Cubico single bowl grid

4076162 **£15**



G Passo/Cubico 1½ bowl grid

4076179 **£20**

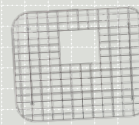

H Passo/Cubico chopping board with handle

4076186 **£23**



M Tanzan colander

5016182100785 **£14**



N Design main bowl basket

S/steel	5397007158397	£13
White	5397007158274	£8
Silver effect	5397007158380	£8

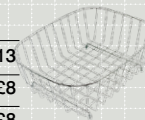

O Passo/Cubico ½ bowl basket

4076193 **£9**



A VARIETY OF
SIZES AND
DESIGNS

ceramic sinks

Ceramic sinks are becoming increasingly popular and seen as a material that can look stunning in contemporary as well as the usual traditional kitchen environment. They are individually hand crafted and finished in fireclay, are cool and silky to touch and have a non-porous surface which means they are very easy to keep clean. A simple wipe down after use will keep the sink stain free and looking fantastic for years to come!

ASTRACAST®
Innovation • design • performance



5
YEAR
MANUFACTURER'S GUARANTEE

Amazing
Value

Belfast sink single bowl

Overall dimensions: L595 x W455 x D255mm

Bowl size: L524 x W384 x D255mm

Minimum cabinet size: 600mm

- Waste kit and chain included
- Use with Belfast sink base cabinet
- Made from traditional fireclay ceramic

Gloss white 5016182122664 **£182**

ASTRACAST®
Innovation • design • performance



5
YEAR
MANUFACTURER'S GUARANTEE

Butler drainer

Overall dimensions: L460 x W470 x D500mm

- Made from traditional fireclay ceramic

Gloss white 50161821265326 **£98**

ASTRACAST®
Innovation • design • performance



5
YEAR
MANUFACTURER'S GUARANTEE

Aquitaine single bowl

Overall dimensions: L970 x W520 x D168mm

Bowl size: L400 x W420 x D168mm

Cut-out size: L930 x W480mm (corner radius 55mm)

Minimum cabinet size: 500mm

- Pack C waste kit and overflow included
- Reversible drainer
- Ceramic tap stopper included
- Made from traditional fireclay ceramic

Gloss white 5016182105568 **£187**

ASTRACAST®
Innovation • design • performance



5
YEAR
MANUFACTURER'S GUARANTEE

Aquitaine 1½ bowl

Overall dimensions: L970 x W520 x D168mm

Bowl size: L350 x W420 x D168mm

½ Bowl size: L145 x W250 x D120mm

Cut-out size: L930 x W480mm (corner radius 55mm)

Minimum cabinet size: 600mm

- 2 x Pack C waste kits and pipework included
- Reversible drainer
- Ceramic tap stopper included
- Made from traditional fireclay ceramic

Gloss white 5016182122657 **£217**

BLANCO
GERMANY



5
YEAR
MANUFACTURER'S GUARANTEE

Setura single bowl

Overall dimensions: L860 x W500 x D220mm

Bowl size: L360 x 380 x D200mm

Cut-out size: L810 x W460mm

Minimum cabinet size: 500mm

- 3½ BSW and overflow
- Waste included
- Reversible drainer
- Traditional Ceramic with a high gloss white finish

Gloss white 5035889069027 **£187**

BLANCO
GERMANY



5
YEAR
MANUFACTURER'S GUARANTEE

Setura 1½ bowl

Overall dimensions: L1000 x W500 x D220mm

Bowl size: L340 x W380 x D200mm

½ Bowl size: L140 x w260 x D110mm

Cut-out size: L950 x W460mm

Minimum cabinet size: 600mm

- 3½* and 1½ BSW
- 2x wastes included
- Reversible drainer
- Traditional Ceramic with a high gloss white finish

Gloss white 5035889069034 **£217**

ASTRACAST®
Innovation • design • performance



5
YEAR
MANUFACTURER'S GUARANTEE

Cascade single bowl

Overall dimensions: L800 x W480 x D180mm

Bowl size: 385mm diameter

Cut-out size: L766 x W456mm (corner radius 240mm)

Minimum cabinet size: 450mm

- Reversible drainer
- Includes waste and overflow
- Ceramic tap stopper included
- Cascade accessory pack available

Gloss white 5016203741676 **£194**

All guarantees are manufacturer guarantees. This does not affect your legal rights.

Taps not included.



composite sinks

Composite sinks are manufactured using real quartz particles meaning they have unrivalled performance characteristics. The strength and durability of quartz means composite sinks are incredibly hard wearing and will withstand everyday use without any effect. They are almost impossible to scratch, will withstand very high temperatures and are extremely resistant to chemicals and staining. If you are looking for a real work horse, that will keep its good looks for years to come, then a composite sink is for you!

ASTRACAST[®]
Innovation • design • performance



5
YEAR
MANUFACTURER'S WARRANTY

Sonata teflite single bowl

Overall dimensions: L980 x W500 x D170mm
Bowl size: L400 x W418 x D170mm
Minimum cabinet size: 500mm
■ Sealing strip and fixing clips included
■ 1 x Pack C waste kit required ■ Reversible drainer
■ Compatible with accessories: **N**

Black 5016182179651 **£97**

ASTRACAST[®]
Innovation • design • performance



5
YEAR
MANUFACTURER'S WARRANTY

Sonata teflite 1 1/2 bowl

Overall dimensions: L980 x W500 x D170mm
Bowl size: L339 x W418 x D170mm
1/2 Bowl size: L148 x W296 x D126mm
Minimum cabinet size: 600mm
■ Sealing strip and fixing clips included
■ 2 x Pack C waste kits required ■ Reversible drainer
■ Compatible with accessories: **N P**

Black 5016182179682 **£117**

COOKE
& LEWIS



50
YEAR
MANUFACTURER'S WARRANTY

Vascite single bowl

Overall dimensions: L860 x W500 x D200mm
Bowl size: L353 x W396 x D200mm
Cut-out size: L840 x W480mm
Minimum cabinet size: 450mm
■ Eurogranite¹ material for toughness and durability
■ Ultra smooth and easy to clean surface
■ Embedded silver ions prevent 99% of bacterial growth
■ Temperature resistant surface up to 280°C
■ Reversible drainer ■ Waste and overflow included

White 4073734 **£162**
Volcanic black 4073727* **£162**

COOKE
& LEWIS



50
YEAR
MANUFACTURER'S WARRANTY

Vascite 1 1/2 bowl

Overall dimensions: L970 x W500 x D200mm
Bowl size: L340 x W396 x D200mm
1/2 Bowl size: L164 x W306 x D135mm
Cut-out size: L950 x W480mm
Minimum cabinet size: 600mm
■ Eurogranite¹ material for toughness and durability
■ Ultra smooth and easy to clean surface
■ Embedded silver ions prevent 99% of bacterial growth
■ Temperature resistant surface up to 280°C
■ Reversible drainer ■ Waste and overflow included

White 4073758 **£182**
Volcanic black 4073741* **£182**

don't forget...

Astraclean

5016203783324 **£14**

- Specifically formulated to break down limescale on granite & composite sinks
- Removes grease and other food substances
- Kills germs and bacteria on contact
- Fresh fragrance
- Acts as a general sink cleaner
- Fully biodegradable to European standards

N Design main bowl basket

Stainless steel	5397007158397	£13
White	5397007158274	£8
Silver effect	5397007158380	£8

P Design 1/2 bowl basket

Stainless steel	5397007158267	£12
White	5397007158250	£7

T Axin single bowl grid

4074151 **£17**

U Axin 1 1/2 bowl grid



4074168 **£16**

V Axin 1/2 basket

4074175 **£15**



20
YEAR
MANUFACTURER'S GUARANTEE

Cascade single bowl  

- Overall dimensions: L790 x W480 x D180mm
 Bowl size: 385mm diameter
 Cut-out size: L766 x W456mm
 Minimum cabinet size: 450mm
- Reversible drainer
 - Includes waste and overflow
 - Cascade accessory pack available



don't forget...

Cascade accessories pack 



- Comprises: Beech chopping board, glass chopping board and colander

5016203746886 **£45**

Volcano black 5016203741799 **£177**



10
YEAR
MANUFACTURER'S GUARANTEE



Sirius SID611 single bowl  

- Overall dimensions: L1000 x W510 x D200mm
 Bowl size: L450 x W410 x D200mm
 Cut-out size: L980 x W490
 Minimum cabinet size: 500mm
- Resilient flexible light construction
 - Reversible sink
 - Attractive minimalist design
 - Waste and overflow included

Volcanic black 7612980609710* **£193**
 White 7612980609727 **£193**



10
YEAR
MANUFACTURER'S GUARANTEE

Sirius SID651 1 1/2 bowl  

- Overall dimensions: L1000 x W510 x D200mm
 Bowl size: L350 x W410 x D200mm
 1/2 Bowl size: L160 x W350 x D160mm
 Cut-out size: L980 x W490
 Minimum cabinet size: 600mm
- Resilient flexible light construction
 - Reversible sink
 - Attractive minimalist design
 - Waste and overflow included

Volcanic black 7612980609598* **£213**
 White 7612980609604 **£213**



*Composite material that includes granite particles.

Taps not included.

A VARIETY OF
SIZES AND
DESIGNS

sinks with accessories

BLANCO
GERMANY



Classic single bowl

Overall dimensions: L915 x W510 x D175mm

Bowl size: L340 x W420 x D175mm

Cut-out size: L891 x W486mm

Minimum cabinet size: 500mm

- Reversible drainer ■ Standard waste
- Smooth stone like surface ■ Fixing clips included

Anthracite	5035889062561	was £228	Now £178
Next day delivery	5035889074205	£228**	
Champagne	5035889062578	was £228	Now £178
Next day delivery	5035889074519	£228**	

New
lower
price
£178

BLANCO
GERMANY



Classic 1 1/2 bowl

Overall dimensions: L1000 x W510 x D175mm

Bowl size: L340 x W420 x D175mm

1/2 Bowl size: L180 x W290 x D130mm

Cut-out size: L976 x W486mm

Minimum cabinet size: 600mm

- Reversible drainer ■ Standard waste
- Smooth stone like surface ■ Fixing clips included

Anthracite	5035889062585	was £248	Now £198
Next day delivery	5035889074526	£248**	
Champagne	5035889062592	was £248	Now £198
Next day delivery	5035889074533	£248**	

New
lower
price
£198

COOKE
& LEWIS



Veneto single bowl

Overall dimensions: L1000 x W520 x D170mm

Bowl size: L422 x W456 x D170mm

Cut-out size: L976 x W496mm

Minimum cabinet size: 600mm

- Includes waste and overflow
- Reversible drainer
- Unique slate texture

Volcano black	4076148	£235
Single bowl grid	4076247	£10
Wooden chopping board	4076261	£25

COOKE
& LEWIS



Veneto 1 1/2 bowl

Overall dimensions: L1000 x W520 x D170mm

Bowl size: L361 x W456 x D170mm

1/2 Bowl size: L150 x W300 x D107mm

Cut-out size: L976 x W496mm

Minimum cabinet size: 600mm

- Includes wastes, overflow and pipework
- Reversible drainer
- Unique slate texture

Volcano black	4076155	£257
1 1/2 Single bowl grid	4076254	£13
1 1/2 Wooden chopping board	4076261	£25
Colander	4076278	£15

COOKE
& LEWIS

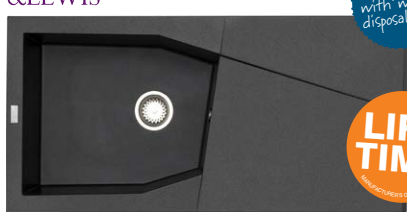

Lazio single bowl

Overall dimensions: L1080 x W520 x D198mm

Bowl size: L527 x W430 x D198mm

Cut-out size: L1056 x W495mm

Minimum cabinet size: 600mm

- Includes waste and overflow
- Reversible drainer

Volcano black	4076124	£247
Single bowl grid	4076209	£14
Wooden chopping board	4076223	£20

COOKE
& LEWIS



Lazio 1 1/2 bowl

Overall dimensions: L1080 x W520 x D198mm

Bowl size: L527 x W430 x D198mm

1/2 Bowl size: L165 x W308 x D173mm

Cut-out size: L1056 x W495mm

Minimum cabinet size: 600mm

- Includes wastes and pipework
- Reversible drainer

Volcano black	4076131	£277
1 1/2 Single bowl grid	4076216	£15
1 1/2 Wooden chopping board	4076223	£20
Colander	4076230	£18

**includes waste kit

¹Composite material that includes granite particles.

A VARIETY OF
SIZES AND
DESIGNS

undermount sinks

COOKE
& LEWIS



15
YEAR
MANUFACTURER'S GUARANTEE

Nitoite undermount drainer tray 🗉

Overall dimensions: L430 x W450 x D30mm
Bowl size: L380 x W400 x D30mm
Cut-out size: L384 x W404mm
Minimum cabinet size: 600mm
■ Fixing clips included
■ Suitable for inset and undermount
■ Jig required, please see page 45

Stainless steel 5321407 **£50**

ASTRACAST
innovation • design • performance



10
YEAR
MANUFACTURER'S GUARANTEE

Compatible
with waste
disposal unit

Isabella undermount single bowl 🗉 ▲

Overall dimensions: L422 x W372 x D194mm
Bowl size: L400 x W350 x D194mm
Cut-out size: Template supplied
Minimum cabinet size: 450mm
■ Fixing clips included
■ Pack C waste kit and pack E overflow included
■ Jig required, please see page 45
■ Compatible with accessories: AG AH

Polished steel 5016182179408 **£108**

COOKE
& LEWIS



15
YEAR
MANUFACTURER'S GUARANTEE

Nitoite single bowl 🗉 ▲

Overall dimensions: L430 x W450 x D185mm
Bowl size: L380 x W400 x D185mm
Cut-out size: L384 x W404mm
Minimum cabinet size: 600mm
■ Fixing clips included ■ Suitable for inset and undermount
■ Jig required, please see page 45
■ This sink is not reversible

Stainless steel 5321360 **£114**

COOKE
& LEWIS



15
YEAR
MANUFACTURER'S GUARANTEE

Nitoite 1 1/2 bowl undermount 🗉 ▲

Overall dimensions: L692 x W450 x D185mm
Bowl size: L380 x W400 x D185mm
1/2 Bowl size: L230 x W400 x D185mm
Cut-out size: L646 x W404mm
Minimum cabinet size: 700mm
■ Fixing clips included ■ Suitable for inset and undermount
■ Jig required, please see page 45
■ This sink is not reversible

Stainless steel 5321391 **£164**

ASTRACAST
innovation • design • performance



5
YEAR
MANUFACTURER'S GUARANTEE

Lincoln undermount 1 1/2 bowl 🗉 ▲

Overall dimensions: L544 x W440 x D180mm
Bowl size: L335 x W390 x D180mm
1/2 Bowl size: L145 x W280 x D116mm
Cut-out size: Template supplied
Minimum cabinet size: 600mm
■ Suited to any solid surface material
■ Gloss white fireclay finish
■ Includes wastes ■ Right hand only

Gloss white fireclay 5016203764040 **£315**

FRANKE



50
YEAR
MANUFACTURER'S GUARANTEE

Compact CPX 160 undermount 1 1/2 bowl 🗉 ▲

Overall dimensions: L580 x W470 x D175mm
Bowl size: L340 x W420 x D175mm
1/2 Bowl size: L165 x W300 x D130mm
Cut-out size: Template supplied
Minimum cabinet size: 600mm
■ Reversible sink
■ Includes wastes and overflow
■ Centred half bowl sink
■ Jig required, please see page 45

Stainless steel 7612142262807 **£243**

BLANCO
GERMANY



50
YEAR
MANUFACTURER'S GUARANTEE

Blanonova 6-U undermount 1 1/2 bowl 🗉

Overall dimensions: L592 x W477 x D200mm
Bowl size: L340 x W420 x D190mm
1/2 Bowl size: L160 x W310 x D130mm
Cut-out size: Template supplied
Minimum cabinet size: 800mm
■ Reversible sink
■ Includes waste and overflow
■ Includes smoke grey colander
■ Jig required, please see page 45

Anthraxite ▲ 5035889068419 **£305**

Next day delivery ▲ 5035889074557 **£305****

White 5035889068426 **£305**

Next day delivery 5035889074540 **£305****

Taps not included. **includes waste kit

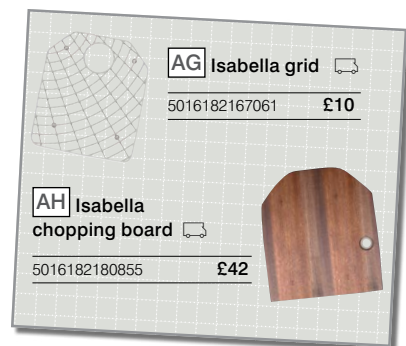

AG Isabella grid 🗉
5016182167061 **£10**

AH Isabella chopping board 🗉
5016182180855 **£42**

†Composite material that includes granite particles.

All guarantees are manufacturer guarantees. This does not affect your legal rights.



Peak PKX110 70 undermount sink

Overall dimensions: L730 x W450 x D180mm
 Bowl size: L700 x W420 x D180mm
 Cut-out size: Template supplied
 Minimum cabinet size: 800mm
 ■ Extra large single bowl undermount sink
 ■ Includes square basket drainer waste
 ■ Jig required, please see page 45

Stainless steel 7612980440122 **£367**

Corner sinks

COOKE & LEWIS



Hema 2 bowl corner

Overall dimensions: L830 x W830 x D188mm
 Bowl size: L340 x W400 x D178mm
 Cut-out size: L812 x W812mm
 ■ Sealing strip and fixing clips included
 ■ 2 x Pack C waste kits and 1 x pack E overflow required

Stainless steel 5321322 **£98**

Round sinks

ASTRACAST
 Innovation • design • performance



Pinta flush undermount inset drainer

Overall dimensions: L430 x W430 x D35mm
 Bowl size: 380mm diameter
 Cut-out size: L376 x W376mm
 Minimum cabinet size: 500mm
 ■ Ideal for inset or undermount installation
 ■ Inset pack F required
 ■ Undermount pack F and L required

Polished steel 5016203746978 **£34**

ASTRACAST
 Innovation • design • performance



Pinta flush undermount inset bowl

Overall dimensions: L430 x W430 x D175mm
 Bowl size: 380mm diameter
 Cut-out size: L376 x W376mm
 Minimum cabinet size: 500mm
 ■ Ideal for inset or undermount installation
 ■ Round bowl basket available 5016182131857
 ■ Inset pack C and E required
 ■ Or for undermount pack C, E and L required
 ■ Jig required, please see page 45

Polished steel 5016203746961 **£38**

Waste packs

Brand	Product	Colour	Compatible with sink no.	Barcode	Price
●●●●●	Pack A 1½" Combined waste with overflow	Chrome	1, 2, 3	5016182121742	£5
	Pack C 3½" Basket strainer waste	Chrome	4-22, 41, 43-47, 50-54, 57-64, 67-69, 72-76, 78	5016182121803	£10
		White		5016182121780	£10
	Pack E Slotted overflow kit	Chrome	4-10, 12, 13, 15, 17, 19-22, 43, 45, 48, 53, 57, 59-61, 63, 68, 69, 72, 73, 75, 78	5016182121834	£4
	Pack F Round drainer kit	Stainless steel	47, 52, 76, 77	5016182121841	£4
		White		5016182121858	£4
Pack G Round overflow kit	Chrome	47, 52, 53, 54, 76	5016182121872	£3	
	Chrome	4-22, 41, 43-47, 50-54, 57-64, 67-69, 72-77	5016182158847	£18	
FRANKE	Ascona ASX 651 fixing kit		24	7612980461448	£15
	Ascona ASX 611 fixing kit		23	7612980461431	£10
	Galassia GAX 611 fixing kit		25	7612142243332	£10
	Erica EUX 651 fixing kit		26	7612142243356	£10
BLANCO GERMANY	Pack 1 Bowl waste kit		37, 39	5035889034070	£13
	Pack 2 Bowl waste kit		36, 38, 40	5035889062691	£18
	Pack 3 Waste kit		35	5035889063643	£10

Installation packs

Brand	Product	Colour	Barcode	Price
FRANKE	Siphon 1 plumbing kit	-	7612980045211	£17
	Siphon 11 plumbing kit	-	7612980035403	£23
●●●●●	Pack H Single bowl pipe work kit (SP10)	-	5016182121889	£3
	Pack I 1½ Bowl pipe work kit (SP20)	-	5016182121896	£6
	Pack J Waste pipe trap	-	5016182121902	£7
	Pack L Undermount brackets	-	5016182122121	£12
	Clip and sealant pack	-	5011818033994	£6



Looks better!

Looks good?

Upgrades your sink's appearance in seconds, suitable for both retrofit and new sinks.

Topper
Basket Strainer Waste Cover

Complete the look of any sink
For details enquire in store.

CHOOSING THE RIGHT TAP FOR YOU

kitchen taps

- Selected taps available for next day delivery

One of the most extensive collections you'll find, with names like Franke, Brita, Blanco, Grohe and Smeg, to our exclusive Cooke & Lewis range. We offer a huge choice of styles and finishes to complement any sink.

HP
high pressure
Suitable for high pressure water systems only.

LP HP
low or high pressure
Suitable for low or high pressure water systems.

2
tap holes
Number of tap holes required for installation

single/side lever
Controls temperature and flow with one side lever.

ceramic disc valve operation
More hardwearing valves with easier, low friction operation. Available in either 1/4 turn or single lever styles.

don't forget...

You need to check if you have a high or low pressure water system and choose your tap accordingly. We've created this guide to help you.

low pressure water system



You have a cold water tank in your loft and a hot water tank in your airing cupboard.

You can choose any of our low pressure taps (minimum operating pressure of 0.1 - 0.5bar).

high pressure water systems

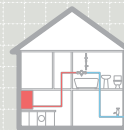

1. You have a boiler unit but no hot water cylinder, the boiler unit is usually found in the kitchen and delivers hot water on demand.

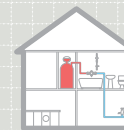

2. You have a hot water cylinder with an expansion vessel on top, usually found in the airing cupboard, but you do not have a cold water tank. You should be able to choose any of our taps.

Pillar taps



Athens pillar taps
■ Compression valve operation
■ Twin controls

Chrome finish 5178803 £15



Madrid pillar taps
■ Compression valve operation
■ Twin controls

Chrome finish 5320639 £20



Boston pillar taps
■ Quarter turn ceramic disc valve operation
■ Easy to use twin lever controls

Chrome finish 5178865 £23



Vienna pillar taps
■ Compression valve operation
■ Twin controls

Chrome finish 5320622 £24



Saverne pillar taps
■ Quarter turn ceramic disc valve operation
■ Easy to use twin lever controls

Chrome finish 5320615 £38

We fit taps

from **£49**

Subject to survey

B&Q Homefit

APPROVED tradesmen - fixed prices

















*Please note that mains water pressure can vary and may not always be sufficient for some taps. If you are in any doubt, you can check your supply pressure using a water pressure gauge (available at B&Q).

All guarantees are manufacturer guarantees. This does not affect your legal rights.

how to shop • in-store • online www.diy.com • phone 0870 0101 006

Our Banbury, Bedford, Burgess Hill, Bognor Regis, Consett, Eastleigh, Fareham, Hedge End, Nursing, Poole, Portsmouth, Port Glasgow and Sydenham stores stock a wide range of products - all available to take away. The symbol is used throughout this Buying Guide to indicate the products that these stores stock. However these are subject to availability and ranges may vary by store.

Deck mixer taps

 <p>New lower price</p> <p>1 YEAR MANUFACTURER'S GUARANTEE</p> <p>2 LP HP 0.2 Bar take home today</p>	 <p>New lower price</p> <p>1 YEAR MANUFACTURER'S GUARANTEE</p> <p>2 LP HP 0.2 Bar</p>	 <p>1 YEAR MANUFACTURER'S GUARANTEE</p> <p>2 LP HP 0.2 Bar</p>	 <p>2 YEAR MANUFACTURER'S GUARANTEE</p> <p>2 LP HP 0.1 Bar</p>	 <p>1 YEAR MANUFACTURER'S GUARANTEE</p> <p>2 LP HP 0.2 Bar take home today</p>	 <p>2 YEAR MANUFACTURER'S GUARANTEE</p> <p>2 LP HP 0.1 Bar</p>
<p>Athens deck mixer  </p> <ul style="list-style-type: none"> ■ Compression valve operation ■ Swivel spout <p>Chrome finish 5178810 £30</p>	<p>Boston deck mixer  </p> <ul style="list-style-type: none"> ■ Quarter turn ceramic disc valve operation ■ Easy to use twin lever controls <p>Chrome finish 5335893 £38</p>	<p>Madrid deck mixer </p> <ul style="list-style-type: none"> ■ Compression valve operation ■ Swivel spout <p>Chrome finish 5320646 £48</p>	<p>Saverne deck mixer </p> <ul style="list-style-type: none"> ■ Quarter turn ceramic disc valve operation ■ Swivel spout ■ Easy to use twin lever controls <p>Chrome finish 5320660 £62</p>	<p>Vienna deck mixer  </p> <ul style="list-style-type: none"> ■ Compression valve operation ■ Swivel spout <p>Chrome finish 5320653 £64</p>	<p>Tone deck mixer  </p> <ul style="list-style-type: none"> ■ Quarter turn ceramic disc valve operation ■ Swivel spout ■ Easy to use twin lever controls <p>Chrome finish 5257959 £67</p>

Monobloc taps

 <p>1 YEAR MANUFACTURER'S GUARANTEE</p> <p>1 LP HP 0.2 Bar take home today</p>	 <p>1 YEAR MANUFACTURER'S GUARANTEE</p> <p>1 LP HP 0.2 Bar</p>	 <p>1 YEAR MANUFACTURER'S GUARANTEE</p> <p>1 LP HP 0.3 Bar take home today</p>	 <p>1 YEAR MANUFACTURER'S GUARANTEE</p> <p>1 LP HP 0.2 Bar</p>	 <p>2 YEAR MANUFACTURER'S GUARANTEE</p> <p>1 LP HP 0.5 Bar take home today</p>	 <p>2 YEAR MANUFACTURER'S GUARANTEE</p> <p>1 LP HP 0.3 Bar</p>
<p>Madrid monobloc </p> <ul style="list-style-type: none"> ■ Compression valve operation ■ Swivel spout <p>Chrome finish 5320677 £38</p>	<p>Athens monobloc </p> <ul style="list-style-type: none"> ■ Compression valve operation ■ Swivel spout <p>Chrome finish 5178827 £38</p> <p>White 5178858 £35</p> <p>Coffee 5178834 £38</p>	<p>Boston monobloc </p> <ul style="list-style-type: none"> ■ Quarter turn ceramic disc valve operation ■ Easy to use twin lever controls <p>Chrome finish 5335909 £43</p>	<p>Vienna monobloc </p> <ul style="list-style-type: none"> ■ Compression valve operation ■ Swivel spout <p>Chrome finish 5320707 £47</p>	<p>Gatun monobloc </p> <ul style="list-style-type: none"> ■ Ceramic disc cartridge ■ Swivel spout ■ Quarter turn twin controls <p>Chrome finish 4059219 £68</p>	<p>Saverne monobloc  </p> <ul style="list-style-type: none"> ■ Quarter turn ceramic disc valve operation ■ Swivel spout ■ Easy to use twin lever controls <p>Chrome finish 5320684 £52</p> <p>Stainless steel effect* 5320691 £62</p>



2
YEAR
MANUFACTURER'S GUARANTEE

1
LP
HP
0.3 Bar
take home today

Reno monobloc

- Quarter turn ceramic disc valve operation
- Swivel spout
- Easy to use twin lever controls

Chrome finish 5335923 **£54**
Stainless steel effect 5335930 **£64**



2
YEAR
MANUFACTURER'S GUARANTEE

1
LP
HP
0.2 Bar
take home today

Dalmuir monobloc

- Quarter turn ceramic disc valve operation
- Swivel spout
- Easy to use twin lever controls

Chrome finish 5335916 **£43**

COOKE
& LEWIS

**New
lower
price**

Tone monobloc

- Quarter turn ceramic disc valve operation
- Swivel spout
- Easy to use twin lever controls

Chrome finish 5257966 **£58**
Stainless steel effect 5257973 **£78**



5
YEAR
MANUFACTURER'S GUARANTEE

1
LP
HP
0.5 Bar
take home today

Teshio monobloc

- Ceramic disc cartridge
- Swivel spout
- Easy to use twin lever controls

Chrome finish 4055884 **£95**

BLANCO
GERMANY



5
YEAR
MANUFACTURER'S GUARANTEE

1
LP
HP
0.5 Bar
take home today

Silk monobloc

- Quarter turn ceramic disc valve operation
- Swivel spout
- Easy to use twin lever controls

Chrome finish 5035889066903 **£95**
Next day delivery 5035889074038 **£95**

FRANKE



1
YEAR
MANUFACTURER'S GUARANTEE

5
YEAR
MANUFACTURER'S GUARANTEE

1
LP
HP
0.5 Bar
take home today

Zurich monobloc

- ¼ turn ceramic disc valve operation
- Bi-flow swivel spout
- Easy to use twin lever controls

Chrome finish 7612404003803 **£97**
Next day delivery 7612981199074 **£97**

COOKE
& LEWIS



2
YEAR
MANUFACTURER'S GUARANTEE

1
LP
HP
0.3 Bar
take home today

Esna monobloc

- Quarter turn ceramic disc valve operation
- Swivel spout
- Easy to use twin lever controls

Chrome finish 5257980 **£78**



1
YEAR
MANUFACTURER'S GUARANTEE

5
YEAR
MANUFACTURER'S GUARANTEE

1
LP
HP
0.5 Bar
take home today

Ascona monobloc

- Quarter turn ceramic disc valve operation
- Swivel spout
- Easy to use twin lever controls

Chrome finish 7612980758104 **£112**

FRANKE



1
YEAR
MANUFACTURER'S GUARANTEE

5
YEAR
MANUFACTURER'S GUARANTEE

1
LP
HP
0.5 Bar
take home today

Moselle monobloc

- Ceramic disc cartridge
- Swivel spout
- Easy to use twin lever controls
- Directional tap nozzle

Chrome finish 7612404001168 **£124**

BLANCO
GERMANY



5
YEAR
MANUFACTURER'S GUARANTEE

1
LP
HP
0.3 Bar
take home today

Spirex monobloc

- Ceramic disc cartridge
- Swivel spout
- Easy to use twin lever controls
- Ultra contemporary design

Chrome finish 5035889037323 **£135**
Next day delivery 5035889074564 **£135**

smeg



1
YEAR
MANUFACTURER'S GUARANTEE

5
YEAR
MANUFACTURER'S GUARANTEE

1
LP
HP
0.5 Bar
take home today

Modena monobloc

- Ceramic disc cartridge
- Swivel spout
- Easy to use twin lever controls
- Ultra contemporary design

Chrome finish 8017709160319 **£138**

GROHE
ENJOY WATER



5
YEAR
MANUFACTURER'S GUARANTEE

1
LP
HP
0.4 Bar
take home today

Ambi monobloc

- Ceramic disc cartridge
- Swivel spout with stop limiter
- Easy to use twin lever controls
- GROHE Starlight chrome finish

Chrome finish 4005176914102 **£148**

*Please note that mains water pressure can vary and may not always be sufficient for some taps.
If you are in any doubt, you can check your supply pressure using a water pressure gauge (available at B&Q).

All guarantees are manufacturer guarantees. This does not affect your legal rights.

how to shop • in-store • online www.diy.com • phone 0870 0101 006

▲ Our Banbury, Bedford, Burgess Hill, Bognor Regis, Consett, Eastleigh, Fareham, Hedge End, Nursing, Poole, Portsmouth, Port Glasgow and Sydenham stores stock a wide range of products – all available to take away. The Symbol is used throughout this Buying Guide to indicate the products that these stores stock. However these are subject to availability and ranges may vary by store.



Cesano monobloc

- Ceramic disc cartridge
- Swivel spout
- Easy to use twin lever controls
- Ultra contemporary design

Chrome finish 4055846 **£162**



Eiger monobloc

- ¼ Turn ceramic disc operation
- Swan neck swivel spout
- Easy to use twin lever controls
- Supplied with aerator

Chrome finish* 7612404002356 **£172**

Satin steel finish† 7612404002363 **£182**

*Available for home delivery and take home today.
†Available at selected stores and home delivery.



Olympus monobloc

- Ceramic disc cartridge
- Swivel spout
- Easy to use twin lever controls
- Ultra contemporary design

Chrome finish 7612404001182 **£173**



Bern monobloc

- ¼ turn ceramic disc valve operation
- Swivel spout
- Easy to use twin lever controls
- Ultra contemporary design

Chrome finish 7612980430291 **£195**



Mythos MTX monobloc

- Ceramic disc cartridge
- Swivel spout
- Easy to use twin lever controls
- Ultra contemporary design

Chrome finish 7612404002622 **£225**

Single lever taps



Montone single lever

- Ceramic disc cartridge
- Swivel spout
- Easy to use single lever control

Chrome finish* 5397007161793 **£35**

Next day delivery 4178118 **£35****

White† 5397007161816 **£45**

PVD stainless steel effect† 5397007161847 **£52**

Metallic black* 5397007161823 **£55**

*Available for home delivery and take home today.
**£5 delivery cost also applies
†Available at selected stores and home delivery.



Aso single lever

- Ceramic disc cartridge
- Swivel spout
- Easy to use single lever control

Chrome finish 5397007161984 **£62**



Get single lever

- GROHE SilkMove ceramic cartridge
- Swivel spout with stop limiter
- Easy to use single lever control
- GROHE starlight chrome finish

Chrome finish 4005176878862

Was £102 Now £58



Vipacco single lever

- Ceramic disc cartridge
- Swivel spout
- Easy to use single lever control

Chrome finish 4059066 **£103**

Metallic black 4059097 **£133**



Peak single lever

- Ceramic disc cartridge
- Swivel spout
- Easy to use single lever control

Chrome finish 5035889032397 **£104**

Next day delivery 5035889073901 **£104**



Get medium single lever

- GROHE SilkMove ceramic cartridge
- Swivel spout with stop limiter
- Easy to use single lever control
- GROHE starlight chrome finish

Chrome finish 4005176919787 **£117**

Side levers taps

FRANKE



Pro top single lever

- Ceramic disc cartridge
- Swivel spout
- Easy to use single lever control

Chrome finish 7612404000772 £139

COOKE & LEWIS



Saru side lever

- Ceramic disc cartridge
- Swivel spout
- Easy to use single lever control

Chrome finish 4059028 £78

COOKE & LEWIS



Natori side lever

- Ceramic disc cartridge
- Swivel spout
- Easy to use single lever control

Chrome finish 4055877 £83

COOKE & LEWIS



Ishikari side lever

- Ceramic disc cartridge
- Swivel spout
- Easy to use single lever control

Chrome finish 5320516 £98

COOKE & LEWIS



Gattola side lever

- Ceramic disc cartridge
- Swivel spout
- Easy to use single lever control
- Easy to install

Chrome finish 4055839 £124

GROHE
ENJOY WATER™



Feel side lever

- GROHE SilkMove ceramic cartridge
- Swivel spout with stop limiter
- Easy to use single lever control
- GROHE starlight chrome finish

Chrome finish 4005176847837 £137

BLANCO
GERMANY



Spire single lever

- Ceramic disc cartridge
- Swivel spout
- Easy to use single lever control
- Ultra contemporary design

Chrome finish 5035889036357 £142

Next day delivery 5035889073895 £142

COOKE & LEWIS



Rubicon side lever

- Ceramic disc cartridge
- Swivel spout
- Easy to use single lever control

Chrome finish 4055792 £147

smeg



Imola single lever

- Ceramic disc cartridge
- Swivel spout
- Easy to use single lever controls
- Ultra contemporary design
- Includes water saving cartridge

Chrome finish 8017709129040 £215



*Please note that mains water pressure can vary and may not always be sufficient for some taps. If you are in any doubt, you can check your supply pressure using a water pressure gauge (available at B&Q).

All guarantees are manufacturer guarantees. This does not affect your legal rights.

how to shop • in-store • online www.diy.com • phone 0870 0101 006

▲ Our **Nursbury, Bedford, Burgess Hill, Bognor Regis, Consett, Eastleigh, Fareham, Hedge End, Mursling, Poole, Portsmouth, Port Glasgow** and **Sydenham** stores stock a wide range of products – all available to take away. The symbol is used throughout this Buying Guide to indicate the products that these stores stock. However these are subject to availability and ranges may vary by store.

Pull-out / professional taps



Montone pull-out

- Ceramic disc cartridge
- Fixed spout
- Two mode pull-out spray

Chrome finish 5397007161854 **£57**



Saru pull-out

- Ceramic disc cartridge
- Swivel spout
- Easy to use single lever control
- Pull-out spray

Chrome finish 4059042 **£98**



Tronto spring neck

- Ceramic disc cartridge
- Swivel spout
- Easy to use single lever control
- Easy to install

Chrome finish* 4059158 **£105**
Metallic black† 4055891 **£125**

*Available for home delivery and take home today.
†Available at selected stores and home delivery.



Silaro spring neck

- Ceramic disc cartridge
- Swivel spout
- Easy to use single lever control
- Two spray modes

Chrome finish 4055815 **£127**



Mixa pull-out

- Ceramic disc cartridge
- Swivel spout
- Easy to use single lever control

Chrome finish 5035889032373 **£142**
Next day delivery 5035889074618 **£142**



Locone spring neck

- Ceramic disc cartridge
- Swivel spout
- Easy to use single lever control
- Two spray modes

Chrome finish 4059172 **£172**



Touch pull-out

- GROHE SilkMove ceramic cartridge
- Swivel spout with stop limiter
- Pull-out spray with trigger
- GROHE starlight chrome finish

Chrome finish 4005176836282 **£193**



Flair pull-out

- GROHE SilkMove ceramic cartridge
- Swivel spout with stop limiter
- Pull-out spray
- GROHE starlight chrome finish

Chrome finish 4005176836329 **£187**



Belfast pull-out

- Ceramic disc cartridge
- Swivel spout
- Easy to use single lever control
- Pull-out spray

Chrome finish 7612404002271 **£195**

Heritage taps



Newport monobloc

- Compression valve operation
- Swivel spout

Chrome finish* 5397007161861 **£52**

Chrome Next day delivery 4178125 **£52**

Antique brass finish† 5397007161878 **£54**



Chambley monobloc

- Quarter turn ceramic disc valve operation
- Swivel spout
- Easy to use twin lever controls

Chrome finish▲ 5341771 **£64**

Polished brass finish* 5341795 **£74**

Antique brass finish*▲ 5341788 **£74**

*Available for home delivery only.



Bonneville monobloc

- Compression valve operation
- Swivel spout
- Twin controls

Chrome finish 5326204 **£58**

Polished brass finish 5326211 **£68**

COOKE
& LEWIS

2
YEAR
MANUFACTURER'S GUARANTEE



2
LP
HP
0.2 Bar

Bonneville bridge mixer

- Compression valve operation
- Swivel spout
- Twin controls

Chrome finish	5326181	£97
Polished brass finish	5326198	£97

COOKE
& LEWIS

2
YEAR
MANUFACTURER'S GUARANTEE

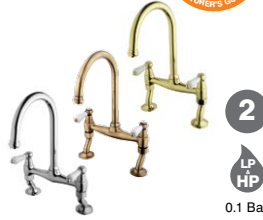

2
LP
HP
0.1 Bar

Chambley bridge mixer

- Quarter turn ceramic disc valve operation
- Swivel spout
- Easy to use twin lever controls

Chrome finish▲	5341740	£87
Polished brass finish*	5341764	£97
Antique brass finish*▲	5341757	£97

*Available for home delivery only.

Electronic taps



1
HP
1.0 Bar

Minta Touch electronic tap

- Innovative Touch technology
- Hybrid mixer, allows both, manual and electronic activation
- Touch mixer on the spout to turn it ON and OFF
- To determine temperature and flow rate, just activate your mixer via lever.

Chrome finish	4005176929830	£342
---------------	---------------	------

Clean and hygienic

Your mixer tap stays clean when your hands aren't. Start the faucet with your forearm or wrist to avoid cross contamination – it also keeps your mixer clean

Easy-to-use

A simple touch of the spout or body is all it takes to turn the mixer on or off.

A fusion of Design and Technology Invisible technology meets outstanding design.



1
HP
1.0 Bar

Bell Weir Electronic tap

- Electronic waterflow and temperature controls
- When turning bottom ring changes colour red on the hot and blue on cold

Chrome finish	4055808	£497
---------------	---------	------

simplifit®

EXCLUSIVE to B&Q

Saving valuable time and money

- Fit a new kitchen tap in just five easy steps
- Ideal for both DIY and professional tradesman
- Convenient above surface installation
- Two stop valves supplied
- Replace with an alternative simplifit® tap at any time using the same universal base

*Please note that mains water pressure can vary and may not always be sufficient for some taps. If you are in any doubt, you can check your supply pressure using a water pressure gauge (available at B&Q).

2
YEAR
MANUFACTURER'S GUARANTEE



1
HP
0.8 Bar

Bremen tap

- Ceramic disc cartridge
- Unique above sink installation
- Easy to use single lever control

Chrome finish	8000177122873	£68
---------------	---------------	-----

2
YEAR
MANUFACTURER'S GUARANTEE



1
LP
HP
0.5 Bar
take home today

Melbourne tap

- Ceramic disc cartridge
- Unique above sink installation
- Easy to use single lever control

Chrome finish	8000177122880	£87
---------------	---------------	-----

2
YEAR
MANUFACTURER'S GUARANTEE



1
HP
0.8 Bar

Zurich tap

- Quarter turn ceramic disc operation
- Unique above sink installation
- Easy to use single lever control

Chrome finish	8000177122903	£102
---------------	---------------	------

2
YEAR
MANUFACTURER'S GUARANTEE



1
LP
HP
0.5 Bar
take home today

Toronto tap

- Quarter turn ceramic disc operation
- Swivel spout
- Easy to use twin lever controls
- Unique above sink installation

Chrome finish	8000177122897	£105
---------------	---------------	------

All guarantees are manufacturer guarantees. This does not affect your legal rights.

▲ Our Banbury, Bedford, Burgess Hill, Bognor Regis, Consett, Eastleigh, Fareham, Hedge End, Nursing, Poole, Portsmouth, Port Glasgow and Sydenham stores stock a wide range of products – all available to take away. The symbol is used throughout this Buying Guide to indicate the products that these stores stock. However these are subject to availability and ranges may vary by store.

how to shop • in-store • online www.diy.com • phone 0870 0101 006

Filter taps



- Separate controls for hot, cold and BRITA filtered water
- Cartridge fits neatly under the sink
- Electronic cartridge exchange indicator
- Reduces limescale and chlorine for great tasting hot and cold drinks
- Free installation service included with all Brita dispensers



1

take home today

Sano filter tap

Chrome finish 4006387043735 **£182**

1

Dolce filter tap

Chrome finish 4006387043766 **£193**

1

take home today

Torlan filter tap

Chrome finish 8000177164965 **£267**

1

Kelda filter tap

Chrome finish ▲ 8000177164972 **£270**
Brush nickel effect 8000177164989 **£270**

don't forget...

Brita replacement cartridge

- Easy to fit
- 500 Litre cartridge

4006387029807 **£45**

Chilled water unit

in sink erator[®]
solutions for sinks



- Supplied with a dedicated cold water tap or you can team it with an InSinkErator HC1100 steaming hot water tap and have the best of both worlds 98°C hot and chilled filtered water at the touch of a lever



Chilled water dispenser

- Thermostat control – choose your temperature between 5 and 13°C
- Compact size (H34.5 x W19.5 x D29cm)
- High capacity of cold water supply 14-30L/h
- Supplied with cold water filter
- Rapid connections are used in the water circuit for an easy installation

Chrome finish 50375018766
Was £492 Now £392

WRAS
APPROVED
PRODUCT



Hot water dispensers

A hot water dispenser is the latest must-have for busy modern kitchens. With one of these, you won't need to clutter up worktop space with a kettle. These advanced taps deliver instant steaming hot water at any time.

- Energy efficient and economical – saves time and money
- Space saving compact design – no need for a kettle
- Enjoy up to 100 cups of steaming hot water per hour
- Easy to install into existing kitchens
- Adjustable temperature dial
- Compact and convenient
- Unique single handle (3300 model)
- Model 3300 features a hot push-lever locking mechanism
- 360°C Spout swivels for convenience
- Taps easily installed on either the work surface or the sink
- Easy replaceable filter



1

Instant 98°C hot water dispenser

- Instant 98°C hot water
- Water filter included
- Ergonomic design
- Time saving
- Auto hot shut-off lever
- Unobtrusive 2.5 litre tank fits under sink

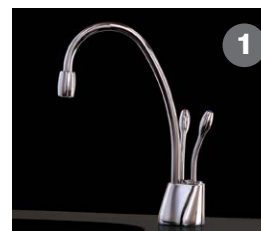
Chrome finish 94922880901
Was £378 Now £348

1

Hot and cold water dispenser

- Instant 98°C hot water
- Cold filtered water
- Water filter included
- Ergonomic design
- Time saving
- Auto hot shut-off lever
- Unobtrusive 2.5 litre tank fits under sink

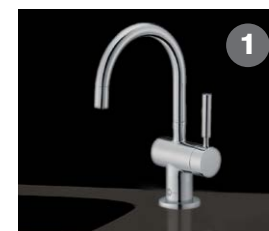
Chrome finish 94922880895
Was £425 Now £398

1

Model 3300 steaming hot water tap

Chrome finish 50375017028 **£498**

Model 3300 steaming hot/cold water tap

Chrome finish 50375017042 **£547**

smeg



This Smeg 3 in 1 tap combines style and convenience to suit your lifestyle, giving you the choice of 1. near boiling, 2. hot and 3. cold water instantly at your fingertips.

3 in 1 boiling tap

- 98°C near-boiling, hot & cold water
- Perfect for hot drinks & cooking
- Easy installation to existing plumbing
- Child safe lever for peace of mind

Chrome finish 8017709176365 **£694**

how it works...

It's as easy as 1, 2, 3...

1. 98°C near-boiling water from Smeg tank
2. Hot water from mains
3. Cold water from mains

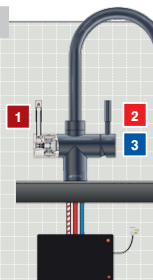

A PLACE FOR EVERYTHING

storage & accessories

A place for everything and everything in its place. Our range of storage solutions and accessories features some of the most innovative ideas for busy kitchens and modern lives.

Most of the storage solutions on the following pages are designed to fit **Cooke & Lewis** and **IT kitchens** base and larder units. For detailed compatibility information, see our Kitchen Price List.



1000 corner base unit



800 corner base unit



925 corner base unit



300, 400, 500, 600 base unit



300 larder units

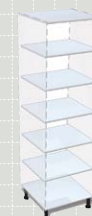

600 larder units

RETRO-FIT EXISTING CABINETS

easy-fit storage



3/4 Easy-fit carousel

- Fits 925mm corner base unit
- 1 Revolving shelf
- Fits directly onto top shelf or base of cabinet
- No central fixing pole allows more storage space on the trays
- Includes drilling guide and template

Compatible with:

Cooke & Lewis & IT kitchens

White & silver effect 5397007126587 **£78**

2 Revolving shelves shown



Easy-fit pull-out unit

- Fits 800 & 1000mm corner base units
- 1 Pull-out shelf
- Fits directly onto top shelf or base of cabinet
- Make products easy to reach

Compatible with:

Cooke & Lewis & IT kitchens

White & silver effect
RH 5397007118537 **£98**

White & silver effect
LH 5397007118544 **£98**

Right hand shown

don't forget...

It's easy to fit Easy-fit storage - see for yourself at youtu.be/ctCMVlqf-8k

Circular revolving units

3/4 carousel units



360° Full height revolving corner unit with carousel

- 890 x 890mm L shaped corner solution
- 5 Swivel shelves
- For use with standard height wall units (excluding Appleby kitchen)
- Includes door straps

Compatible with:
Cooke & Lewis & IT kitchens

Grey	4000280	£757
------	---------	-------------



3/4 Carousel

- Fits 925 x 925mm corner base unit
- 2 Swivel shelves

Compatible with:
Cooke & Lewis & IT kitchens

White	3232088	£50
-------	---------	------------



3/4 Carousel

- Fits 925 x 925mm corner base unit
- 2 Swivel shelves with silver effect sides and chrome rail detail

Compatible with:
Cooke & Lewis & IT kitchens

Silver effect	3595121	£77
---------------	---------	------------



3/4 Carousel

- Fits 925 x 925mm corner base unit
- 2 Swivel shelves with frosted glass effect sides and chrome rail detail

Compatible with:
Cooke & Lewis & IT kitchens

Silver effect	3595237	£87
---------------	---------	------------



3/4 Carousel

- Fits 925 x 925mm corner base unit
- 2 Swivel shelves
- Carousel storage without central pole

Compatible with:
Cooke & Lewis & IT kitchens

White & chrome effect	3882207	£262
-----------------------	---------	-------------

1/2 carousel units



1/2 Carousel

- Fits 800 & 1000mm corner base units
- 2 Swivel shelves with silver effect sides and chromed rail detail for use in blind corner unit

Compatible with:
Cooke & Lewis & IT kitchens

Grey & chrome effect	3595138	£62
----------------------	---------	------------



1/2 Carousel

- Fits 800 & 1000mm corner base units
- 2 Swivel shelves with frosted sides for use in blind corner unit

Compatible with:
Cooke & Lewis & IT kitchens

Frosted & chrome effect	3595244	£72
-------------------------	---------	------------

Pull and swing unit



Kidney shaped pull-out tray for corner unit

- Fits 1000mm corner base unit
- 2 Pull-out kidney shaped shelves with silver effect edging for use in blind corner units

Compatible with:

Cooke & Lewis & IT kitchens

White & chrome effect LH 3592113 **£175**

White & chrome effect RH 3592120 **£175**

Right hand shown

Pull and swing quad tray storage



Soft close pull and swing corner unit

- Fits 800 & 1000mm base units
- 2 Pull-out quad tray storage for blind corner units
- This product must be installed prior to installing the worktop

Compatible with:

Cooke & Lewis & IT kitchens

Silver effect 800mm LH 5397007118568 **£188**

Silver effect 800mm RH 5397007118551 **£188**

Silver effect 1000mm LH 5397007118780 **£188**

Silver effect 1000mm RH 5397007118575 **£188**

Right hand 1000mm shown



Pull and swing trays for corner unit

- Fits 1000mm base unit
- 2 Pull-out quad tray storage for blind corner units

Compatible with:

Cooke & Lewis & IT kitchens

Silver effect LH 3595107 **£265**

Silver effect RH 3595114 **£265**

Left hand shown



Soft close pull and swing trays for corner unit

- Fits 1000mm base unit
- 2 Pull-out quad tray storage with frosted glass sides for blind corner units

Compatible with:

Cooke & Lewis & IT kitchens

Silver effect LH 3595213 **£275**

Silver effect RH 3595220 **£275**

Left hand shown

Pull-out drawer tray systems



Pull-out trays

- Fits 300 & 500mm base units
- 2 Pull-out wire trays

Compatible with:

Cooke & Lewis & IT kitchens

Silver effect 300mm 4080343 **£26**

Silver effect 500mm 4080350 **£28**

Pull-out larder systems



Pull-out larder

- Fits 300 & 600mm larder tall units
- 4 Pull-out chrome storage baskets

Compatible with:

Cooke & Lewis & IT kitchens

Silver effect 300mm 4080329 **£110**

Silver effect 600mm 4080336 **£120**



Soft close pull-out larder

- Fits 300 & 600mm larder tall units
- 5 Pull-out chrome storage baskets

Compatible with:

Cooke & Lewis & IT kitchens

Silver effect 300mm 3340875 **£200**

Silver effect 600mm 3340882 **£260**



Soft close pull-out larder

- Fits 300 & 600mm larder tall units
- 5 Pull-out shelves with frosted glass sides

Compatible with:

Cooke & Lewis & IT kitchens

Silver effect 300mm 3595190 **£260**

Silver effect 600mm 3595206 **£295**



Soft close pull-out larder

- Fits 300 & 600mm larder tall units
- 5 Pull-out shelves with silver effect sides

Compatible with:

Cooke & Lewis & IT kitchens

Silver effect 300mm 3595084 **£260**

Silver effect 600mm 3595091 **£295**



Pull-out trays

- Fits 400mm base unit
- 2 Pull-out trays with silver effect sides

Compatible with:

Non-framed **IT kitchens** only

Silver effect 3595077 **£62**



Soft close pull-out tray

- Fits 500, 600 & 1000mm units
- 1 Pull-out tray with silver effect sides

Compatible with:
Cooke & Lewis & IT kitchens

Silver effect	500mm	3595015	£65
Silver effect	600mm	3595022	£72
Silver effect	1000mm	3595039	£78
Divider pack for pull-out tray		3595046	£20



Soft close pull-out tray

- Fits 500, 600 & 1000mm units
- 1 Pull-out tray with frosted glass sides
Sold individually

Compatible with:
Cooke & Lewis & IT kitchens

Silver effect	500mm	3595145	£68
Silver effect	600mm	3595152	£75
Silver effect	1000mm	3595169	£78
Divider pack for pull-out tray		3595176	£20



Soft close pull-out tray

- Fits 400mm base unit
- 2 Pull-out trays with frosted glass effect sides
- Door straps required 3095553

Compatible with:
Cooke & Lewis & IT kitchens

Silver effect	3595183	£65
---------------	---------	-----



Pull-out bottle storage

- Fits 400 & 500mm base unit
- Holds 16 bottles of wine
- Solid metal frame with inclined chrome racks and metal skin
- Not suitable for installing beneath a drawer

Compatible with:
Cooke & Lewis & IT kitchens

Silver effect & chrome effect	3595060	£100
-------------------------------	---------	------

Pull-out wicker baskets



Shelf mounted wicker basket

- Fits 500mm base or wall unit
- Wicker basket W450 x H375 x D220mm.
Sold singularly

Compatible with:
Cooke & Lewis & IT kitchens

Hand woven wicker	5124817	£20
-------------------	---------	-----



Pull-out wicker basket

- Fits 500mm base unit
- Wicker basket with solid frame and runners.
Sold singularly

Compatible with:
Non-framed **IT kitchens** only

Hand woven wicker	5052931072231	£40
-------------------	---------------	-----



Pull-out wicker basket

- Fits 500mm base unit
- Wicker basket with solid frame and runners.
singularly
- Not suitable for Chillingham range

Compatible with:
Cooke & Lewis

Hand woven wicker	3340783	£50
-------------------	---------	-----

FINISHING TOUCHES | tidy storage



Hanging storage rail

- L1000mm
- Includes 6 x 'S' hooks to hang utensils on
- Utensils not included

Chrome effect	5178315	£6
---------------	---------	----

'S' hooks

- Pack of 6
- For use with hanging storage rail

Chrome effect	5335138	£12
---------------	---------	-----



Multi-purpose hooks

- Pack of 6

Brushed nickel finish	5052931021116	£5
-----------------------	---------------	----

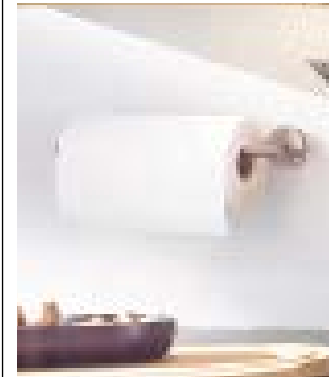

Wall mounted rod kitchen roll holder

Brushed nickel finish	3361054	£10
-----------------------	---------	-----

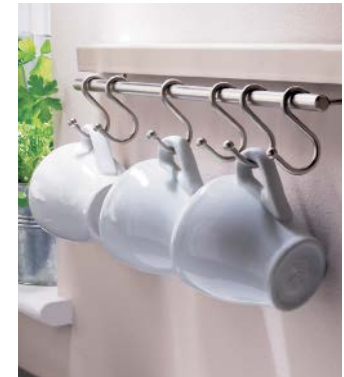

Premium mid-way rail with 6 hooks

- H40 x W377 x D30mm
- For use only in conjunction with Premium mid-way rail 3340646

Matt nickel finish	3340707	£10
--------------------	---------	-----



1. Premium mid-way rail

- W1000mm
- All premium mid-way accessories hang from this rail
- Includes mounting kit

Matt nickel finish 3340646 **£13**



2. Premium mid-way 3 tier towel holder

- W300 x H349 x D147mm
- For use with premium mid-way rail

Matt nickel finish 3340714 **£37**



Towel rails

- W112 x H467 x D31mm

Silver effect 5397007162424 **£20**



2. Kitchen roll holder

- W167 x H395mm

Matt nickel finish 5231973 **£8**



Pull-out detergent storage

- Fits 400, 500 & 600mm units
- Pull-out storage with adjustable clip in shelves
- Not suitable for installing beneath a drawer

Compatible with:
Cooke & Lewis & IT kitchens

Silver effect 3595053 **£60**



Pull-out ironing board

- Fits 500 & 600mm base units
- Board size 300 x 950mm
- Concealed behind a drawer front when not in use

Compatible with:
Non-frame **IT kitchens** only

White 3104200 **£65**



Soft close pull-out unit for accessories

- Fits 300mm base unit
- Pull-out utensils holder. Complete with knife block, chopping board and cutlery holder (cutlery & utensils not included)

Compatible with:
Cooke & Lewis & Non-frame IT kitchens

Chrome effect 3882214 **£100**

Wooden utensil trays



Wooden pull-down utensil tray

- Supplied with utensils

Compatible with:
Cooke & Lewis & IT kitchens

Solid beech 600mm 3340639 **£68**



Wooden utensil tray

- Supplied with utensils

Compatible with:
Non-framed **Cooke & Lewis** kitchens only

Solid beech Fits 600mm drawer 3340622 **£97**

Wooden cutlery trays



Wooden cutlery tray

Compatible with:
Framed **Cooke & Lewis** kitchens only

Solid beech Fits 500mm inset drawer 3340455 **£54**

Solid beech Fits 600mm inset drawer 3340462 **£64**

Compatible with:
Non-framed **Cooke & Lewis** kitchens only

Solid beech Fits 500mm drawer 3340615 **£54**

Solid beech Fits 600mm drawer 3340608 **£64**

Cutlery trays



Cutlery tray 

Compatible with:
Non-framed **IT kitchens** only

Fits 300mm standard drawer	3361092	£7
Fits 400mm standard drawer	3361122	£8
Fits 500mm standard drawer	3361108	£9
Fits 600mm standard drawer	3361115	£11



In-frame cutlery tray 

Compatible with:
Framed **IT kitchens** only

Fits 500mm drawer ▲	3896013	£13
Fits 600mm drawer	3896020	£14
Fits 800mm drawer	3896037	£18



Prestige deep cutlery tray 

Compatible with:
Non-framed **IT kitchens** only

Fits 500mm prestige drawer ▲	3447024	£13
Fits 600mm prestige drawer ▲	3447017	£14
Fits 800mm prestige drawer ▲	3447031	£20



Cutlery tray 

Compatible with:
Cooke & Lewis

Fits 500mm drawer ▲	3452097	£28
Fits 600mm drawer	3452080	£38
Fits 800mm drawer	3451946	£43

Accessories



Sink cabinet liner 

■ Fits 1000mm base cabinet

Compatible with:
Cooke & Lewis & Non-framed **IT kitchens** only

Stainless steel effect	3340868	£15
------------------------	---------	------------



Baking tray holder 

■ Fits 400, 500, 600mm base units
■ H180 x W130 x D352mm
■ Can be installed vertically or horizontally

Compatible with:
Cooke & Lewis & **IT kitchens**

Chrome	5397007128710	£20
--------	---------------	------------



Plinth heater 

■ Minimum plinth height 100mm
■ With variable heat settings and fan only setting for air circulation in warm weather
■ Front panel switch for turning on or off
■ Automatic safety cut-out
■ Fitted with 2.2m mains lead, bare ended

2kW Model	4077411	£97
-----------	---------	------------

Pick up a copy of our...
'you can do it' book

The complete step-by-step book of Home Improvement



For more
ideas and know-how
visit diy.com/advice





take
home
today

Swing-out bin



- Fits 400, 500, 600mm base units
- Height 320mm
- Capacity 10 litres
- Lid lifts automatically as door opens
- Integral, lift-out bucket

Compatible with:
Cooke & Lewis & Non-frame **IT kitchens**

Stainless steel effect 3039601 **£20**



2 Pull-out recycling waste bins



- Fits 400, 500, 600mm base units
- Height 386mm
- Capacity 32 litres
- 2 Plastic waste bins in a chromed slide-out rack

Compatible with:
Cooke & Lewis & **IT kitchens**

Grey 3592137 **£55**



In-drawer waste bin set



- Fits 600mm base unit
- Height 286mm
- Capacity 39 litres
- 4 in 1 Recyclable waste bins

Compatible with:
Cooke & Lewis & Non-frame **IT kitchens**

Grey 5397007107708 **£99**



take
home
today

Glass cabinet shelves



- Clear glass
- Pack of 2

Compatible with:
IT kitchens

W266 x D247mm	5291762	£15
W466 x D247mm	5291755	£17
W567 x D247mm	5291779	£18
W967 x D247mm▲	5291786	£27



Glass cabinet shelves



- Clear glass
- Pack of 2

Compatible with:
Cooke & Lewis

W258 x D280mm	5291793	£15
W458 x D280mm▲	5291809	£18
W558 x D280mm	5291816	£20

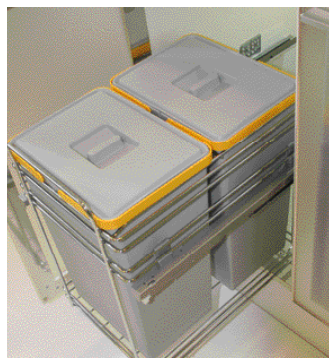

2 Pull-out recycling waste bins



- Fits 300 & 400mm base units
- Height 515mm
- 2 plastic waste bins in a chromed slide-out rack

Compatible with:
Cooke & Lewis & Non-frame **IT kitchens**

Grey 300mm 40ltr 5397007035223 **£90**
Grey 400mm 48ltr 5397007035247 **£99**



2 Pull-out recycling waste bins



- Fits 500mm base unit
- Height 515mm
- Capacity 48 litres
- 2 plastic waste bins in a chromed slide-out rack

Compatible with:
Cooke & Lewis & **IT kitchens**

Grey 5397007035261 **£134**



4 Pull-out recycling waste bins



- Fits 600mm base unit
- Height 515mm
- Capacity 78 litres
- 4 plastic waste bins in a chromed slide-out rack

Compatible with:
Cooke & Lewis & **IT kitchens**

Grey 5397007035681 **£152**



Cabinet shelf supports



- For use inside cabinets
- Pack of 8

3232484 **£2**



Illuminated shelf light



- W458 x D280mm
- Compatible with: **Cooke & Lewis**

Clear glass	3821343	£55
-------------	---------	-----

- W466 x D247mm
- Compatible with: **IT kitchens**

Clear glass	3821336	£58
-------------	---------	-----



Illuminated shelf light



- W600 x D280mm

Compatible with:

- **Cooke & Lewis** & **IT kitchens**

Metallic	3500347	£47
----------	---------	-----



Modern cast shelf brackets



- W110 x H20 x D232mm
- Pack of 2

Brushed steel finish	3096109	£10
----------------------	---------	-----

Metallic steel effect	3096116	£11
-----------------------	---------	-----



Curved rod shelf brackets



- W180 x H210 x D20mm
- Pack of 2

Brushed nickel finish	3096192	£11
-----------------------	---------	-----



Slatted wood shelf



- W500 x D220 x H16mm
- For use with all bracket types

Solid oak	5049424	£14
-----------	---------	-----



Shelf supports



- Bracket size W39 x D108 x H120mm
- Suitable for shelves 5-32mm thick
- Pack of 2

Brushed nickel effect	3360200	£10
-----------------------	---------	-----



Silver effect rod shelf



- W471 x D220 x H16mm
- Must be used with modern cast shelf brackets (sold separately)

Silver effect	3096147	£12
---------------	---------	-----



Shelf supports



- Suitable for glass shelves up to 2-20mm thick
- Can also be used with slatted wooden shelves
- Pack of 2

Brushed nickel effect	3231708	£9
-----------------------	---------	----

Glass shelves



- W451 x D220mm
- For use with shelf supports below

Clear glass	5291748	£10
-------------	---------	-----

OPT FOR A
BRIGHT LIGHT OR
SUBTLE GLOW

halogen lights



Single wedge light

- For use beneath wall cabinets
- Includes interconnecting cables, transformer, mains lead and fixing set
- Pack of 2

Brushed steel effect
W80 x H142 x D75mm 3360057 **£20**

Double wedge light

- 20W
- For use beneath wall cabinets
- Includes interconnecting cables, transformer, mains lead and fixing set

Brushed steel effect
W450 x H142 x D75mm 3360064 **£28**

Switched socket uni

- For use beneath wall cabinets

Brushed steel effect
W140 x H142 x D75mm 3360071 **£21**



Low voltage spotlight

- 10W
- Pack of 4 (internal)
- Can be surface mounted or recessed beneath wall cabinets or inside glass fronted cabinets
- Includes transformer and bulbs

Chrome effect
W70 x H19 x D70mm 3231975 **£28**



Modern under light

- 10W
- Pack of 3
- For use beneath wall cabinets
- Includes transformer

Stainless steel effect
W130 x H13mm 3362204 **£34**

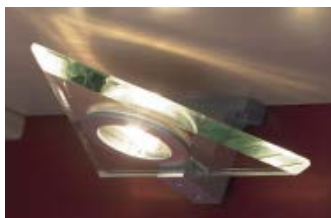

Triangular glass light

- 12v / 20W
- Pack of 3
- Includes transformer

W176 x H62 x D196mm 3598092 **£47**



Frosted wedge light

- 20W
- Pack of 2
- Includes transformer

Stainless steel / frosted glass
W150 x H115mm 3360040 **£22**



Round glass light

- 12v / 20W
- Pack of 3
- Includes transformer

W150 x H62 x D150mm 3598085 **£47**



Modern over light

- 20W
- Pack of 3
- For use with wall cabinets
- Includes transformer

Stainless steel effect
W330 x D155mm 3363867 **£37**

fluorescent lights



Fluorescent light

- 6W, 10W, 16W and 20W
- For use beneath wall cabinets
- Includes interconnecting cable, mains lead, fixing brackets and fluorescent tube

6W
Fits under all wall cabinets
W270 x H19 x D45mm 3232095* **£15**

10W
Fits under 400mm and larger wall cabinets
W396 x H19 x D45mm 3232118† **£17**

16W
Fits under 600mm and larger wall cabinets
W524 x H19 x D45mm 3232149* **£18**

20W
Fits under 800mm and larger wall cabinets
W623 x H19 x D45mm 3231937† **£18**

* Available for home delivery and take away today.
† Available for home delivery and at selected stores.



Fluorescent under light

- 8W and 13W
- For use beneath 400mm and larger wall cabinets, includes fitting kit and fluorescent tube
- 8W. Silver effect

W340 x H21 x D71mm 3360217 **£22**

13W. Silver effect
W570 x H21 x D71mm 3360323 **£23**



Illuminated shelf light

- For surface mounting
- With integral switch and 8mm thick frosted, tempered glass
- Includes screw fixings

Anodised aluminium with glass
600mm 3500347 **£47**

shop
online...

Shop from the comfort
of your own home.
Visit www.diy.com





Battery operated LED light

- Built in sensor with 50-100mm range activated by drawer opening and closing
- For surface mounting
- Includes self-adhesive tape
- Powered by 4 x AAA batteries, not included

Satin chrome finish
W305 x H14 x D17mm 3882177 **£17**



Round LED light

- 12v / 0.84W
- Pack of 3
- Includes transformer

L70 x W70 x H20mm 3596012 **£35**



Small flat round LED light

- 3 x 12W spotlights

Stainless steel effect
L73 x W58 x H6mm 3820827 **£42**



LED cabinet lights

- 3 x 1.4W LED spotlights
- Can be surfaced mounted or recessed

Stainless steel effect
L73 x W72 x H24mm 3820834 **£44**



Triangular LED light

- 3 x 1.4W LED cabinet lights

Stainless steel effect
L140 x W140 x H50mm 3820841 **£44**



Wedge LED light

- 3 x 1.4W LED cabinet lights

Stainless steel effect
L150 x W83 x H70mm 3820858 **£48**



Rectangular LED lights

- Set of 3

Aluminium effect
W150 x H10 x D25mm 3882160 **£54**



LED plinth light

- 10 x 12v
- Pack of 10
- Includes transformer

Stainless steel effect
15 x 15mm 3592168 **£67**

LED plinth light – blue

- 10 x 12v
- Pack of 10
- Includes transformer

Stainless steel effect
15 x 15mm 3592175 **£68**



LED strip lights – bendy pack

- 4 x 12v / 0.8W
- 300mm per strip
- Pack includes driver lead, connecting lead, transformer and distributor block

Clear effect L300 x W8 x H6mm
3820865 **£57**

Spare bendy lights

- 3 x 12v / 0.8W bendy lights

Clear effect L300 x W8 x H6mm
3820872 **£21**

Doing your bit

Replace halogen downlighters in your kitchen with an equivalent LED bulb to save around £4/year per bulb, even better you will only need to replace them every 15 years.

Source EST.



KEY
FEATURES
TO LOOK
FOR IN

single ovens

Sourced from the world's leading manufacturers, our range features some of the most stylish designs and advanced cooking technologies available. Our useful symbols shown below will help you choose.



LED programmable timer

Ensure every dish is cooked to perfection – choose an oven with a programmable timer.

Self-cleaning ovens!

Some of our ovens are **pyrolytic** and use the ultimate in self-cleaning technology. Protected by an automatic locking, quadruple-glazed door, the oven heats up inside to 500°C to burn off any grease or dirt in no time at all.



Large viewing window

Allows you to see what you are cooking and a double glazed door ensures the outer temperature never gets too hot to touch.

Catalytic stay clean liners

Featured in some ovens, these break down grease or spilled food when used on a high heat setting. The next best thing to pyrolytic.



Interior light

All our ovens come with interior lights either fitted at the back, top or sides.



Choose your finish

We offer different colours and finishes across the range including black, stainless steel, white glass or brushed steel to complement your kitchen style.

symbols guide...

Which type of cooking?

Different types of oven distribute the heat in different ways. There are 3 main options:

Fan oven

A fan at the back continuously circulates hot air for a more even heat distribution, which can cook more quickly.

Conventional oven

Heating elements at the top and bottom circulate hot air naturally, creating varying temperatures – perfect for the Sunday roast!

Multifunction oven

Fan and conventional cooking in one oven. Plus, they offer a range of functions such as defrosting and rotisserie style/fan assisted grilling.

10 Cooking functions

How many does a cook need? Some of our ovens have more than others including functions such as 'defrost' and 'gratin'.

65ltr MAIN 30ltr TOP Oven capacity

Our ovens range from 53 to a massive 72 litres. 'Top' applies to the capacity of the second oven, normally used for cooking and grilling, in double ovens only.

Grilling

Provides fast cooking and virtually instant heat, perfect for browning meats quickly. Some ovens offer full or half grill options, whilst some include a fan for a more even cooking result.

Grilling

Fan grilling

Half grill

Fan with half grill

Energy efficiency



These symbols tell you how energy efficient each appliance is with 'A' being the most efficient and 'D' being the least.

25 AMP Electrical connection

This symbol indicates the power supply in amps. This is a guideline only; speak to a qualified electrician.

Manufacturers' guarantees



Every appliance is covered by a manufacturer's guarantee for parts and labour. This varies according to the brand and the model.

Your legal rights are not affected. Please see individual manufacturers' websites for guarantee details.

cataC EXCLUSIVE to B&Q



Single conventional oven
H59.5 x W59.4 x D49.8cm



- Easy clean enamel
- Double glazed door
- Minute minder

EOVSV2 Stainless steel 8422248603348 **£123**

cataC EXCLUSIVE to B&Q



Single fan oven
H59.3 x W59.7 x D59.5cm



- Easy clean enamel
- Minute minder
- Defrost setting
- 1 Shelf, 1 baking tray, trivet and handle

EF60SS2 Stainless steel 8422248600293 **£205**

COOKE & LEWIS EXCLUSIVE to B&Q



Single multifunction oven
H59.7 x W59.7 x D49.8cm



- Easy clean enamel
- Minute minder
- Double glazed door
- 1 Shelf, 1 baking tray, trivet and handle

CLEF2SS-C Black/stainless steel 5052931055678 **£213**

COOKE & LEWIS EXCLUSIVE to B&Q



Single oven ▲
H59.5 x W59.5 x D48.5cm



- Easy clean enamel
- Double glazed door
- 1 Shelf, 1 baking tray, trivet and handle
- Lower element is used to crisp the base of food such as pizza

CLE01BK-C Black/stainless steel 5052931055685 **£213**

COOKE & LEWIS EXCLUSIVE to B&Q



Single oven ▲
H59.3 x W59.7 x D48.7cm



- Easy clean enamel
- Minute minder
- Defrost setting
- 1 Shelf, 1 baking tray, trivet and handle

CLMF1BK-C Black/stainless steel 5052931055661 **£273**

Indesit EXCLUSIVE to B&Q



Single multifunction oven
H60 x W60 x D54.5cm



- Easy clean enamel
- Digital display
- Multilevel function reduces certain food smells from mixing when cooking on two racks

BIMS53KABIXGBS Stainless steel 8007842805215
Was £278 Now £269

COOKE & LEWIS EXCLUSIVE to B&Q



Single fan oven
H59.5 x W59.5 x D50cm



- Easy clean enamel with catalytic liners
- LED programmer/timer
- Defrost setting
- 1 Shelf, 1 baking tray, trivet and handle

CLMF2BK-C Black/stainless steel 5052931055586 **£283**

cataC EXCLUSIVE to B&Q



Single fan oven
H59.5 x W59.5 x D48.5cm



- Easy clean enamel
- LED programmer/timer
- Defrost setting
- 1 Shelf, 1 baking tray, trivet and handle
- Lower element is used to crisp the base of food such as pizza

EFGM60SS2 Stainless steel 8422248600279 **£294**

COOKE & LEWIS **EXCLUSIVE to B&Q**



Single oven ▲
H59.5 x W59.5 x D48.5cm



- Easy clean enamel
- LED programmer/timer
- Defrost setting
- 1 Shelf, 1 baking tray, trivet and handle

CLEF3SS-C Black/stainless steel 5052931055654 **£302**

COOKE & LEWIS **NEW & EXCLUSIVE**



Single multifunction oven
H59.4 x W59.4 x D54.5cm



- Adjustable telescopic shelf
- Twin lights
- Electric touch control LED display
- Triple glazed door
- Easy clean blue enamel

CLSMO-60 Mirror finish blk & S/steel 5052931258758 **£302**

Indesit **EXCLUSIVE to B&Q**



Single multifunction oven
H60 x W60 x D54.5cm



- Multilevel function reduces certain food smells from mixing when cooking on two racks
- Digital display
- Nero glass finish - matching hobs available

IFG63KANR Stainless steel/black 8007842793680
Was £354 Now £299

BOSCH



Single fan oven
H59.5 x W59.5 x D54.8cm



- Hotair - perfect results thanks to optimal distribution
- Defrost function ■ LED display ■ Child lock
- Telescopic rail available, see page 89

HBN331S2B Black 4242002774121 **£346**
HBN331E2B Brushed steel 4242002774114 **£346**

BEKO **EXCLUSIVE to B&Q**



Single fan oven
H59.5 x W59.4 x D56.7cm



- LED full programmer
- Nano coating on inner doors for easy clean
- Stylish push in push out knobs
- Fully removable inner glass door for easy clean
- Defrost function ■ Cooking tray

QOF243B Black 5023790032223 **£355**

BEKO **EXCLUSIVE to B&Q**



Single multifunction oven
H59.5 x W59.4 x D56.7cm



- Catalytic stay clean liners ■ LED full programmer
- Nano coating on inner doors for easy clean
- 1 full extensions telescopic system
- Stylish push in push out knobs
- Fully removable inner glass for door for easy clean
- Defrost function ■ Cooking tray

QOM243B Black 5023790032230 **£398**

Hotpoint **EXCLUSIVE to B&Q**



Single multifunction oven ▲
H60 x W60 x D57cm



- 6 Level multifunction including gratin, pastries and pizza functions
- Easy to use digital timer
- Catalytic stay clean liners

SBS638CXs Stainless steel 5016108808337 **£403**

smeg **EXCLUSIVE to B&Q**



Single multifunction oven
H58.8 x W59.7 x D57cm



- LED display
- Removable inner glass doors
- Pizza accessories available, see page 86

SF371X Stainless steel 8017709171445 **£405**

BOSCH

Single fan oven
H59.5 x W59.5 x D55cm



- Hotair – perfect results thanks to optimal distribution
- Defrost function
- LED display
- Child lock
- Telescopic rail available, see page 89

HBA13B253B Brushed steel 4242002691497 **£400**

COOKE & LEWIS
NEW & EXCLUSIVE

Dual Zone



Single dual zone oven
H59.4 x W59.4 x D54.5cm



- Dual cooking zones
- Defrost function
- Twin lights
- Electronic touch control LED display
- Triple glazed door
- Easy clean blue enamel

CLDZO-60 Mirror finish blk & S/steel 5052931258765 **£445**

BEKO
EXCLUSIVE to B&Q

Single multifunction touch control oven
H59.5 x W59.5 x D56.7cm



- Catalytic stay clean liners
- Touch control fully programmable timer
- Soft close door
- Nano coating on inner glass door for easy clean
- Full extension telescopic system
- Fully removable inner glass door
- Defrost function

QOM246B Black 5023790032247 **£482**

Single gas ovens

CATA C
EXCLUSIVE to B&Q

Single gas oven
H59.4 x W59.4 x D54.3cm



- Easy clean enamel
- Minute minder
- Triple glazed door
- 1 Shelf, 1 baking tray, trivet and handle

OVG60SS Stainless steel 8422248604574 **£302**

smeg

Single gas oven
H59.2 x W59.7 x D57cm



- Cirogas oven with fan
- Electric grill
- 8 Cooking functions

SF341GVX Stainless steel 8017709162771 **£503**

oven

accessories...

See below for additional accessories that enhance your cooking experience and help to make life a little easier!

BOSCH

A handy 3-fold telescopic internal oven drawer that fully extends, allowing you to pull out baking trays, wire shelves or universal pans for easy access. No more reaching into the oven!

HEZ338357	Telescopic rail	4242002686011	£134
------------------	-----------------	---------------	-------------

smeg

A pizza stone at the base of the oven above the lower element allows you to cook pizza evenly in just 3-5 minutes. Excellent too for cooking focaccia bread, savoury flans and fish or vegetables in foil, that won't dry up but stay moist.

PRTX	Refractory pizza stone with handles	8017709081232	£72
PALPZ	Pizza shovel with fold away handle	8017709133917	£63

Single pyrolytic ovens

smeg EXCLUSIVE to **B&Q**



Single multifunction oven
H59.2 x W59.7 x D57cm

2yr PARTS 2yr LABOUR

- Pyrolytic self-cleaning oven
- LED display
- 5 Cooking shelf positions
- Pizza accessories available, see page 96

SFP372X Stainless steel 8017709165710 **£452**

Hotpoint



Single oven
H60 x W60 x D57cm

5yr PARTS 1yr LABOUR

- Pyrolytic self-cleaning oven
- 8 Level multi-function single oven including pizzas, pastries and proving functions
- Fast clean pyrolytic cycle
- Electronic programmable timer

SH89PXS Stainless steel 5016108804667 **£525**

BEKO EXCLUSIVE to **B&Q**



Pyrolytic single oven
H59.5 x W59.4 x D56.7cm

2yr PARTS 2yr LABOUR

- Pyrolytic self-cleaning oven
- Touch control fully programmable timer
- Soft close door
- Full extension telescopic shelf
- 2 x self cleaning programmes
- Defrost function
- Fully removable inner glass door
- Cool door technology with four layers of glass

QOM396B Black 5023790032254 **£597**

BOSCH



Single multifunction oven
H59.5 x W59.5 x D54.8cm

2yr PARTS 2yr LABOUR

- Pyrolytic self-cleaning oven
- Hotair – perfect results thanks to optimal distribution
- Accurate temperature control 50-300°C
- LED display
- Telescopic rail available, see page 89

HBA63B251B Brushed steel 4242002675022 **£678**

B&Q Homefit
APPROVED tradesmen - fixed prices

Hard Flooring*

All types wooden, engineered and laminate flooring

from
£18
per sq.m.
Subject to survey

Carpet & Vinyl

All carpets and vinyl

from
£6
per sq.m.
Subject to survey

Tiling*

All types of wall and floor tiles

from
£39
per sq.m.
Subject to survey

Plumbing & Heating*

All systems general plumbing and replacement

Radiators & Heated Towel Rails

from
£149
per sq.m.
Subject to survey

Boilers*

from
£1649
Subject to survey

Electrics*

General wiring, circuits, lighting and appliance installations

from
£69
Subject to survey

Lock Replacement

Any lock, any door (internal/external), safes

from
£39
Subject to survey

Tap Replacement

Bathroom, kitchen, utility, ensuite and outside

from
£49
Subject to survey

Alarm Replacement

from
£99
Subject to survey

For a **B&Q Homefit** approved tradesman call:

01236 634557

Lines open: **Mon-Fri: 08.30-20.00**

Sat: 09.00-17.00 Sun: 10.00-16.00

KEY FEATURES TO LOOK FOR IN

double ovens

A double oven gives you extra space to cook larger meals and combinations of food. Being able to use both ovens on completely separate temperatures gives you lots of flexibility.



LED programmable timer

Ensure every dish is cooked to perfection – choose an oven with a programmable timer.



Main oven **65ltr** MAIN

This has the largest capacity and is always the lower of the two ovens. Check out the symbols next to each product to find ovens that offer conventional, fan or multifunctional cooking.

Top oven **30ltr** TOP

With a smaller capacity than the main oven, the top oven offers extra space for cooking. Some include a fan for a more even cooking result. Top ovens also include a separate grill - look out for full or half grill options.

Catalytic stay clean liners

When used at a high heat, ovens with a catalytic liner break down the grease in any food spilt onto them – making cleaning less of a chore.



Built under or eye level?

Built under: the most conventional choice, fitting neatly under a worktop with or without a housing depending on brand (see oven features for details).

Eye level: fitted in a tall oven housing

All guarantees are manufacturer guarantees. This does not affect your legal rights.

Built under double ovens

COOKE & LEWIS



A **30** AMP **32.5ltr** TOP **45ltr** MAIN **4** [Icons: Fan, Grill, Defrost]

Built under double oven
H71.8 x W59.4 x D58.1cm

2yr PARTS 2yr LABOUR

- LED programmer timer
- Easy clean enamel
- Interior light
- Defrost function

CLDMO-35 Black & S/steel 5052931284597 **£397**

COOKE & LEWIS **NEW & EXCLUSIVE**



A **30** AMP **32.5ltr** TOP **45ltr** MAIN **8** [Icons: Fan, Grill, Defrost, Telescopic Shelf, Twin Lights]

Built under double oven
H71.8 x W59.4 x D56cm

5yr PARTS 2yr LABOUR

- Telescopic shelf main oven
- Defrost function
- Twin lights main oven
- Easy clean blue enamel
- Electronic touch control LED display
- Triple glazed door

CLDO-72 Mirror finish blk & S/steel 5052931258574 **£457**

Built under double ovens

INDESIT



B 20 AMP 37ltr TOP 59ltr MAIN 3

Built under fan double oven
H87 x W59.7 x D57.8cm

5yr PARTS 1yr LABOUR

- Digital interface
- Catalytic stay clean liners
- Doesn't require housing

FIMU21X3S Stainless steel 8007842805161
Was £502 Now £449

Hotpoint

EXCLUSIVE to **B&Q**



B 18 AMP 33ltr TOP 59ltr MAIN 5

Built under multifunction double oven ▲
H87 x W59.7 x D57.8cm

5yr PARTS 1yr LABOUR

- Solarplus twin variable grill
- Easy to use digital timer
- Catalytic stay clean liners
- Doesn't require housing

UBS537CX5 Stainless steel 5016108805480 **£534**

Eye level double ovens

COOKE & LEWIS



A 30 AMP 32.5ltr TOP 56ltr MAIN 4

Eye level double oven
H88.8 x W59.6 x D56cm

2yr PARTS 2yr LABOUR

- LED programmer timer
- Easy clean enamel
- Interior light
- Defrost function

CLBUEDB-95 Black & S/steel 5052931284603 **£429**

INDESIT

EXCLUSIVE to **B&Q**



A 20 AMP 39ltr TOP 71ltr MAIN 4

Eye level fan double oven
H88.7 x W59.7 x D57.5cm

5yr PARTS 1yr LABOUR

- Digital display
- Catalytic stay clean liners

BIMDS23BIX5 Stainless steel 8007842805253 **£435**

BOSCH



A 20 AMP 35ltr TOP 56ltr MAIN 4

Built under fan double oven
H71.7 x W59.5 x D55cm

2yr PARTS 2yr LABOUR

- Hotair – perfect results thanks to optimal distribution
- Defrost function
- LED display
- Catalytic back liner
- Doesn't require housing
- Telescopic rail available, see page 89

HBN13B251B Brushed steel 4242002498768 **£768**
HBN13B261B Black 4242002486116 **£768**

smeg



A 30 AMP 36ltr TOP 63ltr MAIN 10

Built under fan double oven
H71.7 x W59.7 x D57cm

2yr PARTS 2yr LABOUR

- 6 and 4 functions
- LED display
- Doesn't require housing
- Circulaire - no preheat when cook time is 20mins+ and no flavour transfer when cooking different foods at the same time
- Air cooling system ensures a safe surface temperature
- Pizza accessories available, see page 89

DUSC36X Stainless steel 8017709149659 **£895**

COOKE & LEWIS

NEW & EXCLUSIVE



A 30 AMP 32.5ltr TOP 56ltr MAIN 8

Eye level double oven
H88.8 x W59.4 x D56cm

5yr PARTS 2yr LABOUR

- Telescopic shelf main oven
- Defrost function
- Twin lights main oven
- Easy clean blue enamel
- Electronic touch control LED display
- Triple glazed door

CLDO-90 Mirror finish blk & S/steel 5052931258567 **£497**

Hotpoint

EXCLUSIVE to **B&Q**



A 18 AMP 39ltr TOP 74ltr MAIN 5

Eye level fan double oven
H88.7 x W59.7 x D57.7cm

5yr PARTS 1yr LABOUR

- Easy to use digital timer
- Catalytic stay clean liners

DBS539CX5 Stainless steel 5016108805442 **£505**

DBS539CK5 Black 5016108805473 **£505**

COOKE & LEWIS **NEW & EXCLUSIVE**

True double oven



Eye level double oven
H107.7 x W59.4 x D56cm

- Two full sized cavities
- Defrost function
- Twin lights
- Easy clean blue enamel
- Electronic touch control LED display
- Triple glazed door
- Telescopic shelf

CLDO-108 Mirror finish blk & S/steel 5052931258550 **£597**

BEKO **EXCLUSIVE to BAO**



Eye level multifunction oven
H89 x W59.4 x D56.7cm

- Catalytic stay clean liners
- Fully programmable touch control timer for main oven
- Soft closes door main oven
- Push in push out knobs
- Fully extension telescopic shelf

QDM246B Black 5023790032261 **£598**

smeg



Eye level multifunction double oven
H88 x W59.7 x D56.7cm

- LED display
- Fully programmable
- Pizza accessories available, see page 89

DOSC34X Stainless steel 8017709149673 **£653**

BOSCH



Eye level fan double oven
H88.8 x W59.5 x D55cm

- Hotair – perfect results thanks to optimal distribution
- Catalytic back liner
- Extra large capacity oven with grey enamel (lower oven)
- Telescopic rail available, see page 89

HBM13B261B Black 4242002486086 **£712**

HBM13B251B Brushed steel 4242002498737 **£712**

BOSCH



Warming drawer
H14.1 x W59.4 x D54.4cm



HSC140P51B Brushed steel 4242002487700 **£390**

COOKE & LEWIS



Warming drawer
H14.1 x W59.4 x D54.4cm



- To match Cooke and Lewis ovens
- Temperature setting
- Anti slip mat

CLWD140 Brushed steel 5052931258802 **£258**

Double pyrolytic ovens

smeg



Pyrolytic eye level double oven
H88 x W59.7 x D54.5cm

- LCD Display
- Pyrolytic cleaning
- Easy clean enamel

DOSP38X Stainless steel 8017709186500 **£897**

All guarantees are manufacturer guarantees. This does not affect your legal rights.

KEY
FEATURES
TO LOOK
FOR IN

microwave ovens



Perfect for meals in minutes, some of our microwave ovens feature grills, fan ovens and automatic programmes. Look out for built in or freestanding models and use our symbols guide to help you choose.

symbols guide...

65ltr MAIN Microwave capacity

Our microwaves range from 20 to 36 litres.

9 Power levels

Giving you the power, check out the number of levels for varying degrees of flexibility. Power levels allow you to fine tune or adapt your recipes – various types of food will require different power levels.

800w 800w GRILL Output

Measured in Watts, from 800w to 1000w, the wattage determines the speed with which your microwave will cook. Generally the larger the capacity of the microwave oven, the higher the wattage will be.

⊕ Fan oven function?

The fan oven function allows you to use your microwave as a conventional oven. The fan oven function makes roasting and baking possible as air is circulated inside the cavity.

QS Quick start

When speed is of the essence, the quick start function lets you begin heating with the touch of a button. The microwave starts on full power for a pre-determined time.

🔒 Child safety

For safety first, microwaves with this feature allow you to lock the oven so that tiny fingers can't open or operate it without your knowledge.

Manufacturers' guarantees

2yr PARTS 2yr LABOUR

Every appliance is covered by a manufacturer's guarantee for parts and labour. This varies according to the brand and the model. Your legal rights are not affected. Please see individual manufacturer's websites for guarantee details.

cata **EXCLUSIVE to B&Q**



20ltr MAIN 5 800w 1000w GRILL QS 🔒

Microwave with grill
H38.8 x W59.5 x D38.5cm

- 8 Auto cooking programmes
- Auto defrost
- LED programmer/timer

BMG20SS Stainless steel 8422248604291 **£103**

cata



20ltr MAIN 5 800w 1000w GRILL QS 🔒

Built in or wall unit microwave with grill
H38.8 x W59.5 x D33.5cm

- 8 Auto cooking programmes
- Auto defrost
- LED timer
- Fits into a 330mm wall unit

BWM20SS Stainless steel 8422248606202 **£123**

COOKE & LEWIS **EXCLUSIVE to B&Q**



20ltr MAIN 5 800w 1000w GRILL QS 🔒

Built in microwave
H38.8 x W59.5 x D38.5cm

- 8 Auto cooking programmes
- Auto defrost
- LED programmer/timer

CLB1SS-C Stainless steel 5052931055593 **£123**

cata **EXCLUSIVE to B&Q**

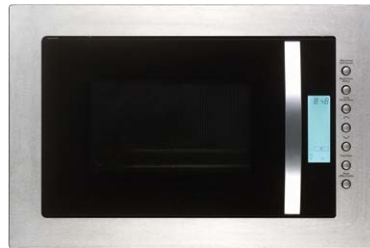

25ltr MAIN 5 800w 1000w GRILL QS 🔒

Microwave with grill
H38.8 x W59.5 x D38.5cm

- 8 Auto cooking programmes
- Auto defrost
- LED programmer/timer

BMG25SS Stainless steel 8422248601382 **£153**

cata **EXCLUSIVE to B&Q**



25ltr MAIN 5 800w 1000w GRILL QS 🔒

Microwave with grill
H38.8 x W59.5 x D38.5cm

- 10 Auto cooking programmes
- Auto defrost
- LED programmer/timer

BMG25BK Black 8422248601375 **£162**

cata **EXCLUSIVE to B&Q**

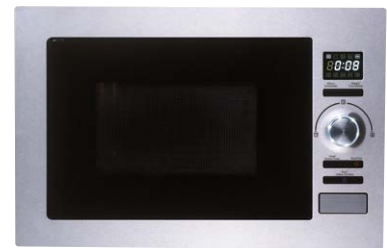

25ltr MAIN 5 900w 1000w GRILL QS 🔒 ⊕

Combination microwave oven and grill
H38.8 x W59.5 x D47cm

- 10 Auto cooking programmes including 2500W convection cooking
- Auto defrost
- LED programmer/timer

BMC25SS Stainless steel 8422248601399 **£198**

All guarantees are manufacturer guarantees. This does not affect your legal rights.

BEKO NEW & EXCLUSIVE



Built in microwave with grill
H38 x W59.5 x D38.5cm



- Automatic cooking combination programmes
- Fully programmer timer for flexibility
- Quick start for busy people
- Auto defrost
- Fingerprint free stainless steel
- Auto menu
- Large display for displaying cooking times

MBW2511X Stainless steel 5023790023726 **£203**

catac EXCLUSIVE to B&Q



Built in microwave with grill
H38.8 x W59.5 x D39.9cm



- 8 Auto cooking programmes
- Auto defrost
- LED programmer/timer

BM25GWH White glass 8422248604307 **£232**
BM25GBK Black glass 8422248604314 **£232**

i INDESIT



Built in microwave
H38.8 x W59.4 x D47cm



- Fan and grill which allows to cook great variety of dishes as in conventional oven
- Digital interface

MWI222IXUK Stainless steel 8007842790726
Was £232 Now £219

COOKE & LEWIS NEW & EXCLUSIVE



Microwave and grill oven
H38.8 x W59.5 x D38.5cm



- 8 Auto cooking programmes
- Auto defrost
- LED programmer/timer

CLM-121 Black stainless/steel 5052931263653 **£247**

COOKE & LEWIS NEW & EXCLUSIVE



Microwave and grill oven
H45.5 x W54.2 x D46.5



- LED digital display
- 5 auto programmes
- Defrost by time and weight
- Stainless steel cavity
- Designed to match Cooke & Lewis ovens

CLMGO-1B Black mirror finish 5052931258703 **£395**

BOSCH



Built in microwave
H28 x W51.3 x D40.5cm



- User-friendly electronics with push-buttons and pop-out control
- 4 Defrost programs and 3 cooking programs
- Large digital display for displaying cooking times and time of day

HMT84M651B Brushed steel 4242002495033 **£384**

KEY
FEATURES
TO LOOK
FOR IN

ceramic hobs



A great choice for high performance and low maintenance.

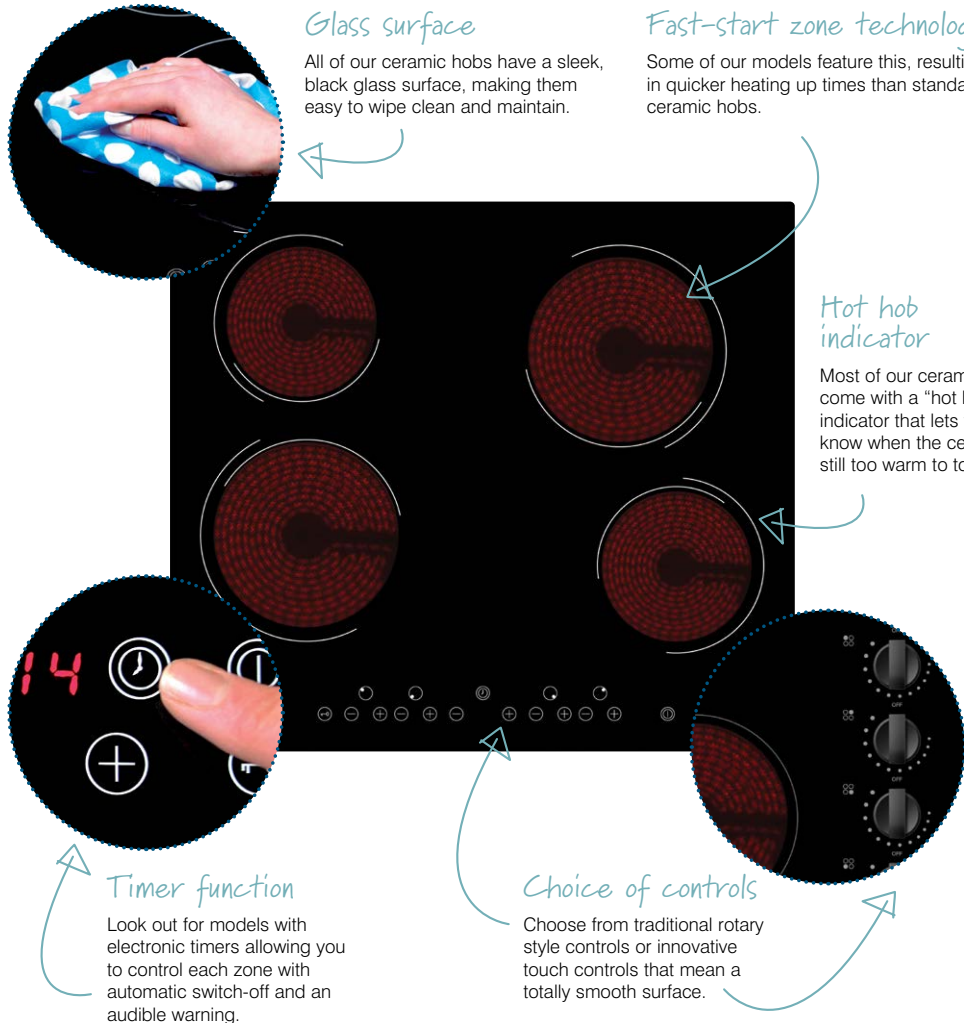

Glass surface

All of our ceramic hobs have a sleek, black glass surface, making them easy to wipe clean and maintain.

Fast-start zone technology

Some of our models feature this, resulting in quicker heating up times than standard ceramic hobs.

Hot hob indicator

Most of our ceramic hobs come with a "hot hob" indicator that lets you know when the ceramic is still too warm to touch.

Timer function

Look out for models with electronic timers allowing you to control each zone with automatic switch-off and an audible warning.

Choice of controls

Choose from traditional rotary style controls or innovative touch controls that mean a totally smooth surface.

symbols guide...

Which type of hob?

Ceramic
High performance and low maintenance. Rapid heat and halogen zones give speed and controllability.

Induction
The quickest and most energy efficient choice. It heats the pan and leaves the hob cool to the touch.

Solid plate
With raised, hard-wearing cast iron hot plates, some models have 'red dot' rapid heat zones for faster cooking.

Gas
The most responsive choice. Gas gives better temperature control than most electric hobs.

Electric zones

Our electric hobs all include 4 electric zones.

Gas burners

Choose a model with 4 or 5 gas burners. Larger 5 burner models give extra cooking space and have a powerful wok burner.

Dual zone

This is a clever feature that means that larger griddles or pans can be used and because it is a user selectable zone, it means it can also be used as a single zone saving energy.

Power levels

The more power levels offered, the more flexibility you have to control the temperature.

Auto ignition

With no separate ignition control the result is a sleeker overall appearance.

Child safety lock

This clever safety feature allows you to lock the controls so that tiny hands can't turn the hob on whilst your back is turned.

25 AMP Electrical connection

This symbol indicates the power supply in amps. This is a guideline only; speak to a qualified electrician.

Manufacturers' guarantees

2yr PARTS 2yr LABOUR

Every appliance is covered by a manufacturer's guarantee for parts and labour. This varies according to the brand and the model. Your legal rights are not affected. Please see individual manufacturers' websites for guarantee details.

cata **EXCLUSIVE to B&Q**

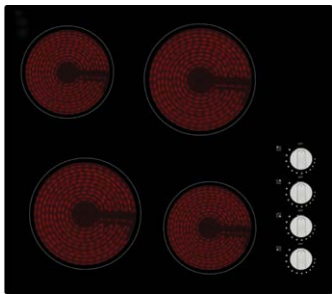

32 AMP

Ceramic hob
H5.5 x W59 x D52cm

- Rotary controls
- Residual heat indicator
- Independent fast-start power zones

2yr PARTS 2yr LABOUR

EC60 Black glass 8422248600309 £172

COOKE & LEWIS **EXCLUSIVE to B&Q**

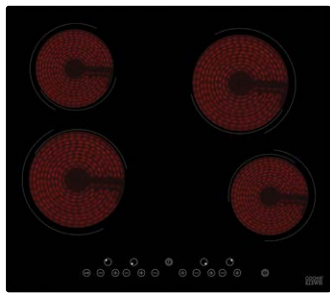

32 AMP

Ceramic hob
H5.5 x W59 x D52cm

- Touch control operation
 - Independent fast-start power zones
 - Timer and heat indicator
- Certain sauce pans are not compatible, please check

2yr PARTS 2yr LABOUR

CLEC1BK-C Black glass 5052931055647 £223

Indesit **EXCLUSIVE to B&Q**



32 AMP

Ceramic hob
H4.6 x W 59 x D52cm

- Touch controls
- Double ring
- Residual heating indicator (for each plate)

5yr PARTS 1yr LABOUR

VRA641DBS Black glass 8007842800012 £253

COOKE & LEWIS **NEW & EXCLUSIVE**

Dual expanded zone

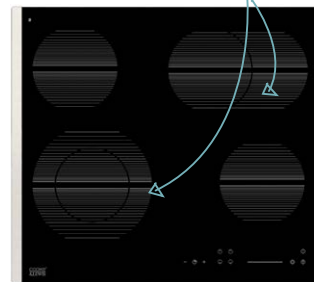

32 AMP

Ceramic dual zone hob
H5.2 x W59 x D52cm

- Slider touch controls
- Dual zone options
- Residual heat indicators
- Timer function

5yr PARTS 2yr LABOUR

CLCDZ-60 Black glass 5052931258598 £264

COOKE & LEWIS **NEW & EXCLUSIVE**

Dual expanded zone

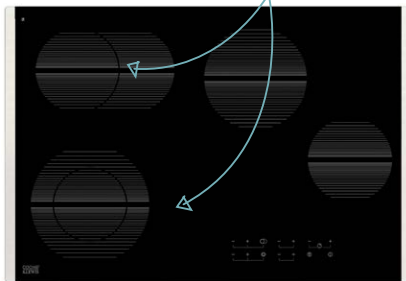

40 AMP

77cm Ceramic dual zone hob
H5.5 x W77 x D52cm

- Touch controls
- Dual zone options
- Residual heat indicators
- Timer function

5yr PARTS 2yr LABOUR

CLCDZ-77 Black glass 5052931258604 £294

BEKO **EXCLUSIVE to B&Q**

Dual expanded zone



32 AMP

Slider touch control Ceramic hob
H5.5 x W77 x D52cm

- Touch and slide front control display
- Booster function for quick heating
- Timer
- Memory function for flexibility
- Advanced safety feature, anti-over flow system auto shut off, child lock

2yr PARTS 2yr LABOUR

QHC64402T Black glass 5023790032520 £305

Hotpoint



28 AMP

Ceramic hob
H4.6 x W59 x D52cm

- Touch controls
- Dual zone

5yr PARTS 1yr LABOUR

CRA641DC Black glass 5016108791035 £352

smeg

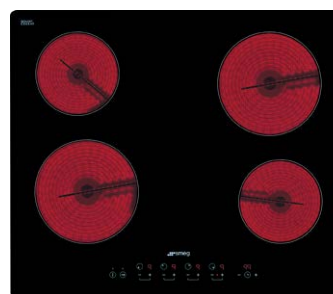

30 AMP

Ceramic hob
H4 x W60 x D51.5cm

- Touch control
- 4 High-light radiant cooking zones

2yr PARTS 2yr LABOUR

SE2640TD2 Black glass 8017709138554 £382

cata **EXCLUSIVE to B&Q**

BOSCH

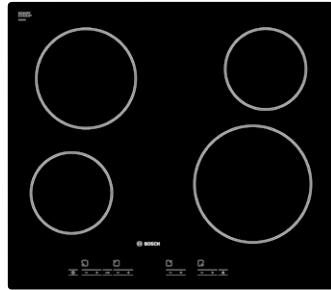

Ceramic hob
H5.3 x W100 x D36cm

2yr PARTS **2yr** LABOUR

- Touch control operation
- Independent power zones
- Timer and heat indicator

Ceramic hob
H5.1 x W59.2 x D52.2cm

2yr PARTS **2yr** LABOUR

- Direct select
- Electronic display

ECL90TF Black glass 8422248028301 **£395**

PKE611D17E Black glass 4242002723914 **£400**

cata **EXCLUSIVE to B&Q**



Ceramic hob
H6.2 x W90 x D51cm

2yr PARTS **2yr** LABOUR

- Touch control operation
- Independent power zones
- Timer and heat indicator

MATX1 Black glass 8422248050296 **£475**



Ceramic Hobs

CHOOSE
FROM OUR
RANGE OF

electric hobs



cata **EXCLUSIVE to B&Q**



32 AMP  

Solid plate hob
H3.9 x W58 x D50cm

2yr PARTS 2yr LABOUR

- Rotary controls
- Heat indicator light
- Auto resetting thermostat prevents overheating

ES60SS2 Stainless steel 8422248600002 **£97**

COOKE & LEWIS **EXCLUSIVE to B&Q**



32 AMP  

Solid plate hob ▲
H3.8 x W58 x D50cm

2yr PARTS 2yr LABOUR

- Rotary controls
- Heat indicator light
- Auto resetting thermostat prevents overheating

CLEP2SS-C Stainless steel 5052931055692 **£103**

INDESIT



32 AMP  

Solid plate hob
H3.3 x W58 x D51cm

2yr PARTS 2yr LABOUR

- Powerful plates
- Inox finish
- On/off indicator

PIM604IX Stainless steel 8007842741711 **£132**

Pick up a copy of our...
'you can do it' book

The complete step-by-step book of Home Improvement

For more
ideas and know-how
visit diy.com/advice

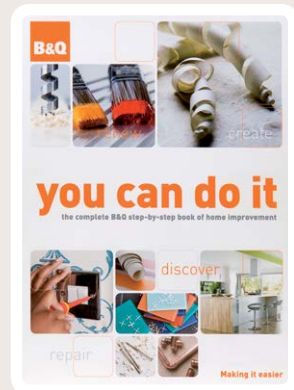

CHOOSE
FROM OUR
RANGE OF

induction hobs



Instant, precise and even heat. Heats the pan and not the hob.

Safest way to cook

Electro-magnet generators underneath the surface of the hob generate a current that's only transferred to the pan. All other areas of the hob stay cool to the touch.



Efficient sensors

Induction hobs automatically sense the size of the pan placed on the ring, however large or small, and only heat the pan making them very energy efficient.

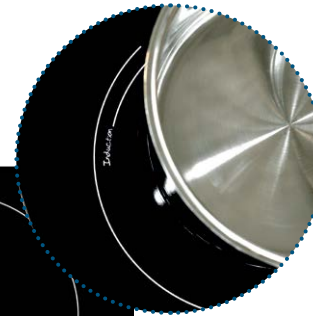

Timer function

Look out for models with electronic timers allowing you to control each zone with automatic switch-off and an audible warning.

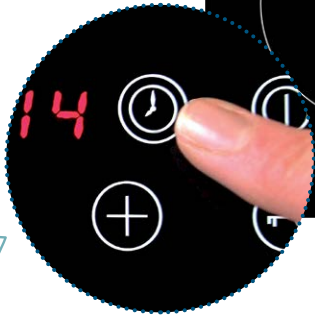

Touch controls

All of our induction hobs offer touch controls resulting in a completely smooth surface.



Easy clean

Our induction hobs have a sleek ceramic surface making them easy to wipe clean and maintain



COOKE & LEWIS **EXCLUSIVE** to B&Q

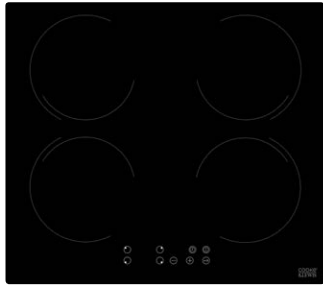

Induction hob ▲
H5.4 x W59 x D52cm

- Touch control operation
- Timer and heat indicator

2yr PARTS 2yr LABOUR

CLIND1BK-C Black glass 5052931055784 **£324**

COOKE & LEWIS **NEW** & **EXCLUSIVE**

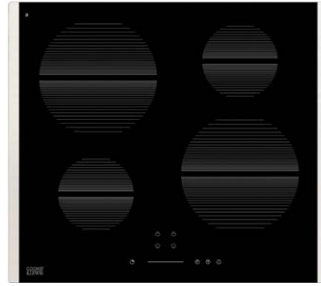

Induction hob
H5.6 x W59 x D52cm

- Slider touch controls
- Booster zones - faster cooking
- Pan detecting system ■ Timer function

5yr PARTS 2yr LABOUR

CLIH-60 Black glass 5052931258659 **£362**

Indesit

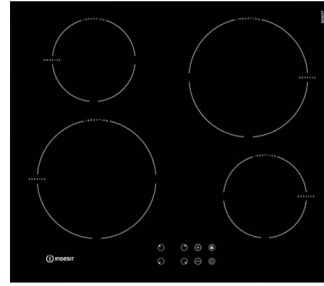

Induction hob
H5.3 x W59 x D51cm

- Easy to use touch controls
- 4 Boost zones

5yr PARTS 1yr LABOUR

VIB644CE Black glass 8007842824728
Was £382 Now £299

Hotpoint **EXCLUSIVE** to B&Q



Induction hob ▲
H5.3 x W59 x D52cm

- Touch controls
- Booster zone

5yr PARTS 1yr LABOUR

CIA641CS Black glass 5016108800171 **£435**

BOSCH

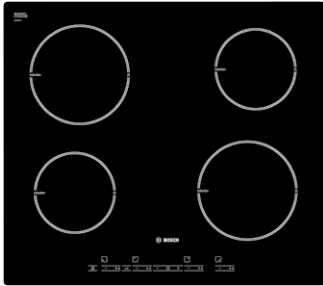

Induction hob
H5.7 x W59.2 x D52.2cm

- Touch control
- Timer with switch-off function for all zones

2yr PARTS 2yr LABOUR

PIE611B18E Black glass 4242002737867 **£437**

COOKE & LEWIS **NEW** & **EXCLUSIVE** *Freezone technology*

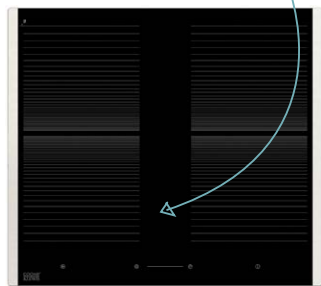

Induction free zone hob
H5.6 x W59 x D52cm

- Freezone - variable pan placement
- Slider touch controls
- Booster zones - faster cooking
- Timer function

5yr PARTS 2yr LABOUR

CLIFZ-60 Black glass 5052931258666 **£495**

COOKE & LEWIS **NEW** & **EXCLUSIVE** *Freezone technology*

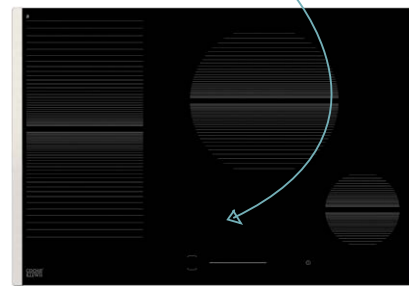

77cm Induction free zone hob
H5.5 x W77 x D52cm

- Freezone - variable pan placement
- Slider touch controls
- Booster zones - faster cooking
- Timer summer function

5yr PARTS 2yr LABOUR

CLIFZ-77 Black glass 5052931258673 **£695**

KEY
FEATURES
TO LOOK
FOR IN

gas hobs



A great choice for adventurous chefs – gas burners give you responsive, immediately controllable heat.

Flame failure technology

A clever safety feature that stops the flow of gas when the flame goes out to prevent a gas leak



Choose your finish

Stainless steel, brushed steel, black or white glass – choose from a range of colours and finishes.

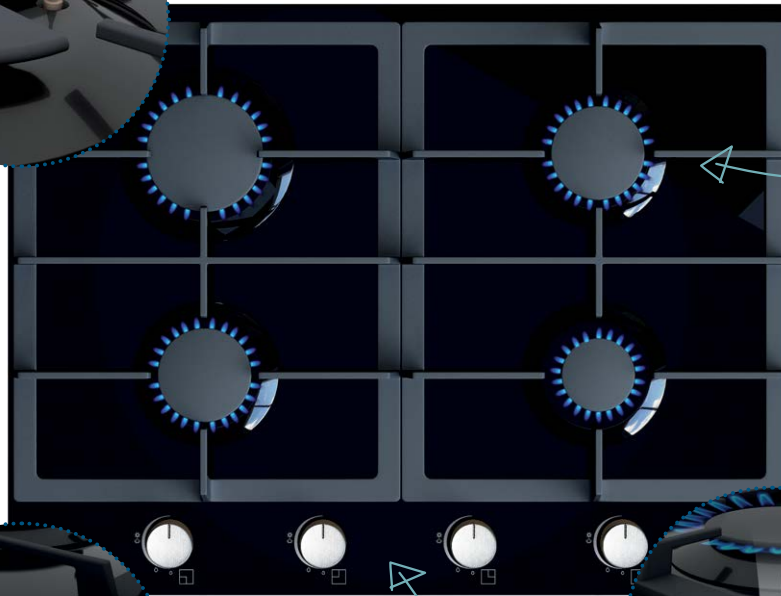

Pan supports

Either cast iron or enamel, they provide a solid base for your pans.



Glass surface

Some of our gas hobs have a smooth glass surface making them easy to wipe clean and maintain.

Automatic ignition

No need for a separate ignition control resulting in a sleeker overall appearance.



COOKE & LEWIS EXCLUSIVE to B&Q



4 Burner gas hob
H4.2 x W58 x D50cm



- Rapid burner
- Matching controls to oven
- LPG conversion kit
- Flame failure device

CLGH3SS-C Stainless steel 5052931055739 **£102**

catac EXCLUSIVE to B&Q



4 Burner gas hob
H4.2 x W58 x D50cm



- Wok and rapid burner
- Cast iron pan supports
- LPG conversion kit
- Flame failure device

GHD60SS Stainless steel 8422248603164 **£153**

Indesit EXCLUSIVE to B&Q



4 Burner gas hob ▲
H3.3 x W58 x D51cm



- Triple ring burner
- Inox finish

PIM640ASTIX Stainless steel 8007842741803
Was £173 Now £149

COOKE & LEWIS NEW & EXCLUSIVE



4 Burner gas hob
H3.9 x W56 x D51cm



- Wok burner
- Cast iron pan stands
- LPG conversion kit
- Flame failure device

CLGSS-60 Stainless steel 5052931258611 **£203**

smeg



4 Burner gas hob
H3 x W60 x D50cm



- 3.10kW rapid burner
- Auto ignition with safety valves
- Heavy duty cast iron pan stands

SE60SGH3 Stainless steel 8017709112059 **£235**

BEKO EXCLUSIVE to B&Q



4 Burner gas hob
H5.5 x W58 x D51cm



- 3.3kw wok burner with wok adaptor for faster cooking
- Cast iron pan support
- One piece easy to clean hob surface
- Flame failure device ■ LPG conversion kit available

QHMW6422X Stainless steel 5023790032285 **£242**

Hotpoint EXCLUSIVE to B&Q



4 Burner gas hob ▲
H4.4 x W65 x D51cm



- Cast iron pan supports
- Automatic ignition
- Complete with LPG convertible kit

GB641X Stainless steel 5016108796474 **£254**

BOSCH



4 Burner gas hob
H5.2 x W58.2 x D52cm



- 1 Rapid, 2 standard, 1 economy burner

PCP615B90B Brushed steel 4242002516455 **£252**
PCP616B90E Black 4242002488097 **£252**

5 burner gas hobs

cataC **EXCLUSIVE to B&Q**



5 Burner gas hob
H4.2 x W68 x D50cm

2yr PARTS **2yr LABOUR**

- Wok and rapid burner
- Cast iron pan supports
- LPG conversion kit
- Flame failure devise

GHD70SS Stainless steel 8422248603171 **£172**

COOKE & LEWIS **EXCLUSIVE to B&Q**



5 Burner gas hob ▲
H4.2 x W68 x D50cm

2yr PARTS **2yr LABOUR**

- Wok and rapid burner
- Cast iron pan supports
- LPG conversion kit
- Flame failure devise

CLGH1SS-C Stainless steel 5052931055753 **£182**

COOKE & LEWIS **NEW & EXCLUSIVE**



5 Burner gas hob
H3.9 x W86 x D51cm

5yr PARTS **2yr LABOUR**

- Wok burner
- Cast iron pan supports
- LPG conversion kits
- Flame failure device

CLGSS-90 Stainless steel 5052931258635 **£247**

Hotpoint



5 Burner gas hob
H3.3 x W75 x D51cm

5yr PARTS **1yr LABOUR**

- Cast iron pan supports
- Triple ring wok burner
- Automatic ignition

GC751TX Stainless steel 5016108789940 **£303**

BOSCH



5 Burner gas hob
H5.2 x W76.2 x D52cm

2yr PARTS **2yr LABOUR**

- 1 Dual wok burner, 1 rapid, 2 standard, 1 economy burner

PCS815B90E Brushed steel 4242002488608 **£397**

Gas on glass

COOKE & LEWIS **EXCLUSIVE to B&Q**



4 Burner gas on glass hob ▲
H3.8 x W58.4 x D51cm

2yr PARTS **2yr LABOUR**

- Rapid burner
- Cast iron pan supports
- LPG conversion kit
- Flame failure devise

CLGH2BK-C Black glass 5052931055746 **£182**

cataC **EXCLUSIVE to B&Q**



4 Burner gas on glass hob
H4.2 x W58 x D51cm

2yr PARTS **2yr LABOUR**

- Wok and rapid burner
- Cast iron pan supports
- LPG conversion kit
- Flame failure device

GHDG60 Black glass 8422248603157 **£198**

COOKE & LEWIS **EXCLUSIVE to B&Q**



4 Burner gas on glass hob
H3.9 x W56 x D51cm

5yr PARTS **2yr LABOUR**

- Wok burner
- Cast iron pan support
- LPG conversion
- Flame failure device

CLGOG-60 Black glass 5052931258628 **£203**

how to shop • in-store • online www.diy.com • phone 0870 0101 006

▲ Our Banbury, Bedford, Burgess Hill, Bognor Regis, Consett, Eastleigh, Fareham, Hedge End, Nursing, Poole, Portsmouth, Port Glasgow and Sydenham stores stock a wide range of products – all available to take away. The Symbol is used throughout this Buying Guide to indicate the products that these stores stock. However these are subject to availability and ranges may vary by store.

Gas on glass

INDESIT EXCLUSIVE to **B&Q**



6 AMP AUTO

4 Burner gas on glass hob ▲
H3.3 x W59 x D51cm

5yr PARTS 1yr LABOUR

- 1 Hand ignition
- Nero glass finish - matching oven available

IPG640SBK Black glass 8007842789454 **£253**

BEKO EXCLUSIVE to **B&Q**



13 AMP AUTO

4 Burner gas on glass hob
H5.5 x W58 x D51cm

2yr PARTS 2yr LABOUR

- 3.3 kw burner with wok adaptor for faster cooking
- Individual cast iron pan support
- One piece easy clean glass hob surface
- Bevelled edge stainless steel frame

QHGW6422B Black 5023790032292 **£283**

BOSCH

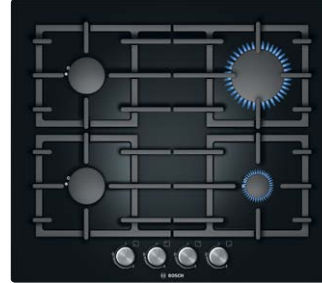

3 AMP AUTO

4 Burner gas on glass hob
H5.8 x W59 x D52cm

2yr PARTS 2yr LABOUR

- 1 Rapid, 2 standard, 1 economy burner

PPP616B91E Black glass 4242002617473 **£348**

5 burner gas on glass

COOKE & LEWIS NEW & EXCLUSIVE

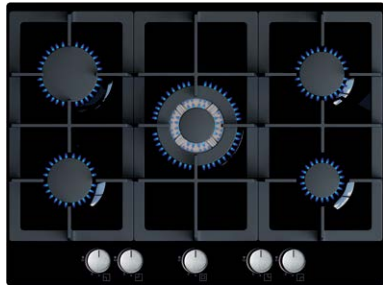

3 AMP AUTO

5 Burner gas on glass hob
H3.8 x W68.4 x D51cm

2yr PARTS 2yr LABOUR

- Wok and rapid burner
- Cast iron pan supports
- Flame failure device
- LPG conversion kit

CLGH70BK Black glass 5052931268399 **£203**

COOKE & LEWIS NEW & EXCLUSIVE

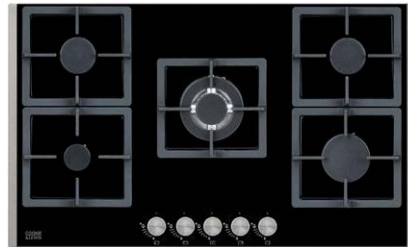

3 AMP AUTO

5 Burner gas on glass hob
H3.9 x W86 x D51cm

5yr PARTS 2yr LABOUR

- Wok burner
- Cast iron pan supports
- LPG conversion kit
- Flame failure device

CLGOG-90 Black 5052931258642 **£253**

Pick up a copy of our...

'you can do it' book

The complete step-by-step book of Home Improvement

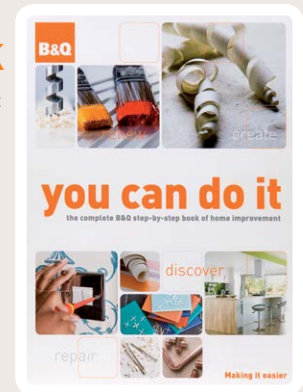

For more
ideas and know-how
visit diy.com/advice

B&Q You can do it

hoods

Cooker hoods are an important part of cooking, extracting grease and odours out of the air so your kitchen is a fresher, more hygienic and enjoyable environment.

Glass surface

Some of our hoods have a glass surface making them easy to wipe clean and maintain.



Adjustable chimney sections

Allows easy fitting in almost any environment.

Control panels

Choose between push-button models, sliders or super-smooth touch controls for a sleek looking hood.

Aluminium filter

Filters are dishwasher safe – regular washing will provide maximum performance.

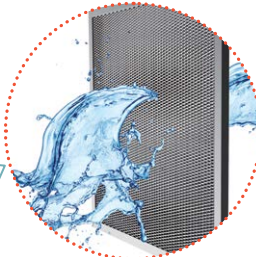

Light

All of our hoods include a light. Look out for low energy bulbs, LED or halogen.

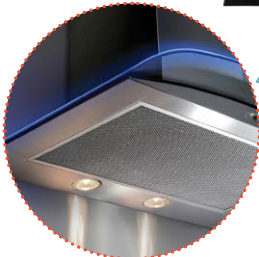

Extraction or re-circulation?

Extraction is more efficient, drawing vapours outside – for this your hood needs to be close enough to an outside wall for ducting to be installed. Recirculation is a great alternative and draws odours through a filter to be purified and released back into the kitchen.

symbols guide...

Which type of hood?

Your kitchen and cooker type will help to determine the type of hood that you need; your style will help to determine the design. Choose from built in or integrated hoods; chimney hoods, island hoods or freestanding. Our hoods range includes smooth, curved or flat glass and sleek stainless steel visor or designer box hoods.

Washable filter

Filters are dishwasher safe – regular washing will provide maximum performance.

Electrical connection

This symbol indicates the power supply (amps). This is a guideline only; speak to a qualified electrician.

Extraction rate

The rate of extraction is measured in cubic metres per hour (m³/hr); the higher the figure, the better the rate of extraction – this varies across different types of hood and between models.

Vent pack

To extract air outside you will need a vent pack. This symbol appears below each product and shows which number vent pack you need to buy. See page 262 for vent packs.

Speed settings

This symbol indicates the number of speed settings available to extract or re-circulate air.

Manufacturers' guarantees

2yr PARTS

Every appliance is covered by a manufacturer's guarantee for parts and labour. This varies according to the brand and the model. Your legal rights are not affected. Please see individual manufacturers' websites for guarantee details.

2yr LABOUR

Noise level

Noise levels range between 46dB and 76dB.

Timer

Once the timer feature is activated the extractor will operate for 5 minutes at current speed and 5 minutes at each of the lower speeds until coming to a complete stop.

vent
packs...

In order to extract your hood, please see below for a selection of vent and duct kits.

Vent Kits

1	120/125mm vent kitt	8015250038873	£35
2	150mm vent kit	8015250024951	£43

Extension Kits

A	100mm x 1.5m duct kit	8015250024968	£13
B	125mm x 1.5m duct kit	8015250024982	£13
C	150mm x 1.5m duct kit	8015250024999	£13

Smeg Vent Kits

D	simple 125mm vent kit SP215	5014662015000	£54
E	comp 125mm vent kit SP217	5014662015789	£84
F	simple 150mm vent kit SP150	5014662009870	£54
G	flat comp 150mm vent kit SP150 FLAT	5014662015796	£54

COOKE & LEWIS
EXCLUSIVE to B&Q



3 AMP 3 SPEED 380 m³/hr 55dB(A) 2 VENT KIT

Visor hood ▲
H11.2 x W60 x D47cm

- Push button controls
- Acrylic grease filter
- 1 Low energy light

CLVH60SS-C Stainless steel 5052931055852 £62

CLVH60W-C White 5052931055869 £62

FILTER 8422248029766 £7.98

Designair
EXCLUSIVE to B&Q



3 AMP 2 SPEED 400 m³/hr 61dB(A) 2 VENT KIT WASH

Telescopic hood
H14 x W60 x D47.3cm

- Slider controls
- 1 Low energy light

TH60SS Stainless steel 8422248024044 £92

Intergrated hoods

COOKE & LEWIS
EXCLUSIVE to B&Q



3 AMP 3 SPEED 340 m³/hr 55dB(A) 2 VENT KIT

Integrated hood ▲
H40 x W60 x D27cm

- Slider controls
- Acrylic grease filter
- 1 Low energy light

CLIH60-C Silver 5052931055777 £92

FILTER 8422248029766 £7.98

Chimney hoods

COOKE & LEWIS
EXCLUSIVE to B&Q



3 AMP 3 SPEED 480 m³/hr 55dB(A) 2 VENT KIT WASH

Chimney hood
H66.5-90.8 x W60/90 x D47.3cm

- Push button controls
- 1 Low energy light

CLCH60SS-C ▲ Stainless steel W60cm 5052931055609 £104

CLCH70SS Stainless steel W70cm 5052931268337 £109

CLCH90SS-C Stainless steel W90cm 5052931055616 £134

FILTER 8422248036979 £15.25

Designair
EXCLUSIVE to B&Q



3 AMP 3 SPEED 400 m³/hr 55dB(A) 2 VENT KIT WASH

Chimney hood
H66.5-90.8 x W60/70/90 x D47.3cm

- Push button controls
- 1 Low energy light

CHK60BK Black W60cm 8422248600552 £135

CHK70BK Black W70cm 8422248600569 £164

CHK90BK Black W90cm 8422248600576 £193

FILTER 8422248036979 £15.25

Indesit



3 AMP 3 SPEED 451 m³/hr 70dB(A) 2 VENT KIT

Chimney hood
H68.5 x W59.8 x D50cm

- Recirculation filter included making installation easy - no duct required
- Button controls
- 2x 25w lights

IHP65FCMIX Stainless steel 8007842836424

Was £179 Now £129

smeg



13 AMP 3 SPEED 530 m³/hr 70dB(A) F VENT KIT

Chimney hood
H100 x W60 x D50cm

- 215w High performance motor
- 2 Aluminium anti-grease filters
- 2 Halogen lights

KD61X Stainless steel 8017709154004 £205

FILTER 8017709103705 £32

Curved glass

Designair EXCLUSIVE to B&Q



3 AMP 3 SPEED 480 m³/hr 55dB(A) 2 VENT FLEX WASH

Curved glass chimney hood
H62.6-91.6 x W60 x D60cm

2yr PARTS 2yr LABOUR

- Push button controls
- 1 Low energy light

GHP61BK	Black	8422248604116	£163
FILTER		8422248036979	£15.25

COOKE & LEWIS EXCLUSIVE to B&Q



3 AMP 3 SPEED 480 m³/hr 55dB(A) 2 VENT FLEX WASH

Curved glass chimney hood
H62.6-91.6 x W60/90 x D47cm

2yr PARTS 2yr LABOUR

- Push button controls
- 1 Low energy light

CLGCH60-C	▲ Stainless steel	W60cm	5052931055715	£153
CLGCH70	Stainless steel	W70cm	5052931268375	£163
CLGCH90-C	Stainless steel	W90cm	5052931055722	£172
FILTER			8422248036979	£15.25

Designair EXCLUSIVE to B&Q



3 AMP 3 SPEED 400 m³/hr 55dB(A) 2 VENT FLEX WASH

LED curved glass chimney hood
H62.6-91.6 x W60/70/90 x D47.3cm

2yr PARTS 2yr LABOUR

- Push button controls
- 2 Halogen lights

GLED60SS	Stainless steel	W60cm	8422248600606	£203
GLED70SS	Stainless steel	W70cm	8422248600927	£225
GLED90SS	Stainless steel	W90cm	8422248600934	£235
FILTER			8422248036979	£15.25

INDESIT



3 AMP 3 SPEED 434 m³/hr 69dB(A) 2 VENT

Curved glass chimney hood
H69 x W59.8 x D44.9cm

5yr PARTS 1yr LABOUR

- Recirculation filter included making installation easy - no duct required
- Halogen lights

IHC6 5FAMIX	Stainless steel		8007842843255	
				Was £249 Now £200

Hotpoint



13 AMP 3 SPEED 514 m³/hr 61dB(A) 2 VENT FLEX WASH

Curved glass chimney hood
H69 x W59.8 x D44.9cm

5yr PARTS 1yr LABOUR

- Soft button control
- Halogen lights

HDA6 5AB	Stainless steel	5016108821824	£299
----------	-----------------	---------------	------

Flat glass hoods

Designair EXCLUSIVE to B&Q



3 AMP 3 SPEED 480 m³/hr 62dB(A) 2 VENT FLEX WASH

Flat glass chimney hood
H68-110 x W60/70/90 x D48cm

2yr PARTS 2yr LABOUR

- Push button controls
- 2 Halogen lights

ORION60	Stainless steel	W60cm	8422248038324	£162
ORION70	Stainless steel	W70cm	8422248038331	£173
ORION90	Stainless steel	W90cm	8422248038348	£182

Designer box hoods

Designair EXCLUSIVE to B&Q



3 AMP 3 SPEED 480 m³/hr 55dB(A) 2 VENT FLEX WASH

Box chimney hood
H64-92.7 x W60/90 x D47cm

2yr PARTS 2yr LABOUR

- Electronic touch control operation
- 2 Halogen lights

MRN60WH	Stainless steel	W60cm	8422248604208	£132
MRN90WH	Stainless steel	W90cm	8422248604222	£162
FILTER			8422248036979	£15.25

Designair EXCLUSIVE to B&Q



3 AMP 3 SPEED 480 m³/hr 55dB(A) 2 VENT FLEX WASH

Box chimney hood
H64-92.7 x W60/70/90 x D47cm

2yr PARTS 2yr LABOUR

- 2 Halogen lights

MRN60	Stainless steel	W60cm	8422248603409	£153
MRN70	Stainless steel	W70cm	8422248603416	£162
MRN90	Stainless steel	W90cm	8422248603423	£172
FILTER			8422245036979	£15.25

how to shop • in-store • online www.diy.com • phone 0870 0101 006

Designer box hoods

INDESIT



3 AMP 3 SPEED 490 m³/hr 61dB(A) 3 VENT PACK

Box chimney hood
H70 x W59.8 x D50.6cm

5yr PARTS 1yr LABOUR

- Recirculation filter included making installation easy - no duct required
- T-box shape
- Halogen lights

IHT65FCMIX Stainless steel 8007842843262 **£229**

COOKE & LEWIS EXCLUSIVE to B&Q



3 AMP 3 SPEED 480 m³/hr 55dB(A) 2 VENT PACK WASH

Box chimney hood
H73-113 x W90 x D47cm

2yr PARTS 2yr LABOUR

- Electronic touch controls
- 2 Halogen lights

CLMIRAG60C	Stainless steel	5052931268405	£198
CLMIRAG70C	Stainless steel	5052931268412	£173
CLMIRAG90C	Stainless steel	5052931055791	£183
FILTER		8422245036979	£15.25

COOKE & LEWIS NEW & EXCLUSIVE



3 AMP 3 SPEED 740 m³/hr 69dB(A) 2 VENT PACK WASH

Box half glass hood
H74.5-103 x W60/70/90 x D50cm

5yr PARTS 2yr LABOUR

- Electronic touch control operation
- 2x LED lights

CLBHGH-60	S/steel & black glass	5052931258727	£207
CLBHGH-70	S/steel & black glass	5052931258734	£215
CLBHGH-90	S/steel & black glass	5052931258741	£235

COOKE & LEWIS



3 AMP 3 SPEED 740 m³/hr 69dB(A) 2 VENT PACK

Motorised telescopic box hood
H79.5-106 x W90 x D338-493cm

5yr PARTS 2yr LABOUR

- Motorised telescopic function
- Touch control panel
- 2 x LED light
- Filter cleaning warning
- Timer function

CLTH-90 Stainless steel 5052931258710 **£324**

Designer hoods

Designair EXCLUSIVE to B&Q



3 AMP 3 SPEED 851 m³/hr 61dB(A) 2 VENT PACK WASH

Designer chimney hood
H85.5-115 x W60/70/90 x D50cm

2yr PARTS 2yr LABOUR

- Electronic touch controls
- 2 Halogen lights

VL360SS	Stainless steel	W60cm	8422248600583	£152
VL370SS	Stainless steel	W70cm	8422248600590	£162
VL390SS	Stainless steel	W90cm	8422248028318	£173

Designair EXCLUSIVE to B&Q



3 AMP 3 SPEED 851 m³/hr 55dB(A) 2 VENT PACK WASH

Designer chimney hood
H72.5-111 x W60 x D55cm

2yr PARTS 2yr LABOUR

- Push button controls
- 2 Low energy lights

TCH60SS Stainless steel 8422248024105 **£183**

Designair EXCLUSIVE to B&Q



3 AMP 3 SPEED 851 m³/hr 61dB(A) 2 VENT PACK WASH

Angled glass chimney hood
H80.5-112.5 x W60 x D41.5cm

2yr PARTS 2yr LABOUR

- Electronic touch controls
- 2 Halogen lights

AGS60BK	Black	8422248603393	£173
FILTER		8422248036979	£15.25

COOKE & LEWIS NEW & EXCLUSIVE



3 AMP 3 SPEED 520 m³/hr 62dB(A) 2 VENT PACK WASH

Circular angled glass hood
H91-126 x W60 x D35.5

5yr PARTS 2yr LABOUR

- Electronic touch controls
- 2x LED lights
- Filter cleaning warning
- Timer function

CLCAGH22 Black glass & S/steel 5052931258581 **£197**

Designair EXCLUSIVE to B&Q



3 AMP 3 SPEED 851 m³/hr 61dBA 2 VENT PACK WASH

Angled glass chimney hood
H83.2-124 x W60/70/90 x D46cm

2yr PARTS 2yr LABOUR

- Electronic touch controls
- 2 Halogen lights

AGS60SS	Stainless steel	W60cm	8422248600507	£193
AGS70SS	Stainless steel	W70cm	8422248600514	£197
AGS90SS	Stainless steel	W90cm	8422248600521	£218

COOKE & LEWIS EXCLUSIVE to B&Q



3 AMP 3 SPEED 520 m³/hr 62dBA 2 VENT PACK WASH

Designer angled chimney hood
H91-126 x W60 x D30cm

2yr PARTS 2yr LABOUR

- Electronic touch control operation
- 2 Halogen lights
- Filter cleaning warning
- Timer function

CLTHAL60-C	Black glass	5052931055845	£234
CLTHAL70-C	Black glass	5052931268429	£254
CLTHAL90-C	Black glass	5052931268436	£265

COOKE & LEWIS NEW & EXCLUSIVE



3 AMP 3 SPEED 520 m³/hr 62dBA 2 VENT PACK WASH

Angled glass hood
H91-126 x W60/70/90 x D37.5cm

5yr PARTS 2yr LABOUR

- Electronic touch control operation
- 2x LED lights
- Filter cleaning warning
- Timer function

CLAGH-60	Black glass	5052931258772	£234
CLAGH-70	Black glass	5052931258789	£245
CLAGH-90	Black glass	5052931258796	£263

Designair EXCLUSIVE to B&Q



3 AMP 800 m³/hr 62dBA 2 VENT PACK WASH

Angled glass chimney hood
H74-124 x W90 x D46cm

2yr PARTS 2yr LABOUR

- Electronic slider controls for variable speed
- 2 LED lights
- Filter cleaning warning
- Timer function

DALIBK	Black glass	8422248052559	£394
DALIWH	White glass	8422248052542	£394

Designair EXCLUSIVE to B&Q



3 AMP 3 SPEED 800 m³/hr 62dBA 2 VENT PACK WASH

Curved angled glass chimney hood
H74-124 x W90 x D46cm

2yr PARTS 2yr LABOUR

- Electronic touch controls
- 2 Halogen lights
- Filter cleaning warning
- Timer function

EVOB	Black glass	8422248052511	£495
EVOV	White glass	8422248052504	£497

COOKE & LEWIS NEW & EXCLUSIVE



3 AMP 4 SPEED 760 m³/hr 62dBA 2 VENT PACK WASH

Down draft hood
H74-104 x W90 x D39.2cm

5yr PARTS 2yr LABOUR

- Motorised extension control
- Electronic touch control operation
- LED perimeter lighting
- Extraction only
- Timer function
- Cannot be used with gas hob

CLDH-14	S/steel & black steel	5052931258819	£592
---------	-----------------------	---------------	------

Designair EXCLUSIVE to B&Q



3 AMP 800 m³/hr 62dBA 2 VENT PACK WASH

Curved angled glass chimney hood
H139-176 x W90 x D49cm

2yr PARTS 2yr LABOUR

- Electronic slider controls for variable speed
- 4 LED lights
- Filter cleaning warning
- Timer function

EVO	Black glass	8422248050371	£847
EVO	White glass	8422248050449	£874

Designair EXCLUSIVE to B&Q



3 AMP 4 SPEED 990 m³/hr 63dBA 2 VENT PACK WASH

Corian chimney hood
H128-158 x W90 x D50cm

2yr PARTS 2yr LABOUR

- Electronic controls
- 2 LED lights
- Filter cleaning warning
- Timer function

CORHD90SS	White corian	8422248028288	£987
-----------	--------------	---------------	------

Island hoods

Designair **EXCLUSIVE** to B&Q



Curved glass island hood
H84.5-114.5 x W90 x D60cm

- Push button controls
- 4 Halogen lights

2yr PARTS **2yr LABOUR**

GIHD90SS Stainless steel 8422248024136 **£232**

COOKE & LEWIS **NEW** & **EXCLUSIVE**



Island box hood
H98-138 x W42 x D42cm

- 4 LED lights
- Electronic touch control operation
- Filter cleaning warning

5yr PARTS **2yr LABOUR**

CLIBH-11 S/steel 5052931258680 **£394**

COOKE & LEWIS **NEW** & **EXCLUSIVE**



Island glass hood
H98-109 x W90 x D59.9cm

- 4 LED lights
- Electronic touch control operation
- Filter cleaning warning

5yr PARTS **2yr LABOUR**

CLIBH-12 Black glass & S/steel 5052931258697 **£394**

Designair **EXCLUSIVE** to B&Q



Chandelier hood
H86-170 x W40 x D40cm

- Electronic controls
- Carbon filter supplied
- 3 LED lights

2yr PARTS **2yr LABOUR**

CHANDELIER Stainless steel 8422248052566 **£574**

STYLISH
FINISHING
TOUCHES

splashbacks



A stylish and seamless alternative to traditional tiles. Splashbacks in glass, acrylic or stainless steel can match with your hob and cooker hood to add that perfect finishing touch to your kitchen.

Standard splashbacks for each width of hood

■ Can be used with any standard 60cm hoods	H75 x W60cm	Stainless steel	SB60SS	8422248029346	£64
■ Can be used with any standard 70cm hoods	H75 x W70cm	Stainless steel	SB70SS	8422248034449	£68
■ Can be used with any standard 90cm hoods	H75 x W90cm	Stainless steel	SB90SS	8422248034456	£78

Finished to match hob and cooker hood

■ To match hoods ALPHA6WH and MRN60WH	H70 x W60cm	White	GSB60WH	8422248604239	£68
■ To match hoods ALPHA6BK, MRN60, GHP61BK and CLTHAL60-C	H70 x W60cm	Black	GSB60	8422248603430	£68
■ To match hood AGS60BK	H70 x W60cm	Black glass	ASB60GBK	8422248033657	£78
■ To match hoods MRN90WH and ALPHA9WH	H70 x W90cm	White	GSB90WH	8422248604253	£87
■ To match hoods ALPHA7BK and MRN70	H70 x W70cm	Black	GSB70	8422248603447	£85
■ To match hoods ALPHA9BK, MRN90 and CLMIRAG90-C	H70 x W90cm	Black	GSB90	8422248603454	£107

KEY
FEATURES
TO LOOK
FOR IN

dual fuel range cookers

A passion for cooking deserves an outstanding cooker. Our choices ensure that style and elegance go hand in hand with extreme versatility.

Fuel options

A dual fuel range cooker gives you the benefit of cooking with an electric oven but with the responsiveness of a gas hob.

Self-cleaning ovens!

Some of our ovens are **pyrolytic** and use the ultimate in self-cleaning technology. Protected by an automatic locking, quadruple-glazed door, the oven heats up inside to 500°C to burn off any grease or dirt in no time at all.

Glass door?

Allows you to see what's cooking – no need to open the door and let heat escape whilst cooking.

Size matters!

Our range cookers are available in sizes ranging from the more compact 60cm model to 90, 100 and 110cm models.

LED programmable timer

Ensures every dish is cooked to perfection.

Catalytic stay clean liners

Featured in some ovens, these break down grease or spilled food when used on a high heat setting. The next best thing to pyrolytic.

COOKE & LEWIS EXCLUSIVE



Was £899
Now £796
save £103



90cm range cooker
H90 x W90 x D60cm

2yr PARTS 2yr LABOUR

- Cast iron pan supports
- Digital programmer
- 5 burners

CLDFRC-90 Stainless steel 5397007147797 **£899**

LEISURE NEW



90cm Cookmaster Dual Fuel
H90 x W90 x D60cm

1yr PARTS 1yr LABOUR

- Dedicated grill with pan & handle
- Five burner gas hob with wok burner
- Catalytic liners to keep oven clean
- Removable inner door glass

CK90F232K Black 5023790032742 **£925**
CK90F232B Blue 5023790032773 **£925**

Symbols guide...

Which type of cooking?

Fan oven

Continuous circulation of hot air ensures even heat distribution and faster cooking.

Conventional oven

Heating elements circulate hot air naturally creating varying temperatures – perfect for the Sunday roast!

Multifunctional oven

Fan and conventional cooking in one oven. These ovens offer a range of functions, some offer defrosting, rotisserie style/fan assisted grilling.

Oven capacity

Our range cookers all have two ovens with main oven capacities ranging from 42 to a massive 76 litres.

Electrical connection

This symbol indicates the power supply in amps. This is a guideline only; speak to a qualified electrician.

Grilling

Provides fast cooking and virtually instant heat, perfect for browning meats quickly. Some ovens offer full or half grill options, whilst some include a fan for a more even cooking result.

Grilling Fan grilling

Half grill Fan with half grill

Energy efficiency

These symbols tell you how energy efficient each appliance is with 'A' being the most efficient and 'D' being the least.

Manufacturers' guarantees

Every appliance is covered by a manufacturer's guarantee for parts and labour. This varies according to the brand and the model. Your legal rights are not affected. Please see individual manufacturers' websites for guarantee details.

90cm dual fuel



90cm Cookmaster Dual Fuel
H90 x W90 x D60cm

- Dedicated grill with pan & handle
- 66L secondary tall fan oven for extra capacity
- Fully programmable timer
- Catalytic liners to keep oven clean

CK90F232C Cream 5023790032759 **£925**



90cm Cookmaster Dual Fuel
H90 x W90 x D60cm

- Dedicated grill with pan & handle
- 66L secondary tall fan oven for extra capacity
- Five burner gas hob with wok burner
- Catalytic liners to keep oven clean
- Fully programmable timer

CK90F232R Red 5023790032766 **£925**



90cm Cuisinemaster Dual Fuel
H90 x W90 x D60cm

- 28L capacity third oven
- Catalytic liners to keep oven clean
- Five burner gas hob with wok burner
- Dedicated grill cavity with pan and handle

CS90F530X Stainless steel 5023790032698 **£1013**
CS90F530K Black 5023790032704 **£1013**



90cm Dual fuel range cooker
H90-93 x W89.6 x D60cm

- Cast iron pan supports
- Programmable main oven
- Large capacity tall oven
- LED display

DB4 90DFT Stainless steel 5052263005358 **£1034**



90cm Dual fuel range cooker
H90 x W90 x D60cm

- Large 5 burner gas hob top
- LED display
- Cast iron pan supports

SUK92P9-1 Cream 8017709172299 **£1402**
SUK92MX9 Stainless steel 8017709172305 **£1402**
SUK92MBL9 Black 8017709172312 **£1402**



90cm Pyrolytic dual fuel range cooker
H90 x W89.8 x D59.8cm

- Pyrolytic main oven
- Large 6 burner gas hob with cast iron pan supports
- LED display

SY92PX8 Stainless steel 8017709149604 **£1732**



90cm Traditional dual fuel range cooker
H90 x W90 x D60cm

- Cast iron pan supports
- LED display
- Grill compartment top left 36 litres

TR93P Cream 8017709181703 **£1875**
TR93BL Black 8017709182458 **£1875**

100cm dual fuel



100cm Cookmaster dual fuel range cooker
H90 x W100x D60cm

1 yr PARTS 1 yr LABOUR

- Fully programmable timer with large display
- Storage compartment for pots and pans
- 7 burner hob with wok burner
- Cook clean catalytic liners

CK100F232S	Silver	5023790031608	£1073
CK100F232K	Black	5023790031615	£1073
CK100F232R	Red	5023790031639	£1073
CK100F232B	Blue	5023790031646	£1073



100cm range cooker
H90 x W100x D60cm

2 yr PARTS 2 yr LABOUR

- Cast iron pan supports
- Digital programmer
- 6 burners

CLDFRC-100	Stainless steel	5397007147780	£987
------------	-----------------	---------------	------



100cm Country Classic dual fuel range cooker
H90-93 x W99.6 x D59.5cm

1 yr PARTS 1 yr LABOUR

- Cast iron pan supports
- Minute minder / LED display
- Easy clean enamel

100DFT	Anthracite	5034700494406	£1094
100DFT	Silver effect	5034700494413	£1094



100cm Cuisinmaster Dual Fuel
H90 x W100x D60cm

1 yr PARTS 1 yr LABOUR

- 28l slow cooker 3rd oven
- Fully programmable timer with large display
- 5 burner hob with wok burner + griddle
- Cook clean catalytic liners

CS100F520X	Stainless steel	5023790031578	£1234
CS100F520K	Black	5023790031585	£1234



100cm Richmond dual fuel range cooker
H90-93 x W99.6 x D60cm

5 yr PARTS 1 yr LABOUR

- Cast iron pan supports
- Slow cook oven
- LED display

100DFT	Champagne	5052263002005	£1524
100DFT	Black	5052263001992	£1524

110cm dual fuel



110cm Cookmaster Dual Fuel
H90 x W110x D60cm

1 yr PARTS 1 yr LABOUR

- Fully programmable timer with large display
- Storage compartment for pots and pans
- Cook clean catalytic liners
- 7 burner hob with wok burner

CK110F232S	Silver	5023790031509	£1257
CK110F232K	Black	5023790031516	£1257
CK110F232C	Cream	5023790031523	£1257



110cm Cuisinmaster Dual Fuel
H90 x W110x D60cm

1 yr PARTS 1 yr LABOUR

- Advanced animated timer and main oven control
- 28L slow cooking 3rd oven
- 5 burner hob with wok burner
- Cook clean catalytic liners

CS110F722X	Stainless steel	5023790031486	£1347
CS110F722K	Black	5023790031493	£1347



110cm Traditional dual fuel range cooker
H90 x W110 x D60cm

2 yr PARTS 2 yr LABOUR

- Large 7 burner gas grill with 4.2kW wok burner
- LED display
- 2 large multifunction oven

TR4110P1	Cream	8017709176655	£2013
TR4110BL1	Black	8017709176648	£2013

90cm Gas



90cm Cookmaster Gas Range Cooker
H90 x W90x D60cm



- Conventional main gas oven
- Secondary tall electric fan oven
- Catalytic liners to keep oven clean
- Five burner gas hob with wok burner

CK90G232K Black 5023790032810 **£915**



90cm Cookmaster Gas Range Cooker
H90 x W90x D60cm



- Conventional main gas oven
- Secondary tall electric fan oven
- Catalytic liners to keep oven clean
- Five burner gas hob with wok burner

CK90G232C Cream 5023790032827 **£915**

100cm Gas



100cm gas cookmaster range cooker
H90 x W100x D60cm



- Fully programmable timer with large display
- Cook clean catalytic lines
- 7 burner hob with wok burner

CK100G232K Black 5023790031691 **£1023**
CK100G232C Cream 5023790031707 **£1023**



100cm Country Classic gas range cooker
H90-93 x W99.6 x D59.5cm



- Cast iron pan supports
- Minute minder / LED display
- Easy clean enamel

100GT Silver effect 5034700494437 **£1023**



100cm Richmond gas range cooker
H90-93 x W99.6 x D60cm



- Cast iron pan supports
- 2 Main gas ovens
- Slow cook oven
- LED display

1000GT Champagne 5052263001985 **£1528**
1000GT Black 5052263001978 **£1528**

110cm gas



110cm Richmond gas range cooker
H90-93 x W109.6 x D60cm



- Cast iron pan supports
- 2 Main gas ovens
- Slow cook oven
- LED display

1100GT Black 5052263002012 **£1534**
1100GT Champagne 5052263002029 **£1534**

KEY
FEATURES
TO LOOK
FOR IN

electric range cookers

Stylish and functional with fast warm-up times, our electric range cookers provide you with a great deal of cooking flexibility.



Induction hob?

Look out for induction hob models – these hobs heat the pan and not the hob offering a smarter, faster, safer and energy efficient way to cook.

LED programmable timer

Ensures every dish is cooked to perfection.



Size matters!

Our range cookers are available in sizes ranging from the more compact 60cm model to 90, 100 and 110cm models.

Slow cook oven

Take a look at models that feature a dedicated slow cook oven – perfect for cooking meals on a low heat; ideal for stews and casseroles.

Glass door?

Allows you to see what's cooking – no need to open the door and let heat escape whilst cooking.

Catalytic stay clean liners

When used at a high heat, ovens with a catalytic liner break down the grease in any food spill onto them – making cleaning less of a chore.

Telescopic sliders?

Some of our electric range cookers feature intelligently designed telescopic shelves that allow easy access to food inside the oven.

60cm electric cookers



60cm Gourmet electric mini range cooker
H90 x W60 x D60cm



- Two ovens for flexible cooking and maximum capacity
- Main fan oven for faster cooking and more even heat distribution

GRB6CVR	Regency red	5023790029407	£563
GRB6CVK	Black	5023790028738	£563
GRB6CVC	Cream	5023790028721	£563

90cm electric cookers



90cm Cookmaster Electric Range Cooker
H90 x W90 x D60cm



- 66L secondary tall fan oven for extra capacity
- Catalytic liners to keep oven clean
- Five zone ceramic hob with central dual zone
- Fully programmable timer

CK90C230S	Silver	5023790032780	£905
CK90C230K	Black	5023790032797	£905
CK90C230C	Cream	5023790032803	£905



90cm Cuisinemaster Electric Range Cooker
H90 x W90 x D60cm



- 28L capacity third oven
- Five zone ceramic hob with central dual zone
- Catalytic liners to keep oven clean
- Dedicated grill cavity with pan and handle

CS90C530K	Black	5023790032728	£1035
CS90C530X	Stainless steel	5023790032711	£1035



90cm Electric range cooker
H90-93 x W89.6 x D60cm



- Ceramic hob with 5 elements including 1 dual zone
- Large capacity tall oven
- LED display

DB4 90E	Stainless steel	5052263005341	£1045
---------	-----------------	---------------	-------



90cm Electric range cooker
H90 x W90 x D60cm



- Easy removable inner door glasses
- Total 5 zones including one dual zone
- LED display

SUK92CMX9	Stainless steel	8017709172329	£1732
SUK92CBL9	Black	8017709172336	£1732

100cm electric cookers



100cm electric cookmaster range cooker
H90 x W100 x D60cm



- Fully programmable timer with large display
- 5 zone ceramic hob with separate warming zone
- Cook clean catalytic lines in main & secondary oven

CK100C210K	Black	5023790031660	£1075
CK100C210S	Silver	5023790032506	£1075
CK100C210C	Cream	5023790031677	£1075

CHOOSE FROM OUR RANGE OF

range cooker hoods



symbols guide...

Which type of hood?

Once you've chosen the style, size and colour of range cooker you want you can choose a range cooker hood to match. There's three sizes available, 90, 100 and 110cm widths in a choice of stainless steel and black finishes.

380 m³/hr Extraction rate

The rate of extraction is measured in cubic metres per hour (m³/hr); the higher the figure, the better the rate of extraction – this varies across different types of hood and between models.

3 SPEED Speed settings

This symbol indicates the number of speed settings available to extract or re-circulate air.

53dBA Noise level

Noise levels range between 55dB and 75dB.

Timer

Once the timer feature is activated the extractor will operate for 5 minutes at current speed and 5 minutes at each of the lower speeds until coming to a complete stop.

2 VENT pack

To extract air outside you will need a vent pack. This symbol appears below each product and shows which number vent pack you need to buy. See page 262 for vent packs.

WASH Washable filter

Filters are dishwasher safe – regular washing will provide maximum performance.

25 AMP Electrical connection

This symbol indicates the power supply (amps). This is a guideline only; speak to a qualified electrician.

Manufacturers' guarantees

2yr PARTS 2yr LABOUR

Every appliance is covered by a manufacturer's guarantee for parts and labour. This varies according to the brand and the model. Your legal rights are not affected. Please see individual manufacturer's websites for guarantee details.

90cm range cooker hoods

Designair EXCLUSIVE to B&Q

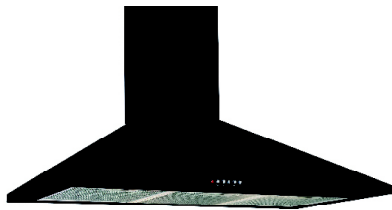

3 AMP 3 SPEED 480 m³/hr 53dBA 2 VENT pack WASH

Chimney hood
H66.5-90.8 x W90 x D47.3cm

- Push button metal controls
- 1 Low energy light

CHK90BK	Black	8422248600576	£193
FILTER		8422248036979	£15.25

bellini think of everything



13 AMP 3 SPEED 550 m³/hr 54dBA 2 VENT pack WASH

Chimney hood
H120 x W90 x D50cm

- Push button controls
- 2 Multispot LED lights

90CHIM	Stainless steel	5052263028241	£352
90CHIM	Black	5052263028210	£352

smeg

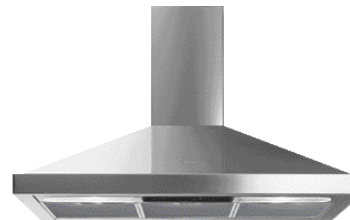

13 AMP 3 SPEED 350 m³/hr 53dBA D+E VENT pack WASH

Chimney hood
H116.5 x W90 x D50cm

- 3 Speeds
- 195w High performance motor
- 2 Halogen lights

KSED92X	Stainless steel	8017709078874	£402
FILTER		8017709037260	£43

smeg



13 AMP 3 SPEED 760 m³/hr 53dBA F VENT pack WASH

90cm traditional range cooker hood
H490-1150 x W90x D48cm

- Push button controls
- 2 x 20w halogen bulbs

KT90P	Cream	8017709182489	£463
KT90BL	Black	8017709182472	£463

Electric Range Cookers

how to shop • in-store • online www.diy.com • phone 0870 0101 006

90cm range cooker hoods

STOVES
 Make a statement

13 AMP **3** SPEED **750** m³/hr **2** VENT **WASH**
Chimney hood
 H120 x W90 x D50cm

5yr PARTS **1yr** LABOUR

- Electronic push button controls
- 2 Multispot LED lights
- 3 Speed settings + booster

S900	Stainless steel	5052263028517	£498
S900	Black	5052263028609	£498

100cm range cooker hoods

Designair EXCLUSIVE to **B&Q**

13 AMP **3** SPEED **750** m³/hr **3** VENT **WASH**
Chimney hood
 H75-104 x W100 x D50cm

2yr PARTS **2yr** LABOUR

- Push button metal controls
- 2 Low energy light

CHP100SS	Stainless steel	8422248604581	£183
CHP100BK	Black	8422248604598	£193

bellini
 think of everything

13 AMP **3** SPEED **550** m³/hr **2** VENT **WASH**
Chimney hood
 H120 x W100 x D50cm

1yr PARTS **1yr** LABOUR

- Push button controls
- 2 Multispot LED lights

100CHIM	Black	5052263028227	£354
100CHIM	Stainless steel	5052263028258	£354

STOVES
 Make a statement

13 AMP **3** SPEED **750** m³/hr **2** VENT **WASH**
Chimney hood
 H120 x W100 x D50cm

5yr PARTS **1yr** LABOUR

- Electronic push button controls
- 2 Multispot LED lights

S1000	Stainless steel	5052263028524	£498
S1000	Black	5052263028616	£498

110cm range cooker hoods

cata

3 AMP **3** SPEED **740** m³/hr **2** VENT **WASH**
Chimney hood
 H66-106 x W110 x D50cm

2yr PARTS **2yr** LABOUR

- Push button controls
- 2 halogen lights
- Aluminium washable filters

CH110SS	Stainless steel	8422248658377	£302
CH110BK	Black	8422248658384	£278

smeg

13 AMP **3** SPEED **760** m³/hr **2** VENT **F**
Traditional range cooker hood
 H90 x W110 x D53.2cm

2yr PARTS **2yr** LABOUR

- High performance motor 210w
- 2 Halogen lights

KT110P	Cream	8017709173074	£532
KT110BL	Black	8017709173067	£532
FILTER		8017709176310	£29

splashbacks



Splashback H75 x W90/100/110cm Stainless steel

■ Can be fitted with any appliance

1 yr
PARTS

1 yr
LABOUR

SPL90	90cm	5034700495243	£198
SPL100	100cm	5034700495274	£237
SPL110	110cm	5034700495304	£245



Splashback H75 x W90/100/110cm Black

■ Can be fitted with any appliance

1 yr
PARTS

1 yr
LABOUR

SPL90BLK	90cm	5034700495267	£207
SPL100BLK	100cm	5034700495298	£234
SPL110BLK	110cm	5034700495328	£234



Splashback with rail H75 x W90/100/110cm Stainless steel

■ Can be fitted with any appliance ■ Utensils not included

1 yr
PARTS

1 yr
LABOUR

SPL90R	90cm	5034700495250	£207
SPL100R	100cm	5034700495281	£234
SPL110R	110cm	5034700495311	£257



Splashback H75 x W90/100/110cm Stainless shimmer

■ Can be fitted with any appliance ■ Self adhesive

1 yr
PARTS

1 yr
LABOUR

SBK90	90cm	5052263029125	£218
SBK100	100cm	5052263029132	£234
SBK110	110cm	5052263029149	£265



smeg **Splashback** H69 x W89.6cm Stainless steel

■ Can be fitted with any appliance

2 yr
PARTS

2 yr
LABOUR

KIT90X		8017709062910	£203
---------------	--	---------------	-------------



smeg **Glass splashback** H75 x W110cm Cream or black

■ Can be fitted with any appliance ■ Self adhesive ■ Toughened glass

2 yr
PARTS

2 yr
LABOUR

SPG110P	Cream	8017709169657	£234
SPG110NE	Black	8017709169664	£234

KEY
FEATURES
TO LOOK
FOR IN

washing machines

Whether you need a washing machine, a tumble dryer or a space-saving washer-dryer, our range is all designed to be integrated giving a perfect, seamless look to your kitchen or utility room.

How many programmes?

Each of our machines features a variety of programmes for different levels of dirt and for various materials. Look out for 'quick wash' (for speed), 'delicates' (for those special items) 'hand wash' (to save your hands) and 'sports' (for sportswear and shoes).

Time delay

With a time delay function you are in control. Why not programme a wash overnight when electricity may be cheaper?

symbols guide...

Performance

A higher rating gives a better wash/drying performance. Wash is based on tests at 40°C



Wash performance



Dry performance



Load capacity

Drum capacity is measured in kilograms and is based on a cotton load.



Spin speed

Faster spin speeds remove more water from your wash and reduce drying times.



Spin efficiency

The higher the rating the better the performance. 'A' indicates the best performance.



How many programmes?

Look out for the number of programme options available with each machine - programmes such as pre-washes and gentle washes for delicate items.



Hand wash

Models with the Platinum Woolmark symbol are endorsed by the Woolmark Company and are designed to reduce the risk of shrinking, felting or bobbling with hand wash only items.



Quick wash

The quick wash function is ideal for items that just need freshening-up.



Time delay

With an integrated delay timer you can run your washing machine overnight when electricity may be cheaper.



Half load

This function allows you to wash smaller loads on a setting that uses less energy and water.



Child safety lock

This clever safety feature allows you to lock the controls so that tiny hands can't turn the appliance on whilst your back is turned.



Water consumption

Measured in litres and based on a standard 40°C cotton cycle, lower consumption machines can save you money on metered water bills.

Energy efficiency



These symbols tell you how energy efficient each appliance is with 'A+++' being the most efficient and 'D' being the least.

Manufacturers' guarantees



Every appliance is covered by a manufacturer's guarantee for parts and labour. This varies according to the brand and the model. Your legal rights are not affected. Please see individual manufacturers' websites for guarantee details.



Washer dryers

A great space-saving solution, all of our washer dryers feature condenser dryers – there's no need to fit a ventilation kit. Fit wherever you have a power supply.



Load capacity

All of our models offer between 6 and 8kg load capacity (more than the standard 5kg). A larger drum size also helps to reduce creasing.



Appliance running costs

To help you decide which appliance is right for you, we've calculated how much each model will cost you to run per year, based on the energy and water it uses. Our results are based on usage rates used to calculate the energy rating label, combined with an electricity rate of 15.32p per kWh and metered water cost of £2.73 per cubic metre (source: Energy Saving Trust England and Wales, checked January 2014). The calculation excludes detergents, soaps, and other disposable materials.

Annual running cost
£40.58

We've highlighted the cheapest appliance to run in each category



INDESITAnnual running cost **£60.66****Built in washing machine**
H82 x W59.5 x D55cm

5yr warranty 1yr door lock

- Easy iron and extra rinse options
- Variable spin speed
- 2 Sports programmes

IWMEB127 White 8007842857122 **£402****COOKE & LEWIS** NEW & EXCLUSIVE

Cheapest to run

Annual running cost **£55.47****Built in washing machine**
H82.5 x W59.5 x D53.5cm

5yr warranty 2yr door lock

- Auto door lock
- Auto adjust amount of water used dependant on weight
- Adjustable thermostat
- Water overflow protection system

CLBIWM-60 White 5052931258543 **£452****BEKO** EXCLUSIVE to B&QAnnual running cost **£68.02****Built in washing machine**
H82 x W59.5 x D54cm

2yr warranty 2yr door lock

- Large display showing time remaining
- Quick 14 minute programme, perfect when you're in a hurry
- Full load wash in 39min with daily quick programme
- Large capacity 8kg

QWM84 White 5023790029360 **£502****Hotpoint** EXCLUSIVE to B&QAnnual running cost **£56.05****Built in washing machine**
H82 x W59.5 x D55cm

5yr warranty 1yr door lock

- Intelligent wash manager customises wash cycles at the touch of a button
- Our unique anti-stain technology removes 20 of the most difficult stains, delivering the perfect wash every time
- Powerful anti-allergy action, removes all major allergens Certified by Allergy UK
- Water consumption 9039 litres per year

BHWMD732 White 5016108801918 **£508****smeg****Built in washing machine**
H82 x W59.6 x D58cm

2yr warranty 2yr door lock

- 15 min super fast wash
- LCD display
- Auto clean filter
- Automatic variable load

WM112C7 White 8017709137038 **£513****BOSCH**Annual running cost **£62.23****Built in washing machine**
H81.8 x W60 x D57cm

2yr warranty 2yr door lock

- Special programmes: mixed load, wool programme and delicates
- Fully electronic control dial for all wash and special programs
- AquaStop system protects against water damage with lifetime guarantee from Bosch
- Water consumption 10560 litres per year

WIS24140GB White 4242002431116 **£703**

Water consumption figures explained...

Most of the washing machines in our range show water consumption figures per standard cycle at 60°C.

Washing machine models launched since the change in legislation 1st December 2011 show an annual water consumption figure instead. This is based on 220 standard loads per year on the standard cotton cycle (4-5 loads per week).

KEY FEATURES TO LOOK FOR IN

washer dryers & tumble dryers



Built in Washing Machines

Washer dryers

INDESIT



Annual running cost **£174.85**



Built in washer dryer
H82 x W59.5 x D55cm

5yr WARRANTY 1yr LABOUR

- Easy iron and extra rinse options
- Variable spin speed
- 2 Sports programmes

IWDE126 White 8007842624632 **£504**

COOKE & LEWIS NEW & EXCLUSIVE



Annual running cost **£202.90**



Built in washer dryer
H82.5 x W59.5 x D53.5cm

5yr WARRANTY 2yr LABOUR

- Auto door lock
- Auto adjust amount of water used dependant on weight
- Adjustable thermostat
- Water overflow protection system

CLBIWD-60 White 5052931258536 **£567**

Hotpoint



Annual running cost **£183.91**



Built in washer dryer
H82 x W59.5 x D55cm

5yr WARRANTY 1yr LABOUR

- Eco wash option saves 50-70% energy versus a 30°C cycle
- Exclusive Woolmark Platinum accreditation
- Baby cycle removes all stains associated with little ones whilst caring for their delicate clothes

BHWD129 White 5016108717783 **£653**

Tumble dryers

catac NEW & EXCLUSIVE



Annual running cost **£41.67**



Integrated rotary sensing dryer
H86.5-89 x W60 x D53cm

1yr WARRANTY 1yr LABOUR

- 3 Heat settings
- 6 Levels of dryness (ranging from damp dry to cupboard dry) for use with high and low heat, 30 minute 'Freshen up' program
- Rear vent position

TDS60W White 5060316579992 **£298**



Pick up a copy of our...
'you can do it' book
The complete step-by-step book of Home Improvement

For more ideas and know-how visit diy.com/advice

B&Q You can do it

**KEY
FEATURES
TO LOOK
FOR IN**

built in dishwashers

Washing the dishes has never been less of a chore. With a wide range of sizes to suit your lifestyle, you can also choose from fully or semi-integrated to suit your kitchen.

Size and capacity

Each of our dishwashers indicate the number of place settings that they wash – usually between 12-15. Consider that as well as the physical size of the dishwasher. Slimline models offer all standard features and typically wash 9-10 place settings.

Integrated?

A fully-integrated model can be fitted with a cupboard door for a seamless look to your kitchen. Semi-integrated models can be fitted with a drawer-line door to match your cupboards but still reveal the control panel.

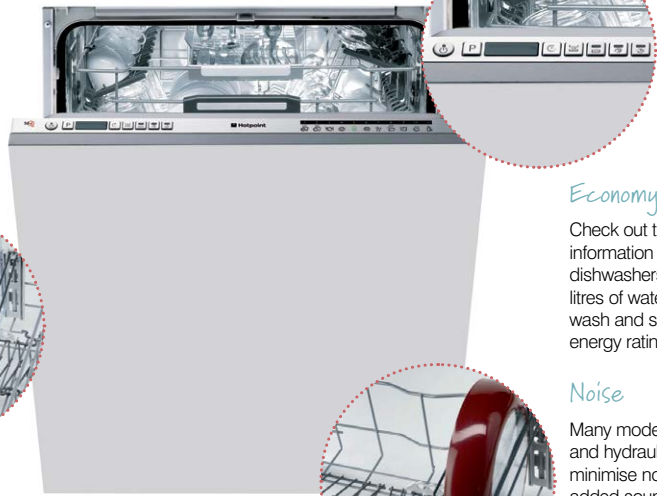

How many programmes?

Many models offer 'quick wash' programmes (for speed) or 'half wash' (for energy efficiency). Some models feature intelligent sensors and motors that detect the level of food debris and wash accordingly.

Economy

Check out the energy information on each of our dishwashers. Some use 6 litres of water or less per wash and some feature energy ratings of A+++.

Noise

Many models feature motors and hydraulics designed to minimise noise as well as added sound insulation built in. Consider the noise level when browsing our range.

Easier loading

Foldable plate racks, removable cutlery baskets and height-adjustable upper baskets are all clever features that you'll find helpful.

symbols guide...

Performance

A higher rating gives a better wash/drying performance. Wash is based on eco programme at 50°C and there are two types of drying action – natural (or residual) and hot air (or active).



Wash performance



Dry performance

Place settings

Full-size dishwashers have room for 12 or more place settings. Slimline dishwashers can fit 9 or 10 place settings. A place setting consists of a cup, a saucer, a bowl, a side plate, a dinner plate and cutlery.

Wash temperature

This indicates the number of temperatures you have to choose from during the wash cycle.

How many programmes?

Look for the number and type of programmes that you'd find useful. The higher the number the more options you have such as pre-washes for burnt on food and delicate washes for glassware.

Time delay

Models with this feature have an integrated delay timer - you can run your dishwasher overnight when electricity may be cheaper.

Half wash

Models with this feature allow you to wash smaller loads on a setting that uses less energy and water.

Water consumption

Measured in litres, lower consumption machines can save you money on metered water bills.

Noise level

Another consideration is the noise level. As an indicator, noise levels around 53dB are good, but some go as low as 41dB; as quiet as a boiling kettle.

Energy efficiency



These symbols tell you how energy efficient each appliance is with 'A+++' being the most efficient and 'D' being the least.

Manufacturers' guarantees



Every appliance is covered by a manufacturer's guarantee for parts and labour. This varies according to the brand and the model. Your legal rights are not affected. Please see individual manufacturers' websites for guarantee details.



Appliance running costs

To help you decide which appliance is right for you, we've calculated how much each model will cost you to run per year, based on the energy and water it uses. Our results are based on usage rates used to calculate the energy rating label, combined with an electricity rate of 15.32p per kWh and metered water cost of £2.73 per cubic metre (source: Energy Saving Trust England and Wales, checked January 2014). The calculation excludes detergents, soaps, and other disposable materials.

Annual running cost **£40.58**

We've highlighted the cheapest appliance to run in each category



Built in dishwashers

cata **EXCLUSIVE to B&Q**



Annual running cost **£61.72**



Built in dishwasher
H82 x W59.6 x D57cm

2yr PARTS 2yr LABOUR

- Sequence indicator
- Adjustable basket
- Quick wash

DWI60 Stainless steel 8422248601481 **£272**

INDESIT **EXCLUSIVE to B&Q**



Annual running cost **£53.60**



Built in dishwasher
H82 x W59.5 x D57cm

5yr PARTS 1yr LABOUR

- Height adjustable upper basket
- Digital display
- Overflow protection

DIFP18B1 UK White 8007842840483
Was £324 Now £299

smeg

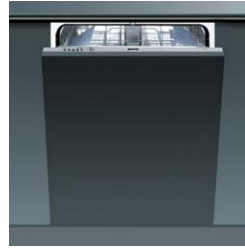

Annual running cost **£53.45**



Built in dishwasher
H81.8 x W59.8 x D55cm

2yr PARTS 2yr LABOUR

- 27 Min rapid wash
- Rear levelling feet, adjustable from the front
- Orbital Wash System with double spray arm

DI6012-1 Stainless steel 8017709174125 **£378**

Hotpoint



Annual running cost **£53.30**



Built in dishwasher
H82 x W59.5 x D57cm

5yr PARTS 1yr LABOUR

- Flexipower motor and sensor system
- Triple stage filtration for superior cleaning performance
- Counterbalanced door for easier unloading and loading

LTB4M116UK White 5016108829110 **£405**

COOKE & LEWIS **NEW & EXCLUSIVE**



Annual running cost **£48.40**



Fully integrated dishwasher
H82 x W59.8 x D55cm

5yr PARTS 2yr LABOUR

- Water softening system
- Overflow protection system
- Electronic controls
- 3x spray levels ■ 3 in 1 function

CLBD-60 White 5052931258482 **£432**

BEKO **EXCLUSIVE to B&Q**



Cheapest to run
Annual running cost **£39.20**



Built in dishwasher
H82 x W59.8 x D54.8cm

2yr PARTS 2yr LABOUR

- Uses only 6L of water to wash a full load of 13 place settings
- Additional cutlery tray at top for extra flexibility
- Quick and clean programme delivers an A class wash for full load in 58 minutes
- Auto programme - adjusts the washing parameters according to the dirtiness of the load

QDW696 White 5023790032346 **£495**

BOSCH



Annual running cost **£53.60**



Built in dishwasher
H81.5 x W59.8 x D55cm

2yr PARTS 2yr LABOUR

- ActiveWater hydraulic system ■ EcoSilence drive
- DosageAssist - maximises the effectiveness of detergent tablets. Detergent dispenser is located in centre of door, where it is protected from food. At beginning of cycle the tablet drops into a special tray for outstanding cleaning results

SMV53A00GB White 4242002643410 **£552**

Built in slimline dishwashers

cata **EXCLUSIVE to B&Q**



Annual running cost
£49.77



Built in slimline dishwasher
H82 x W44.5 x D57cm

2yr PARTS 2yr LABOUR

- Sequence indicator
- Adjustable basket
- Quick wash

DWI45 White 8422248603300 **£257**

INDESIT



Annual running cost
£48.70



Built in slimline dishwasher
H82 x W44.5 x D55cm

5yr PARTS 1yr LABOUR

- Height adjustable upper basket
- LED indicators
- Overflow protection

DIS04 White 8007842631753 **£342**

COOKE & LEWIS **NEW & EXCLUSIVE**



Annual running cost
£44.71



Built in slimline dishwasher
H82 x W44.6 x D55cm

5yr PARTS 2yr LABOUR

- 3x spray levels
- Overflow protection system
- Electronic controls
- 3 in 1 function

CLBD-45 White 5052931258475 **£348**

Hotpoint



Annual running cost
£48.70



Built in slimline dishwasher
H82 x W44.5 x D57cm

5yr PARTS 1yr LABOUR

- Triple stage filtration for superior cleaning performance
- Counterbalanced door for easier unloading and loading
- 35 Minute fast wash

LST216A White 5016108631584 **£384**

BEKO **EXCLUSIVE to B&Q**



Annual running cost
£49.78



Built in slimline dishwasher
H82 x W44.8 x D54.8cm

2yr PARTS 2yr LABOUR

- Quick and clean programme delivers an A class wash for full load in 58 minutes
- Auto programme - adjusts the washing parameters according to the dirtiness of the load
- Great basket flexibility - for easy loading and unloading

QDW486 White 5023790029353 **£435**

BOSCH



Annual running cost
£40.58



Built in slimline dishwasher
H81.5 x W44.8 x D55cm

2yr PARTS 2yr LABOUR

- ActiveWater hydraulic system
- DosageAssist
- EcoSilence drive, VarioSpeed

SPV40C00GB White 4242002671413 **£500**

KEY
FEATURES
TO LOOK
FOR IN

built in fridge freezers

Integration is the key to clean, smooth lines in your kitchen. With our fridge freezers designed to be built in, we're sure you'll have the coolest kitchen around.

Storage

Lots of features are designed around you. Wine racks, deep door storage, large salad bins and innovative ice storage devices are all features to look out for.



Anti-bacterial coating

Many models feature this unique layer that prevents the growth of bacteria and ensures that your fridge is the safest place to store your fresh food.

Size and capacity

Traditionally a 50/50 fridge/freezer, we now offer models that are split 60/40 or 70/30 to suit your lifestyle.

We also offer a range of separate under-counter fridges and freezers.



Economy

Every appliance carries an industry standard energy efficiency rating. 'A++' is the most efficient - best for your pocket and the environment.

Controls and features

Either set and forget or choose innovative electronic controls with temperature displays. Look out for frost-free models and those that feature fridge airflow systems, prolonging the life of fresh food.



symbols guide...

Star rating

This shows the operating temperature of the freezer.



Capacity

The capacity of a fridge or freezer is measured in litres – the higher the number, the more space you'll have.



Storage

Consider the space you need for your food. The symbols below show you how many shelves or drawers the fridge/freezer compartments have.



Reversible doors

Most models have a reversible door so you can choose whether they open to the left or right.

Frost free

Circulating cold air around the freezer prevents the build up of ice.

Auto defrost

An intelligent feature that defrosts automatically without ruining the food inside. Regular defrosting means lower energy bills.

Fast freeze

Ideal when you need to freeze larger amounts of fresh food enabling you to lower the temperature of all or part of your freezer.

Safe storage hours

The amount of time that your food will stay frozen in the event of a power cut.

Energy efficiency

These symbols tell you how energy efficient each appliance is with 'A' being the most efficient and 'D' being the least.

Manufacturers' guarantees



Every appliance is covered by a manufacturer's guarantee for parts and labour. This varies according to the brand and the model. Your legal rights are not affected. Please see individual manufacturers' websites for guarantee details.

Appliance running costs

To help you decide which appliance is right for you, we've calculated how much each model will cost you to run per year, based on the energy it uses. Our results are based on usage rates used to calculate the energy rating label, combined with an electricity rate of 15.32p per kWh (source: Energy Saving Trust England and Wales, checked January 2014).

Annual
running
cost
£40.58

We've
highlighted
the cheapest
appliance to
run in each
category

Cheapest
to run

B&Q One Planet Home

50/50 built in fridge freezers

cata **EXCLUSIVE to B&Q**



Annual running cost **£45.50**



50/50 Built in fridge freezer
H177 x W54 x D54cm

2yr PARTS 2yr LABOUR

- LED lighting
- Glass shelves
- Auto defrost fridge

BIFF50A White 8422248603201 **£398**

Indesit



Annual running cost **£43.20**



50/50 Built in fridge freezer
H177.2 x W54.3 x D55cm

5yr PARTS 1yr LABOUR

- 2 Ice trays
- Static 50/50
- Transparent drawer fronts

TINC425AAUK White 8007842844252
Was £435 Now £397

Hotpoint



Annual running cost **£43.20**



50/50 Built in fridge freezer
H177.2 x W54.3 x D55cm

5yr PARTS 1yr LABOUR

- Hygiene+ antibacterial liners
- Wine rack
- Ice Care ice cube storage

HM325NI White 5016108787687 **£485**

cata **EXCLUSIVE to B&Q**



Annual running cost **£45.81**



50/50 Built in fridge freezer
H177 x W54 x D54cm

2yr PARTS 2yr LABOUR

- Bottle rack
- LED lighting

BIFF50FFA White 8422248603225 **£498**

BEKO **EXCLUSIVE to B&Q**



Annual running cost **£42.13**



50/50 Built in frost free fridge freezer
H177 x W54 x D53.5cm

2yr PARTS 2yr LABOUR

- Chiller compartment for safe storage of fresh meat & fish
- Ice bank tray to make and store ice cubes
- Heavy duty self closing hinges
- Chrome wine rack

QC55F White 5023790032209 **£498**

COOKE & LEWIS **NEW & EXCLUSIVE**



Annual running cost **£47.79**



50/50 Frost Free Built in fridge freezer
H177.3 x W55.5 x D54cm

5yr PARTS 2yr LABOUR

- Frost Free
- True frost free fridge compartment
- LED lighting system
- Humidity controllable salad crisper drawer
- Ice cube and eggs storage compartments

CLBC-50 White 5052931258512 **£573**

BOSCH



Annual running cost **£43.97**



50/50 Built in fridge freezer
H177.2 x W54.1 x D54.5cm

2yr PARTS 2yr LABOUR

- Integrable, sliding hinge
- Automatic defrost in fridge section
- Antibacterial

KIV32X22GB White 4242002763415 **£650**

70/30 built in fridge freezers

cata **EXCLUSIVE to B&Q**



Annual running cost **£43.82**



70/30 Built in fridge freezer
H177 x W54 x D54cm

2yr FREE 2yr WARRANTY

- LED lighting

BIFF70A White 8422248603218 **£382**

cata **EXCLUSIVE to B&Q**



Annual running cost **£44.12**



70/30 Built in frost free fridge freezer
H177 x W54 x D54cm

2yr FREE 2yr WARRANTY

- Bottle rack
- LED lighting

BIFF70FFA White 8422248603232 **£468**

i **INDESIT**



Annual running cost **£42.44**



70/30 Built in fridge freezer
H177 x W54 x D54.8cm

5yr FREE 1yr WARRANTY

- Big salad crisper
- Ice tray

QCB31AA White 8007842852639 **£472**

BEKO **EXCLUSIVE to B&Q**



Annual running cost **£41.98**



70/30 Built in frost free fridge freezer
H177 x W54 x D53.5cm

2yr FREE 2yr WARRANTY

- Antibacterial door seals
- Wine rack
- Chrome bottle retainer
- Heavy duty self closing hinges

QC75F White 5023790032216 **£498**

Hotpoint



Annual running cost **£42.44**



70/30 Built in fridge freezer
H177 x W54 x D55cm

5yr FREE 1yr WARRANTY

- Hygiene+ antibacterial liners
- Wine rack
- Fresh box

HM31AA White 5016108778951 **£547**

COOKE & LEWIS **NEW & EXCLUSIVE**



Annual running cost **£45.96**



70/30 Built in fridge freezer
H177.3 x W55.5 x D54cm

5yr FREE 2yr WARRANTY

- Frost free
- True frost free fridge compartment
- LED lighting system
- Humidity controllable salad crisper drawer
- Ice cube and eggs storage compartment

CLBC-70 White 5052931258529 **£548**

BOSCH



Annual running cost **£42.28**



70/30 Built in fridge freezer
H177.2 x W54.1 x D54.5cm

2yr FREE 2yr WARRANTY

- Fully integrated with special hinged door
- Automatic defrost in fridge section
- Antibacterial

KIV38X22GB White 4242002763200 **£647**

All guarantees are manufacturer guarantees. This does not affect your legal rights.

KEY
FEATURES
TO LOOK
FOR IN

built in fridges

INDESIT



Annual running cost
£19.61



Built in larder fridge
H87.5 x W54 x D57.5cm



- Glass shelves
- Salad crisper
- Egg holder

QS1612 White 8007842855272 £304

cata **EXCLUSIVE to B&Q**



Annual running cost
£23.89



Built in tall fridge
H177 x W54 x D54cm



- Glass shelves
- 2 Salad crispers
- LED light

BIF77A White 8422248603256 £448

Built under fridges

cata **EXCLUSIVE to B&Q**



Annual running cost
£18.84



Built under larder fridge
H81.6-87 x W59.6 x D55cm



- Glass shelves
- Salad crisper
- Egg rack

BU60LFA White 8422248603270 £248

cata **EXCLUSIVE to B&Q**



Annual running cost
£28.18



Built under fridge with ice box
H81.6-87 x W59.6 x D55cm



- Glass shelves
- Ice box
- Salad crisper

BU60RFA White 8422248603287 £278

COOKE & LEWIS **NEW & EXCLUSIVE**



Annual running cost
£18.84



Built under larder fridge
H86.8 x W59.6 x D55cm



- Glass shelves
- Salad crisper
- Egg holder

CLBULF-60 White 5052931258499 £278

INDESIT



Annual running cost
£19.15



Built under larder fridge
H81.5 x W58 x D54.5cm



- Glass shelves
- Salad crisper
- Egg holder

QTS1612 White 8007842855265 £302

Built in Fridge Freezers

BEKO EXCLUSIVE TO **B&Q**



Cheapest to run
Annual running cost **£18.08**



Built under larder fridge
H82 x W59.8 x D54.5cm

2yr parts 2yr labour

- Antibacterial door seals
- Telescopic crisper cover
- Chrome bottle retainer
- Half depth glass shelf

QL22 White 5023790032186 **£327**

Hotpoint



Annual running cost **£19.15**



Built under larder fridge
H81.5 x W58 x D54.5cm

5yr parts 1yr labour

- Safety glass shelves

HUL1622 White 5016108778203 **£345**

BOSCH



Cheapest to run
Annual running cost **£18.08**



Built under larder fridge
H82 x W59.8 x D54.8cm

2yr parts 2yr labour

- Automatic defrost in fridge section
- Height adjustable feet in the front
- 3 Height adjustable safety glass shelves

KUR15A50GB White 4242002650173 **£427**

Pick up a copy of our...
'you can do it' book
The complete step-by-step book of Home Improvement

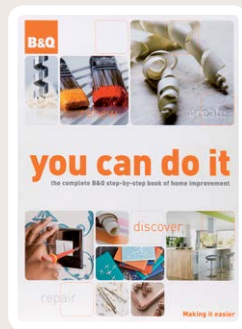

For more ideas and know-how visit diy.com/advice



KEY
FEATURES
TO LOOK
FOR IN

built in freezers



INDESIT



Annual running cost
£30.49



Built in freezer
H87.5 x W54.3 x D55cm



- Temperature indicator
- 2 Ice trays

INF1412 White 8007842838251 **£302**

cata EXCLUSIVE to B&Q



Annual running cost
£44.43



Built in tall freezer
H177 x W54 x D54cm



- Transparent drawers
- LED lighting

BIFZ177A White 8422248603249 **£448**

Built under freezers

cata EXCLUSIVE to B&Q



Annual running cost
£29.72



Built under freezer
H81.5 x W59.6 x D54.5cm



- Transparent drawers

BU60FZA White 8422248603263 **£258**

COOKE & LEWIS NEW & EXCLUSIVE



Annual running cost
£29.41



Built in under freezer
H87.5 x W54 x D57.5cm



- Electronic display
- Ice cube tray
- Transparent food drawers

CLBUF-60 White 5052931258505 **£295**

INDESIT



Cheapest to run
Annual running cost
£28.19



Built under freezer
H81.5 x W58 x D54.5cm



- Temperature indicator
- Ice tray

TINFS1212K White 8007842855241 **£324**

BEKO EXCLUSIVE to B&Q



Annual running cost
£28.50



Built under freezer
H82 x W59.8 x D54.5



- Antibacterial door seals
- Handy door rack
- High temperature warning light
- Fast freeze function

QZ32 White 5023790032193 **£354**

Built in Fridge Freezers

how to shop • in-store • online www.diy.com • phone 0870 0101 006

Hotpoint



Annual running cost **£34.42**



Built under freezer
H81.5 x W58 x D54.5cm

5yr PARTS 1yr LABOUR

- Ice tray

HUZ1222.1 White 5016108838266 **£403**

BOSCH



Cheapest to run

Annual running cost **£28.19**



Built under freezer
H82 x W59.8 x D54.8cm

2yr PARTS 2yr LABOUR

- Temperature indicator on inside of door
- Super freezing with manual switch off
- Height adjustable feet in the front

GUD15A50GB White 4242002650890 **£427**



Wine coolers

cata EXCLUSIVE to B&Q



Wine cooler
H87-89 x W15 x D52.5cm

1yr PARTS 1yr LABOUR

- Bottle capacity: 7
- Soft interior light
- LED controls
- Toughened UV protection glass door

WC300 Stainless steel effect 8422248603331 **£248**

cata EXCLUSIVE to B&Q



Wine cooler
H87-89 x W29.5 x D57cm

1yr PARTS 1yr LABOUR

- Bottle capacity: 18
- LED controls
- Toughened UV protection glass door
- Fan assisted operation

WC300 Stainless steel effect 8422248600026 **£248**

cata EXCLUSIVE to B&Q



Wine cooler
H87-89 x W15 x D52.2cm

1yr PARTS 1yr LABOUR

- Bottle capacity: 7
- Soft interior light
- Adjustable chrome shelves
- Digital thermostat

WC150BK Black / St/steel 8422248605557 **£285**

cata EXCLUSIVE to B&Q



Wine cooler
H87-89 x W29.5 x D57cm

1yr PARTS 1yr LABOUR

- Bottle capacity: 18
- Soft interior light
- Adjustable chrome shelves
- Digital thermostat

WC300BK Black / St/steel 8422248605571 **£304**

All guarantees are manufacturer guarantees. This does not affect your legal rights.

**KEY
FEATURES
TO LOOK
FOR IN**

side by side **fridge freezers**

For lots of capacity and innovative features, our side by side fridge freezers have it all. Take a look at some of the features below and choose a model that suits your kitchen and your lifestyle.

LED display

An electronic touch control LED display gives you complete control at your fingertips without ever having to open fridge or freezer door, saving you energy and time.



Wine rack

A stylish, elegant and safe way to store your wine bottles. Also suitable for standard 2 litre soft drink bottles. Take a look at this and other innovative features on offer.

Chiller zone compartment

Stores fresh meat, fish, cooked and chilled food at around 0°C for safer and longer storage.



Water and ice

Many of our side by side fridge freezers feature an integrated dispenser for instant access to chilled water and / or ice.

Dual cooling system

Independent cooling systems ensure a high humidity level in the fridge to prolong the life of fresh fruit and vegetables.

symbols guide...

Star rating

This shows the operating temperature of the freezer. Four star freezers also come with a quick freeze feature.



Capacity

The capacity of a fridge or freezer is measured in litres – the higher the number, the more space you'll have.



Storage

Consider the space you need for your food. The symbols below show you how many shelves or drawers the fridge/freezer compartments have.



Frost free

Circulating cold air around the freezer prevents the build up of ice.

Auto defrost

An intelligent feature that defrosts automatically without ruining the food inside. Regular defrosting means lower energy bills.

Fast freeze

Ideal when you need to freeze larger amounts of fresh food enabling you to lower the temperature of all or part of your freezer.

Safe storage hours

The amount of time that your food will stay frozen in the event of a power cut.

Energy efficiency



These symbols tell you how energy efficient each appliance is with 'A' being the most efficient and 'D' being the least.

Manufacturers' guarantees



Every appliance is covered by a manufacturer's guarantee for parts and labour. This varies according to the brand and the model. Your legal rights are not affected. Please see individual manufacturers' websites for guarantee details.

Appliance running costs



To help you decide which appliance is right for you, we've calculated how much each model will cost you to run per year, based on the energy it uses. Our results are based on usage rates used to calculate the energy rating label, combined with an electricity rate of 15.32p per kWh (source: Energy Saving Trust England and Wales, checked January 2014).

Annual running cost £40.58

We've highlighted the cheapest appliance to run in each category



BEKO



Piano black finish features long bar handles

Annual running cost **£68.48**



Side by side US style fridge freezer
H179 x W92 x D72cm **1 yr parts 1 yr labour**

- Dual cooling system maintains the optimal environment in the fridge and freezer
- Chilled, filtered water and ice on tap
- Chiller zone for the safe storage of fresh meat and fish

GNEV321APX	Stainless steel effect	5023790027007	£798
GL32APB	Piano black	5023790026604	£852

BEKO



Multizone compartment

Annual running cost **£69.71**



Four door US style fridge freezer
H182 x W92 x D72cm **1 yr parts 1 yr labour**

- Multizone compartment can be used as either a fridge or freezer
- Active fresh blue light prolongs the storage life of fruit and vegetables
- Cool air vents maintain an even temperature on every shelf

GNE114610APX	Stainless steel effect	5023790028189	£1098
---------------------	------------------------	---------------	--------------

SAMSUNG



Annual running cost **£61.92**



Side by side US style fridge freezer
H178 x W90.8 x D68.7cm (excluding handle) **2 yr parts 2 yr labour**

- Fit more food and shop less, thanks to higher storage capacity
- Enjoy fresh filtered water and ice from the built in dispenser
- Multi-flow keeps food safely and evenly preserved

RGS5UUBP	Gloss black	8806085125414	£1253
-----------------	-------------	---------------	--------------

SAMSUNG



Annual running cost **£78.74**



Side by side US style fridge freezer
H178 x W90.8 x D68.7cm (excluding handle) **2 yr parts 2 yr labour**

- Fit more food and shop less, thanks to higher storage capacity
- Enjoy fresh filtered water and ice from the built in dispenser
- Multi-flow keeps food safely and evenly preserved

RGS5UURS1	Stainless steel effect	8806071759357	£1354
------------------	------------------------	---------------	--------------

Doing our bit for energy efficiency

All our fridges, freezers, dishwashers, washing machines and single ovens are at least A rated – and you'll find some as high as A+++ rated.

Behind the scenes at B&Q, we've been working closely with our suppliers to make our kitchen appliances more energy efficient. Replacing old appliances with our energy efficient models will help to keep the running costs of your new kitchen down. To save even more, use timers on washing machines and dishwashers to wash at off-peak electricity times of day and try to avoid half loads.

You can do your bit to reduce the pace of climate change - reduce your energy consumption to reduce your carbon emissions.

B&Q One Planet Home
a big plan for a small planet

KEY
FEATURES
TO LOOK
FOR IN

fridge freezers

When choosing the right fridge freezer for you, consider a model that suits your lifestyle and the space you have available.



A++ energy rating

For greater efficiency, choose a model with the highest rating. Not only will you be helping the environment, you'll also be helping your pocket.

Configurations

Consider the food that you regularly keep cool. Our fridge freezer range offers various configurations depending on whether you need more fridge or more freezer. Look at 50/50, 60/40 or 70/30 splits.



Frost free

Air is circulated around the appliance and prevents frost from forming – no more time spent scraping ice off your freezer elements.



Fast freezing option

A useful feature to look out for – it's ideal for when you want to freeze a large quantity of fresh food.

Maximised space

A variety of clever storage options help you to make the best use of your fridge freezer. Wine racks, adjustable shelves and deep door storage are all features to help you.





60/40 fridge freezers



Annual running cost £35.08



Temperature displays

2yr PARTS 2yr LABOUR

60/40 fridge freezers ¹			
Finish	Black	Cream	Red
Dimensions	H192.6 x W60 x D68.2cm (excluding handle)		
Right hand hinge [*]			
Model	FAB32RNN	FAB32RNC	FAB32RNR
EAN	8017709174736	8017709174750	8017709174798
Price	£1503	£1503	£1503
Left hand hinge [*]			
Model	FAB32LNN	FAB32LNC	FAB32LNR
EAN	8017709174743	8017709174767	8017709174804
Price	£1503	£1503	£1503

70/30 fridge freezers



Cheapest to run

Annual running cost £32.48



Iconic design

2yr PARTS 2yr LABOUR

70/30 fridge freezers ¹				
Finish	Black	Cream	Red	Silver
Dimensions	H168.8 x W60 x D68.2cm (excluding handle)			
Right hand hinge [*]				
Model	FAB30RFN	FAB30RFC	FAB30RFR	FAB30RFS
EAN	8017709174552	8017709174576	8017709174439	8017709174538
Price	£1302	£1302	£1302	£1302
Left hand hinge [*]				
Model	FAB30LFN	FAB30LFC	FAB30LFR	FAB30LFS
EAN	8017709174569	8017709174583	8017709174446	8017709174545
Price	£1302	£1302	£1302	£1302

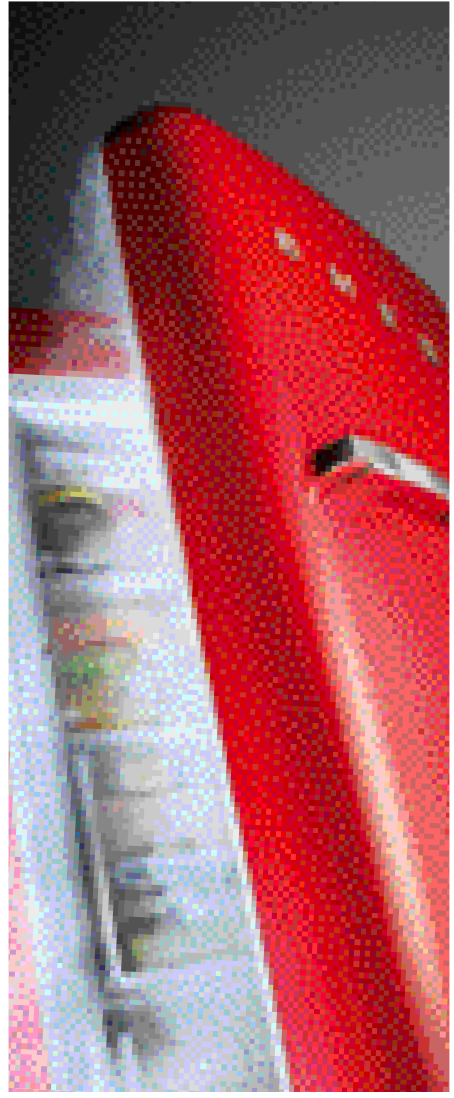

Freestanding fridge freezers

¹When positioning these appliances adjacent to a wall or kitchen unit, a gap of 175mm must be left on the hinged side of the product to allow the door to open.
^{*}Please note that these doors are not reversible, therefore ensure you order the corrected handed model.

All guarantees are manufacturer guarantees. This does not affect your legal rights.

Freestanding fridges

smeg



■ Iconic design

Annual running cost
£27.58

2yr PARTS 2yr LABOUR

50's freestanding refrigerator with ice box†					
Finish	White	Black	Cream	Red	Silver
Dimensions	H151 x W60 x D68.2cm (excluding handle)				
Right hand hinge*					
Model	FAB28QB1	FAB28QNE1	FAB28QP1	FAB28QR1	FAB28QX1
EAN	8017709157746	8017709158026	8017709158101	8017709158149	8017709158347
Price	£987	£987	£987	£987	£987
Left hand hinge*					
Model	FAB28YB1	FAB28YNE1	FAB28YP1	FAB28YR1	FAB28YX1
EAN	8017709157753	8017709158033	8017709158118	8017709158156	8017709158354
Price	£987	£987	£987	£987	£987

Freestanding freezers

smeg



■ Iconic design ■ Acoustic alarm
■ Freezer shelves have pull down fronts

Annual running cost
£34.16

2yr PARTS 2yr LABOUR

50's freestanding upright freezer†			
Finish	Black	Cream	Red
Dimensions	H151 x W60 x D68.2cm (excluding handle)		
Right hand hinge*			
Model	CVB20RNE	CVB20RP	CVB20RR
EAN	8017709181483	8017709181437	8017709181451
Price	£1302	£1302	£1302
Left hand hinge*			
Model	CVB20LNE	CVB20LP	CVB20LR
EAN	8017709181420	8017709181444	8017709181468
Price	£1302	£1302	£1302



Perfect partners.
Side by side the Smeg
fridge and freezer are
made for each other



*When positioning these appliances adjacent to a wall or kitchen unit, a gap of 175mm must be left on the hinged side of the product to allow the door to open.
†Please note that these doors are not reversible, therefore ensure you order the corrected handed model.

freestanding appliances

COOKE
& LEWIS



Freestanding microwave
H258 x W440 x D293mm

2yr
PARTS 2yr
LABOUR

- Grill function
- 8 preset cooking functions
- End cooking signal
- S/steel cavity
- LED programmer & clock

CLM1W-C Black & Stainless steel 5052931055708 **£62**

COOKE
& LEWIS



Freestanding fridge with ice box
H839 x W486 x D536mm

2yr
PARTS 2yr
LABOUR

- Adjustable levelling feet
- 2x Door shelves
- 42 dbA noise level
- 3x internal shelves
- 1x Built in egg rack
- 109 kWh/ annum

CLRF101A White 5052931237968 **£153**

Annual
running
cost
£14.74

COOKE
& LEWIS



Freestanding freezer
H839 x W486 x D536mm

2yr
PARTS 2yr
LABOUR

- Adjustable levelling feet
- 3x Pull out clear drawers
- 42 dbA noise level
- 172 kWh/ annum

CLFS71A White 5052931237951 **£172**

Annual
running
cost
£14.74

COOKE
& LEWIS



Freestanding slimline dishwasher
H850 x W450 x D600mm

2yr
PARTS 2yr
LABOUR

- Adjustable feet
- Adjustable upper basket
- Water overflow protection system
- Cold fill

CLDW451W-C White 5052931055623 **£234**

Annual
running
cost
£49.00

COOKE
& LEWIS



Freestanding dishwasher
H850 x W600 x D600mm

2yr
PARTS 2yr
LABOUR

- Adjustable feet
- Adjustable upper basket
- Water overflow protection system
- Cold fill

CLDW601W-C White 5052931055630 **£245**

Annual
running
cost
£61.72

Clearance

Limited stock available, subject to availability



480 m³/hr
55dB(A)
WASH

Deluxe angled glass chimney hood

AGHD71SS Stainless steel
8422248027946 Was £62 Now £29



480 m³/hr
55dB(A)
WASH

Angled glass chimney hood

AGHD61BK Black
8422248027885 Was £74 Now £49

A 59ltr MAIN 5 minute minder

CATA multifunction single oven

A60BKM Stainless steel
8422248603355 Was £249 Now £149



CATA 5 burner gas on glass hob

GH70GGWH White
8422248604284 Was £186.75 Now £99



Curved splashback

Stainless steel
8422248029353 Was £17.25 Now £10



3 AMP 3 SPEED 451 m³/hr 70dB(A) 3 VENT HOLES

Indesit chimney hood

IHP6.5FCMIX Stainless steel
8007842836424 Was £179 Now £129

WPRO carbon filter

CHF180B 8015250043440 Now 50p

Chimney hood vent kit

5025348302000 Now £1

WPRO hood filter

8015250023848 Now £1

A 59ltr MAIN 5 minute minder

CATA multifunction single oven

A3MULTI Stainless steel
8422248602396 Was £279 Now £199

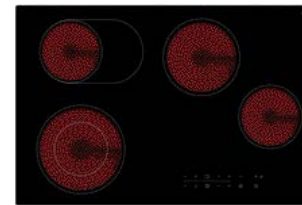

CATA 77cm ceramic hob

- Touch controls with timer
- Dual zone options
- Quickstart zones

EC77TC Black
8422248602402 Was £171 Now £99



70cm curved glass splashback

CSB70SS Stainless steel
8422248032360 Was £27.14 Now £15

Clearance

after sales service

Although we pride ourselves on an excellent track record, very occasionally things do go wrong. If you have a problem with your appliance, you should follow the procedure below, which will ensure we rectify the situation as quickly as possible.

For damages or returns

Please contact our Home Delivery Centre on 0800 389 5516. Damages should be reported as soon as possible but no later than 28 days from receipt of delivery. Please do not install the product if you know it is damaged.

If a fault develops once your appliance is fitted

You should contact the manufacturer direct. They will arrange for an engineer to visit your home – usually within 48 hours – to carry out the necessary repairs. If the appliance is not repairable, they will arrange delivery and fitting of a free replacement. Please note this service is only available within the guarantee period. Appliances must be fitted by an installer with the required registration for gas or electrical work, who complies with all current regulations.

don't
forget...

Spares and accessories service

We are now able to help you replace your spare parts at the click of a button, visit www.diy-spares.com. With over 1.4 million items, delivered direct in 2-7 days* and featuring over 270 brands including Bosch, Whirlpool, Indesit, Hotpoint and Zanussi, you can shop by brand, product or even use our parts enquiry service.

Visit **www.diy-spares.com** today!

* Delivery in 2-7 days. Express Delivery Service (next day) offered at additional cost. B&Q is pleased to offer this service in partnership with diy-spares.com. All transactions will appear as [diy-spares](http://diy-spares.com) on your invoice and credit card statement.



01189 336958

Mon-Fri 8am to 6pm
Sat 9am to 2pm
Sun Closed
Warranty – Black line: 5 years parts & labour. Other: 5 years parts & 2 years labour



0845 600 4911

Mon-Fri 8am to 8pm
Sat-Sun 10am to 4pm
www.beko.co.uk &
www.leisurecooker.co.uk
Warranty – Built in: 2 year.
Free standing: 1 year



0844 815 3746

Mon-Fri 8am to 6pm
Sat 8.30am to 2pm
Sun 10am to 2pm
www.belling.co.uk
Warranty – 1 year parts & labour



0844 892 8979

Mon-Fri 8am to 8pm
Sat 8am to 4pm
Sun/Bank Hol 9am to 3pm
www.bosch-home.co.uk
Warranty – 2 years parts & labour



0844 800 1128

Mon-Fri 8am to 8pm
Sat 9am to 1pm
uksupport@apelson.co.uk

Warranty – Designair: 1 year parts & labour. Cata or unbranded have either 1 or 2 years, see product for details



0844 800 1128

Mon-Fri 8am to 8pm
Sat 9am to 1pm
uksupport@apelson.co.uk

Warranty – Cooke & Lewis is either 2 years parts and labour or 5 years parts & 2 years labour, see product for details



0844 822 4224

Mon-Fri 8am to 6.30pm
Sat 8.30am to 5.30pm
Sun 9.30am to 3.30pm
www.hotpointservice.co.uk
Warranty – 5 years parts & 1 year labour



0844 822 4224

Mon-Fri 8am to 6.30pm
Sat 8.30am to 5.30pm
Sun 9.30am to 3.30pm
www.indesit.co.uk
Warranty – 5 years parts & 1 year labour



0844 815 3747

Mon-Fri 8am to 6pm
Sat-Sun 10am to 2pm
www.newworldappliances.co.uk
Warranty – 1 year parts & labour



0330 726 7864

Mon-Sat 9am to 6pm
www.samsung.co.uk
Warranty – 2 years parts & labour except 1 year on microwaves, 2 years labour 5 years parts on 7/8/9kg washing machines



0844 557 9907

Mon-Fri 9am to 5pm
Sat 9am to 1pm
www.smeg-service.co.uk
Warranty – 1 year parts & labour



0844 815 3740

Mon-Fri 8am to 6pm
Sat 8.30am to 2pm
Sun 10am to 2pm
www.stoves.co.uk
Warranty – 5 years parts & 1 year labour

ways to pay

At B&Q you can pay by Visa, Mastercard, Switch, Delta and Maestro debit and credit cards.



Price promise

If you find any product even 1p cheaper somewhere else... we'll refund the difference and give you an extra 10% off the lower price.

We're so confident our prices in store are cheaper than our competitors, that if you buy a product from us and find the same product (or the equivalent in the case of B&Q Brand) available locally (within a 10 mile radius) for less – even if it's a sale or special offer price – we'll not just match that price but we'll beat the lower price by a further 10% for your trouble.

All we ask is that the lower price is generally available to any potential customer on the day that you call back, within 14 days of purchase, with a proof of purchase.

The product must be available to the general public. We do not Price Promise against: Retail, Wholesale or Warehouse Clubs requiring membership, Internet or mail order companies, TradePoint and companies within the Kingfisher Group e.g. Screwfix, Services e.g. Installation, Delivery Charges and Chargeable Cutting Service, Staff Discount Card holders (including Group discount) can have a Price Promise or use their 20% Discount Card, not both. TradePoint does not operate a price match policy with our competitors. (TradePoint prices are lower or level with B&Q).

Delivery



Available by home delivery

Items with this logo are available to order for delivery direct to your home*. Delivery times vary depending on the product so please ask at the time of ordering.

Delivery from our specialist delivery team

Order Value††	Delivery charge
£0 - under £100	£5
£100 - under £200	£10
£200 - under £250	£15
Over £250	FREE

Goods ordered online at diy.com

A £5 flat rate delivery fee applies to all home delivery orders placed on diy.com. This applies to all items, including those available for next day delivery.

*All guarantees are manufacturers guarantees. This does not affect your legal rights.



Products with this logo are available to take home today from all of our stores (dependent on stock).



Our Banbury, Bedford, Burgess Hill, Bognor Regis, Consett, Eastleigh, Fareham, Hedge End, Nursling, Poole, Portsmouth, Port Glasgow and Sydenham stores stock a wide range of products – all available to take away. The symbol is used throughout this Buying Guide to indicate the products that these stores stock. However these are subject to availability and ranges may vary by store.

Delivery from our store delivery team

Order Value††	Delivery charge
£0 - £250	£20
Over £250	FREE

*Delivery charges apply. Delivery charges and availability may vary in Northern Ireland and offshore stores for some products marked for home delivery. Some items may only be available for collection from store and some items may not be available to purchase online. You will be advised at the time of placing your order.

†† Charges refer to the value of goods being delivered and exclude services.

Product detail

All products are subject to availability. All specifications are correct at time of print. Whilst we try to ensure accurate colour representation, please be aware that the photographic process may sometimes alter colours. Some items in our photographs are included for display purposes and are not necessarily intended to be installed as shown with regard to proximity. Please refer to the instructions supplied with your product before installation. A summary of this price guide is available in Braille, large print or on audio cassette. Please ask at your local store for details or email us at diversity@b-and-q.co.uk

At B&Q we have a number of different finance options to suit your needs which could help you fund your purchase.

To see how our finance products could help make your dream project more achievable, just visit your local store and ask a member of staff for details or visit diy.com

Credit subject to status. B&Q acts as a credit broker. The credit advertised is provided by Hitachi Capital Consumer Finance with whom we have a commercial relationship.

Our returns policy

Please keep your receipt for anything you buy from us. It will ensure we can help you, if you need to bring something back.

Terms and conditions

If you return a product unused, with the original receipt within 45 days of purchase (or delivery where applicable) we will exchange the product or issue a refund based on the original method of payment. For purchases made by debit/credit card, the same card must be used to process the refund. B&Q customer sales forms are an acceptable form of receipt.

Products that have been cut, made to measure or mixed to your requirements cannot be exchanged or refunded.

We reserve the right to refuse a return or to require proof of identity.

YOUR CONSUMER RIGHTS ARE NOT AFFECTED

If the product you purchase is faulty, or not as described, we may offer an exchange, refund or repair as appropriate, in accordance with your consumer rights.

You can return your items by:

In the first instance, return via Home Delivery or www.diy.com

■ contact us on 0800 3895516.

Lines are open 8am – 8pm
Monday to Saturday and
10am – 4pm Sunday.
If calling from the Republic of Ireland
please call 1800 946327

■ e-mail us at home.delivery@b-and-q.co.uk

■ write to us at B&Q Customer Services,
Torrance House, Erskine Harbour, Erskine,
Renfrewshire PA8 6PA

Alternatively, return the product to your local B&Q store

■ you will need to take the product, your receipt/sales advice and the debit/credit card you used for payment with you



When you have finished with
this magazine please recycle it.

B&Q plc, Hampshire S053 3LE Visit us at: diy.com BOOK1325 © August 2014 Version 1 (UK stores only)



You can do it